



1 Introduction

For designers of STM32 microcontroller applications, it is important to be able to easily replace one microcontroller type by another one in the same product family. Migrating an application to a different microcontroller is often needed, when product requirements grow, putting extra demands on memory size, or increasing the number of I/Os. On the other hand, cost reduction objectives may force you to switch to smaller components and shrink the PCB area.

This application note is written to help you and analyze the steps you need to migrate from an existing STM32F1 devices based design to STM32F2 devices. It groups together all the most important information and lists the vital aspects that you need to address.

To migrate your application from STM32 F1 series to F2 series, you have to analyze the hardware migration, the peripheral migration and the firmware migration.

To benefit fully from the information in this application note, the user should be familiar with the STM32 microcontroller family. Available from www.st.com.

- The STM32F1 family reference manuals (RM0008 and RM0041), the STM32F1 datasheets, and the STM32F1 Flash programming manuals (PM0075, PM0063 and PM0068).
- The STM32F2 family reference manual (RM0033), the STM32F2 datasheets, and the STM32F2 Flash programming manual (PM0059).

For an overview of the whole STM32 series and a comparison of the different features of each STM32 product series, please refer to AN3364 'Migration and compatibility guidelines for STM32 microcontroller applications'

Contents

- 1 Introduction 1**
- 2 Hardware migration 6**
- 3 Peripheral migration 9**
 - 3.1 STM32 product cross-compatibility 9
 - 3.2 System architecture 12
 - 3.2.1 32-bit multi-AHB bus matrix 12
 - 3.2.2 Adaptive real-time memory accelerator (ART Accelerator™) 12
 - 3.2.3 Dual SRAM 13
 - 3.3 Memory mapping 13
 - 3.4 RCC 16
 - 3.5 DMA 23
 - 3.5.1 Interrupts 26
 - 3.6 GPIO 29
 - 3.6.1 Alternate function mode 30
 - 3.7 EXTI source selection 31
 - 3.8 FLASH 31
 - 3.9 ADC 33
 - 3.10 PWR 35
 - 3.11 RTC 36
 - 3.12 Miscellaneous 37
 - 3.12.1 Ethernet PHY interface selection 37
 - 3.12.2 TIM2 internal trigger 1 (ITR1) remapping 37
- 4 Firmware migration using the library 38**
 - 4.1 Migration steps 38
 - 4.2 RCC 38
 - 4.3 FLASH 40
 - 4.4 GPIO 43
 - 4.4.1 Output mode 43
 - 4.4.2 Input mode 43
 - 4.4.3 Analog mode 43

4.4.4	Alternate function mode	43
4.5	EXTI	45
4.6	DMA	46
4.7	ADC	47
4.8	Backup data registers	49
4.9	Miscellaneous	49
4.9.1	Ethernet PHY interface selection	49
4.9.2	TIM2 internal trigger 1 (ITR1) remapping	50
5	Revision history	51

List of tables

Table 1.	STM32 F1 series and STM32 F2 series pinout differences	6
Table 2.	STM32 peripheral compatibility analysis F1 versus F2 series	9
Table 3.	IP bus mapping differences between STM32 F1 and STM32 F2 series.	13
Table 4.	RCC differences between STM32 F1 and STM32 F2 series	16
Table 5.	Example of migrating system clock configuration code from F1 to F2 series.	20
Table 6.	RCC registers used for peripheral access configuration.	21
Table 7.	DMA request differences between STM32 F1 series and STM32 F2 series	23
Table 8.	Interrupt vector differences between STM32 F1 series and STM32 F2 series.	27
Table 9.	GPIO differences between STM32 F1 series and STM32 F2 series	30
Table 10.	FLASH differences between STM32 F1 series and STM32 F2 series	32
Table 11.	ADC differences between STM32 F1 series and STM32 F2 series	33
Table 12.	PWR differences between STM32 F1 series and STM32 F2 series.	35
Table 13.	STM32F10x and STM32F2xx FLASH driver API correspondence.	41
Table 14.	Document revision history	51

List of figures

Figure 1.	Compatible board design: LQFP144	7
Figure 2.	Compatible board design: LQFP100	7
Figure 3.	Compatible board design: LQFP64	8
Figure 4.	STM32 F2 series system architecture	12

2 Hardware migration

All peripherals shares the same pins in the two families, but there are some minor differences between packages.

In fact, the STM32 F2 series maintains a close compatibility with the whole STM32 F1 series. All functional pins are pin-to-pin compatible. The STM32 F2 series, however, are not drop-in replacements for the STM32 F1 series: the two families do not have the same power scheme, and so their power pins are different. Nonetheless, transition from the STM32 F1 series to the STM32 F2 series remains simple as only a few pins are impacted (impacted pins are in bold in the table below).

Table 1. STM32 F1 series and STM32 F2 series pinout differences

STM32 F1 series				STM32 F2 series			
QFP64	QFP100	QFP144	Pinout	QFP64	QFP100	QFP144	Pinout
5	12	23	PD0 - OSC_IN	5	12	23	PH0 - OSC_IN
6	13	24	PD1 - OSC_OUT	6	13	24	PH1 - OSC_OUT
12	19	30	VSSA		19	30	VDD
	20	31	VREF-	12	20	31	VSSA
31	49	71	VSS_1	31	49	71	VCAP1
	73	106	NC	47	73	106	VCAP2
47	74	107	VSS_2		74	107	VSS2
63	99	143	VSS_3	63			VSS_3

The figures below show examples of board designs that are compatible with both the F1 and the F2 series.

Figure 1. Compatible board design: LQFP144

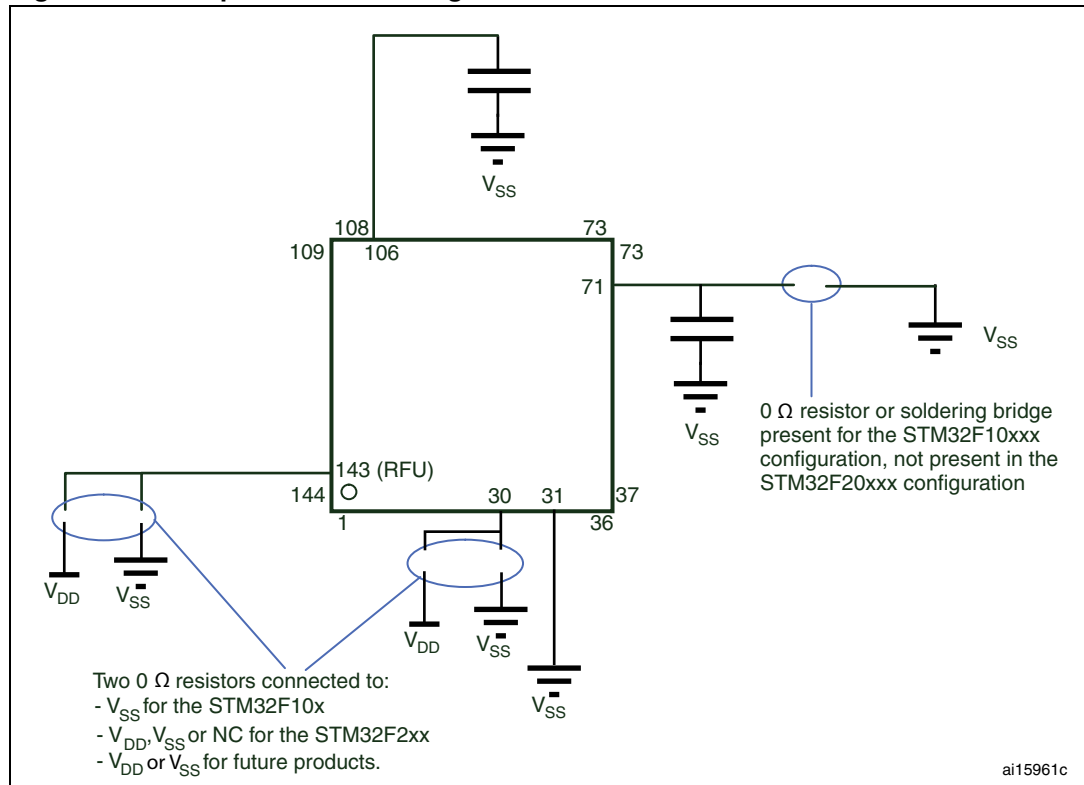

Figure 2. Compatible board design: LQFP100

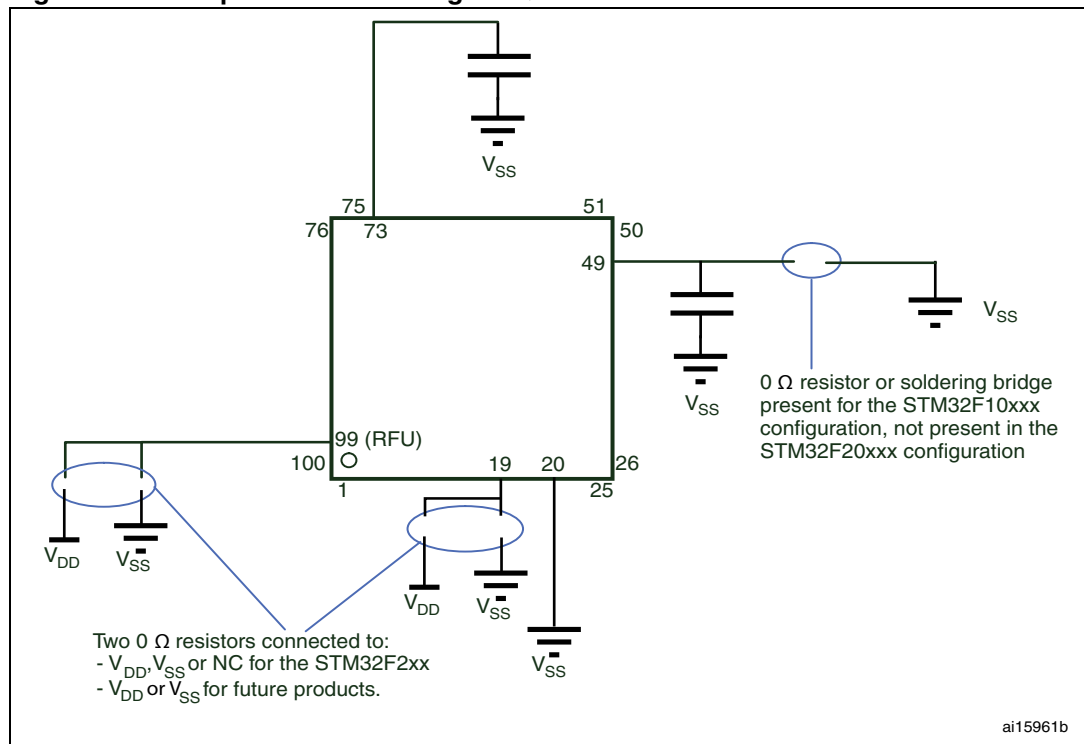
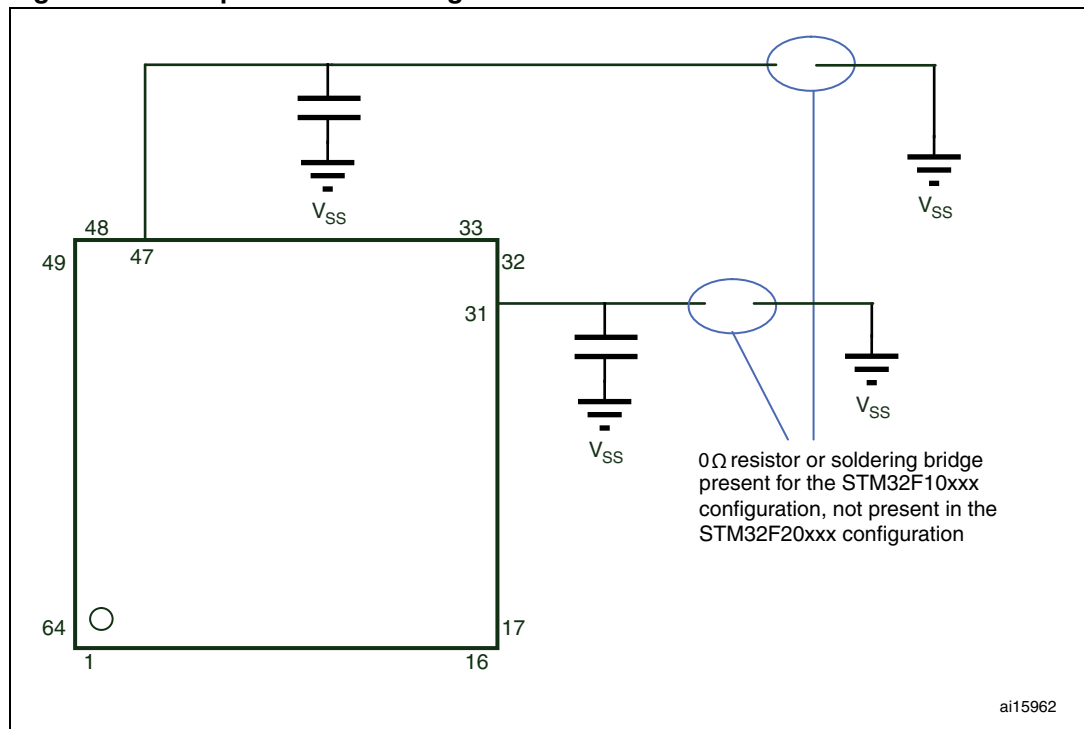

Figure 3. Compatible board design: LQFP64



3 Peripheral migration

As shown in [Table 2 on page 9](#), there are three categories of peripherals. The common peripherals are supported with the dedicated firmware library without any modification, except if the peripheral instance is no longer present, you can change the instance and of course all the related features (clock configuration, pin configuration, interrupt/DMA request).

The modified peripherals such as: FLASH, ADC, RCC, DMA, GPIO and RTC are different from the F1 series ones and should be updated to take advantage of the enhancements and the new features in F2 series.

All these modified peripherals in the F2 series are enhancements in performance and features designed to meet new market requirements and to fix some limitations present in the F1 series.

3.1 STM32 product cross-compatibility

The STM32 series embeds a set of peripherals which can be classed in three categories:

- The first category is for the peripherals which are by definition common to all products. Those peripherals are identical, so they have the same structure, registers and control bits. There is no need to perform any firmware change to keep the same functionality at the application level after migration. All the features and behavior remain the same.
- The second category is for the peripherals which are shared by all products but have only minor differences (in general to support new features), so migration from one product to another is very easy and does not need any significant new development effort.
- The third category is for peripherals which have been considerably changed from one product to another (new architecture, new features...). For this category of peripherals, migration will require new development at application level.

[Table 2](#) below gives a general overview of this classification:

Table 2. STM32 peripheral compatibility analysis F1 versus F2 series

Peripheral	F1 series	F2 series	Compatibility		
			Comments	Pinout	SW compatibility
FSMC	Yes	Yes	Same features	Identical	Full compatibility
WWDG	Yes	Yes	Same features	NA	Full compatibility
IWDG	Yes	Yes	Same features	NA	Full compatibility
DBGMCU	Yes	Yes	Same features	NA	Full compatibility
CRC	Yes	Yes	Same features	NA	Full compatibility
EXTI	Yes	Yes	Same features	Identical	Full compatibility
CAN	Yes	Yes	Same features	Identical	Full compatibility



Table 2. STM32 peripheral compatibility analysis F1 versus F2 series (continued)

Peripheral	F1 series	F2 series	Compatibility		
			Comments	Pinout	SW compatibility
PWR	Yes	Yes+	Enhancement	NA	Full compatibility for the same feature
RCC	Yes	Yes+	Enhancement	NA	Partial compatibility
SPI	Yes	Yes+	TI mode / Max baudrate	Identical	Full compatibility for the same feature
USART	Yes	Yes+	Limitation fix / Max baudrate / One Sample Bit / Oversampling by 8	Identical	Full compatibility for the same feature
I2C	Yes	Yes+	Limitation fix	Identical	Full compatibility for the same feature
TIM	Yes	Yes+	32-bit Counter in TIM2 and TIM5	Identical	Full compatibility for the same feature
DAC	Yes	Yes+	DMA underrun interrupt	Identical	Full compatibility for the same feature
Ethernet	Yes	Yes+	IEEE1588 v2 / Enhanced DMA descriptor	Identical	Full compatibility for the same feature
SDIO	Yes	Yes+	Limitation fix	Identical	Full compatibility for the same feature
USB OTG FS	Yes	Yes+	- Dynamic trimming capability of SOF framing period in Host mode - Embeds a VBUS sensing control	Identical	Full compatibility for the same feature
RTC	Yes	Yes++	New peripheral	Identical for the same feature	Not compatible
ADC	Yes	Yes++	New peripheral	Identical for the same feature	Partial compatibility
FLASH	Yes	Yes++	New peripheral	NA	Not compatible
DMA	Yes	Yes++	New peripheral	NA	Not compatible
GPIO	Yes	Yes++	New peripheral	Identical	Not compatible
CEC	Yes	NA	NA	NA	NA
USB FS Device	Yes	NA	NA	NA	NA
Crypto/hash processor	NA	Yes	NA	NA	NA
RNG	NA	Yes	NA	NA	NA
DCMI	NA	Yes	NA	NA	NA

Table 2. STM32 peripheral compatibility analysis F1 versus F2 series (continued)

Peripheral	F1 series	F2 series	Compatibility		
			Comments	Pinout	SW compatibility
USB OTG HS	NA	Yes	NA	NA	NA
SYSCFG	NA	Yes	NA	NA	NA

Color key:

-  = New feature or new architecture (Yes++)
-  = Same feature, but specification change or enhancement (Yes+)
-  = Feature not available (NA)

3.2 System architecture

STM32 F2 series are a new generation on STM32 with significant improvement in features and performance with outstanding results: 150DMIPS at 120MHz and execution from Flash equivalent to 0-wait state performance.

3.2.1 32-bit multi-AHB bus matrix

The 32-bit multi-AHB bus matrix interconnects all masters (CPU, DMA controllers, Ethernet, USB HS) and slaves (Flash memory, 2 blocks of RAM, FSMC, AHB and APB peripherals) and ensures seamless and efficient operation even when several high-speed peripherals are working simultaneously. For instance, the core can access the Flash through the ART Accelerator and the 112-Kbyte SRAM, while the DMA2 controller is transferring data from the camera interface located on the AHB2 peripheral bus to an LCD connected to the FSMC, and while the USB OTG High Speed interface is storing received data in the 16-Kbyte SRAM block.

Figure 4. STM32 F2 series system architecture

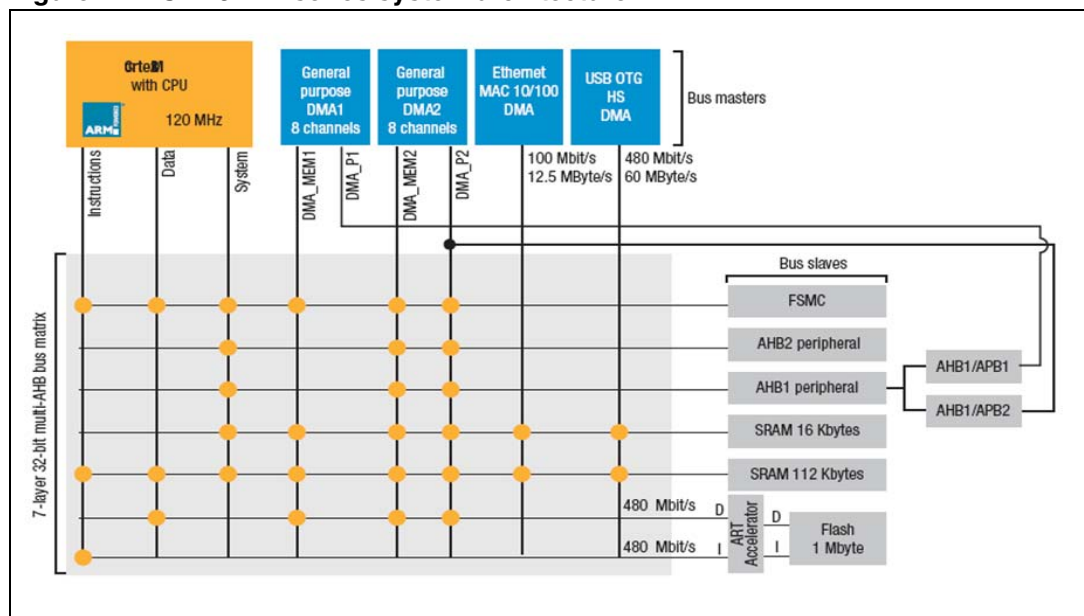

3.2.2 Adaptive real-time memory accelerator (ART Accelerator™)

To free the full performance of the Cortex-M3 core, ST has developed a leading-edge 90 nm process and a unique technology, the adaptive real-time ART Accelerator™. To release the processor full 150 DMIPS performance at this frequency, the accelerator implements an instruction prefetch queue and branch cache which increases program execution speed from the 128-bit Flash memory. Based on the CoreMark benchmark, the performance achieved thanks to the ART accelerator is equivalent to 0 wait state program execution from Flash memory at a CPU frequency up to 120 MHz.

By default (after each device reset) the prefetch queue and branch cache are disabled, the user can enable them using the PRFTEN, ICEN and DCEN bits in the FLASH_ACR register.

3.2.3 Dual SRAM

The 128KB of SRAM is made of 2 blocks; one 112KB and one 16KB. Both can be accessed simultaneously by 2 masters in 0 WS (CPU, DMAs, Ethernet, USB HS).

The 16KB SRAM can be used as a buffer for high speed peripherals like USB-HS, Ethernet, Camera, without impacting the CPU performance.

3.3 Memory mapping

The peripheral address mapping has been changed in the F2 series vs. F1 series, the main change concerns the GPIOs which have been moved to the AHB bus instead of the APB bus to allow them to operate at maximum speed.

The tables below provide the peripheral address mapping correspondence between F2 and F1 series.

Table 3. IP bus mapping differences between STM32 F1 and STM32 F2 series

Peripheral	STM32 F2 series		STM32 F1 series	
	Bus	Base address	Bus	Base address
FSMC Registers	AHB3	0xA0000000	AHB	0xA0000000
RNG	AHB2	0x50060800	NA	NA
HASH		0x50060400	NA	NA
CRYP		0x50060000	NA	NA
DCMI		0x50050000	NA	NA
USB OTG FS		0x50000000	AHB	0x50000000

Table 3. IP bus mapping differences between STM32 F1 and STM32 F2 series



Peripheral	STM32 F2 series		STM32 F1 series	
	Bus	Base address	Bus	Base address
USB OTG HS	AHB1	0x40040000	NA	NA
ETHERNET MAC		0x40028000	AHB	0x40028000
DMA2		0x40026400		0x40020400
DMA1		0x40026000	0x40020000	
BKPSRAM		0x40024000	NA	NA
Flash interface		0x40023C00	AHB	0x40022000
RCC		0x40023800		0x40021000
CRC		0x40023000		0x40023000
GPIO I		0x40022000	NA	NA
GPIO H		0x40021C00	NA	NA
GPIO G		0x40021800	APB2	0x40012000
GPIO F		0x40021400		0x40011C00
GPIO E		0x40021000		0x40011800
GPIO D		0x40020C00		0x40011400
GPIO C		0x40020800		0x40011000
GPIO B		0x40020400		0x40010C00
GPIO A		0x40020000		0x40010800
TIM11		0x40014800		0x40015400
TIM10		APB2	0x40014400	0x40015000
TIM9			0x40014000	0x40014C00
EXTI	0x40013C00		0x40010400	

Table 3. IP bus mapping differences between STM32 F1 and STM32 F2 series

Peripheral	STM32 F2 series		STM32 F1 series	
	Bus	Base address	Bus	Base address
SYSCFG	APB2	0x40013800	NA	NA
SPI1		0x40013000	APB2	0x40013000
SDIO		0x40012C00	AHB	0x40018000
ADC1 - ADC2 - ADC3		0x40012000	APB2	ADC3 - 0x40013C00 ADC2 - 0x40012800 ADC1 - 0x40012400
USART6		0x40011400	NA	NA
USART1		0x40011000	APB2	0x40013800
TIM8		0x40010400		0x40013400
TIM1		0x40010000		0x40012C00
DAC		0x40007400	APB1	0x40007400
PWR		0x40007000		0x40007000
CAN2	0x40006800	0x40006800		
CAN1	0x40006400	0x40006400		
I2C3	0x40005C00	NA	NA	
I2C2	0x40005800	APB1	0x40005800	
I2C1	0x40005400		0x40005400	
UART5	0x40005000		0x40005000	
UART4	0x40004C00		0x40004C00	
USART3	0x40004800		0x40004800	
USART2	0x40004400		0x40004400	
SPI3 / I2S3	0x40003C00		0x40003C00	
SPI2 / I2S2	0x40003800		0x40003800	
IWDG	0x40003000		0x40003000	
WWDG	0x40002C00		APB1	0x40002C00
RTC	0x40002800 (inc. BKP registers)	APB1	0x40002800	
TIM14	0x40002000		0x40002000	
TIM13	0x40001C00		0x40001C00	
TIM12	0x40001800		0x40001800	
TIM7	0x40001400		0x40001400	
TIM6	0x40001000		0x40001000	
TIM5	0x40000C00		0x40000C00	
TIM4	0x40000800		0x40000800	

Table 3. IP bus mapping differences between STM32 F1 and STM32 F2 series

Peripheral	STM32 F2 series		STM32 F1 series	
	Bus	Base address	Bus	Base address
TIM3	APB1	0x40000400	APB1	0x40000400
TIM2		0x40000000		0x40000000
BKP registers	NA	NA		0x40006C00
USB device FS	NA	NA		0x40005C00
AFIO	NA	NA	APB2	0x40001000

Color key:
 = Same feature, but base address change
 = Feature not available (NA)

3.4 RCC

The main differences related to the RCC (Reset and Clock Controller) in the STM32 F2 series vs. STM32 F1 series are presented in the table below.

Table 4. RCC differences between STM32 F1 and STM32 F2 series

RCC main features	STM32 F1 series	STM32 F2 series	Comments
HSI	8 MHz RC factory-trimmed	16 MHz RC factory-trimmed	No change to SW configuration: – Enable/disable RCC_CR[HSION] – Status flag RCC_CR[HSIRDY]
LSI	40 KHz RC	32 KHz RC	No change to SW configuration: – Enable/disable RCC_CSR[LSION] – Status flag RCC_CSR[LSIRDY]
HSE	3 - 25 MHz Depending on the product line used	4 - 26MHz	No change to SW configuration: – Enable/disable RCC_CR[HSEON] – Status flag RCC_CR[HSERDY]
LSE	32.768 KHz	32.768 kHz	No change to SW configuration: – Enable/disable RCC_BDCR[LSEON] – Status flag RCC_BDCR[LSERDY]

Table 4. RCC differences between STM32 F1 and STM32 F2 series

RCC main features	STM32 F1 series	STM32 F2 series	Comments
PLL	<ul style="list-style-type: none"> – <i>Connectivity line</i>: main PLL + 2 PLLs for I2S, Ethernet and OTG FS clock – <i>Other product lines</i>: main PLL 	<ul style="list-style-type: none"> – Main PLL for system, OTG FS, SDIO and RNG clock – Dedicated PLL for I2S clock 	There is no change to PLL enable/disable RCC_CR[PLLON] and status flag RCC_CR[PLLRDY]. However, PLL configuration (clock source selection, multiplication/division factors) are different. In F2 series a dedicated register RCC_PLLCFGR is used to configure the PLL parameters.
System clock source	HSI, HSE or PLL	HSI, HSE or PLL	No change to SW configuration: <ul style="list-style-type: none"> – Selection bits RCC_CFGR[SW] – Status flag RCC_CFGR[SWS]
System clock frequency	up to 72 MHz depending on the product line used 8 MHz after reset using HSI	120 MHz 16 MHz after reset using HSI	For STM32 F2, Flash wait states must be adapted to the system frequency depending on the supply voltage range.
AHB frequency	up to 72 MHz	up to 120 MHz	No change to SW configuration: configuration bits RCC_CFGR[HPRE]
APB1 frequency	up to 36 MHz	up to 30 MHz	No change to SW configuration: configuration bits RCC_CFGR[PPRE1]. In F2 series the PPRE1 bits occupy bits [10:12], instead of bits [8:10] in F1 series.
APB2 frequency	up to 72 MHz	up to 60 MHz	No change to SW configuration: configuration bits RCC_CFGR[PPRE2]. In F2 series the PPRE2 bits occupy bits [13:15] of the register, instead of bits [11:13] in F1 series.
RTC clock source	LSI, LSE or HSE/128	LSI, LSE or HSE clock divided by 2 to 31	RTC clock source configuration is done through the same bits RCC_BDCR[RTCSEL] and RCC_BDCR[RTCEN]. However, in F2 series when HSE is selected as RTC clock source, additional bits are used in CFGFR register, RCC_CFGR[RTCPRE], to select the division factor to be applied on HSE clock.

Table 4. RCC differences between STM32 F1 and STM32 F2 series

RCC main features	STM32 F1 series	STM32 F2 series	Comments
MCO clock source	<ul style="list-style-type: none"> - MCO pin (PA8) - <i>Connectivity Line</i>: HSI, HSE, PLL/2, SYSCLK, PLL2, PLL3 or XT1 - <i>Other product lines</i>: HSI, HSE, PLL/2 or SYSCLK 	<ul style="list-style-type: none"> - <u>MCO1 pin (PA8)</u>: HSI, HSE, LSE or PLL - <u>MCO2 pin (PC9)</u>: PLLI2S, PLL, HSE or SYSCLK - With configurable prescaler, from 1 to 5, for each output. 	<p>MCO configuration in F2 series is different from F1:</p> <ul style="list-style-type: none"> - For MCO1, the prescaler is configured through bits RCC_CFGR[MCO1PRE] and the selection of the clock to output through bits RCC_CFGR[MCO1] - For MCO2, the prescaler is configured through bits RCC_CFGR[MCO2PRE] and the selection of the clock to output through bits RCC_CFGR[MCO2]
Internal oscillator measurement / calibration	<ul style="list-style-type: none"> - LSI connected to TIM5 CH4 IC: can measure LSI w/ respect to HSI/HSE clock 	<ul style="list-style-type: none"> - LSI connected to TIM5 CH4 IC: can measure LSI w/ respect to HSI/HSE clock - LSE connected to TIM5 CH4 IC: can measure HSI w/ respect to LSE clock - HSE connected to TIM11 CH1 IC: can measure HSE range w/ respect to HSI clock 	There is no configuration to perform in RCC registers.
Interrupt	<ul style="list-style-type: none"> - CSS (linked to NMI IRQ) - LSIRDY, LSERDY, HSIRDY, HSERDY, PLLRDY, <u>PLL2RDY</u> and <u>PLL3RDY</u> (linked to RCC global IRQ) 	<ul style="list-style-type: none"> - CSS (linked to IRQ) - LSIRDY, LSERDY, HSIRDY, HSERDY, PLLRDY and <u>PLL2SRDY</u> (linked to RCC global IRQ) 	No change on SW configuration: interrupt enable, disable and pending bits clear are done in RCC_CIR register.

In addition to the differences described in the table above, the following additional steps need to be performed during the migration:

1. System clock configuration: when moving from F1 series to F2 series only a few settings need to be updated in the system clock configuration code; mainly the Flash settings (configure the right wait states for the system frequency, prefetch enable/disable,...) or/and the PLL parameters configuration:
 - a) If the HSE or HSI is used directly as system clock source, in this case only the Flash parameters should be modified.
 - b) If PLL (clocked by HSE or HSI) is used as system clock source, in this case the Flash parameters and PLL configuration need to be updated.

Table 5. below provides an example of porting a system clock configuration from F1 to F2 series:

- STM32F105/7 Connectivity Line running at maximum performance: system clock at 72 MHz (PLL, clocked by the HSE, used as system clock source), Flash with 2 wait states and Flash prefetch queue enabled.
- F2 series running at maximum performance: system clock at 120 MHz (PLL, clocked by the HSE, used as system clock source), Flash with 3 wait states, Flash prefetch queue and branch cache enabled.

As shown in the table below, only the Flash settings and PLL parameters (code in ***Bold Italic***) need to be rewritten to run on F2 series. However, HSE, AHB prescaler and system clock source configuration are left unchanged, and the APB's prescalers are adapted to the maximum APB frequency in the F2 series.

- Note:*
- 1 *The source code presented in the table below is intentionally simplified (time-out in wait loop removed) and is based on the assumption that the RCC and Flash registers are at their reset values.*
 - 2 *For STM32F2xx you can use the clock configuration tool, STM32F2xx_Clock_Configuration.xls, to generate a customized system_stm32f2xx.c file containing a system clock configuration routine, that you adapt to your application requirements. For more information, refer to AN3362 "Clock configuration tool for STM32F2xx microcontrollers"*

Table 5. Example of migrating system clock configuration code from F1 to F2 series

STM32F105/7 running at 72 MHz (PLL as clock source) with 2 wait state	STM32F2xx running at 120 MHz (PLL as clock source) with 3 wait state
<pre> /* Enable HSE -----*/ RCC->CR = ((uint32_t)RCC_CR_HSEON); /* Wait till HSE is ready */ while((RCC->CR & RCC_CR_HSERDY) == 0) { } /* Flash configuration -----*/ /* Prefetch ON, Flash 2 wait state */ FLASH->ACR = FLASH_ACR_PRFTBE FLASH_ACR_LATENCY_2; /* AHB and APBs prescaler configuration --*/ /* HCLK = SYSCLK */ RCC->CFGR = RCC_CFGR_HPRE_DIV1; /* PCLK2 = HCLK */ RCC->CFGR = RCC_CFGR_PPRE2_DIV1; /* PCLK1 = HCLK */ RCC->CFGR = RCC_CFGR_PPRE1_DIV2; /* PLLs configuration -----*/ /* PLL2CLK = (HSE / 5) * 8 = 40 MHz PREDIV1CLK = PLL2 / 5 = 8 MHz */ RCC->CFGR2 = RCC_CFGR2_PREDIV2_DIV5 RCC_CFGR2_PLL2MUL8 RCC_CFGR2_PREDIV1SRC_PLL2 RCC_CFGR2_PREDIV1_DIV5; /* Enable PLL2 */ RCC->CR = RCC_CR_PLL2ON; /* Wait till PLL2 is ready */ while((RCC->CR & RCC_CR_PLL2RDY) == 0) { } /* PLLCLK = PREDIV1 * 9 = 72 MHz */ RCC->CFGR = RCC_CFGR_PLLXTPRE_PREDIV1 RCC_CFGR_PLLSRC_PREDIV1 RCC_CFGR_PLLMULL9; /* Enable the main PLL */ RCC->CR = RCC_CR_PLLON; /* Wait till the main PLL is ready */ while((RCC->CR & RCC_CR_PLLRDY) == 0) { } /* Main PLL used as system clock source --*/ RCC->CFGR = RCC_CFGR_SW_PLL; /* Wait till the main PLL is used as system clock source */ while ((RCC->CFGR & RCC_CFGR_SWS) != RCC_CFGR_SWS_PLL) { } </pre>	<pre> /* Enable HSE -----*/ RCC->CR = ((uint32_t)RCC_CR_HSEON); /* Wait till HSE is ready */ while((RCC->CR & RCC_CR_HSERDY) == 0) { } /* Flash configuration -----*/ /* Flash prefetch and cache ON, Flash 3 wait state */ FLASH->ACR = FLASH_ACR_PRFTEN FLASH_ACR_ICEN FLASH_ACR_DCEN FLASH_ACR_LATENCY_3WS; /* AHB and APBs prescaler configuration --*/ /* HCLK = SYSCLK */ RCC->CFGR = RCC_CFGR_HPRE_DIV1; /* PCLK2 = HCLK / 2 */ RCC->CFGR = RCC_CFGR_PPRE2_DIV2; /* PCLK1 = HCLK / 4 */ RCC->CFGR = RCC_CFGR_PPRE1_DIV4; /* PLL configuration -----*/ /* PLLCLK = ((HSE / PLL_M) * PLL_N) / PLL_P = ((25 MHz / 25) * 240) / 2 = 120 MHz */ RCC->PLLCFGR = PLL_M (PLL_N << 6) (((PLL_P >> 1) - 1) << 16) (RCC_PLLCFGR_PLLSRC_HSE) (PLL_Q << 24); /* Enable the main PLL */ RCC->CR = RCC_CR_PLLON; /* Wait till the main PLL is ready */ while((RCC->CR & RCC_CR_PLLRDY) == 0) { } /* Main PLL used as system clock source --*/ RCC->CFGR = RCC_CFGR_SW_PLL; /* Wait till the main PLL is used as system clock source */ while ((RCC->CFGR & RCC_CFGR_SWS) != RCC_CFGR_SWS_PLL) { } </pre>

2. **Peripheral access configuration:** The address mapping of some peripherals has been changed in F2 series vs. F1 series, so you need to use different registers to [enable/disable] or [enter/exit] the peripheral [clock] or [from reset mode].

Table 6. RCC registers used for peripheral access configuration

Bus	Register	Comments
AHB1	RCC_AHB1RSTR	Used to [enter/exit] the AHB1 peripheral from reset
	RCC_AHB1ENR	Used to [enable/disable] the AHB1 peripheral clock
	RCC_AHB1LPENR	Used to [enable/disable] the AHB1 peripheral clock in low power Sleep mode
AHB2	RCC_AHB2RSTR	Used to [enter/exit] the AHB2 peripheral from reset
	RCC_AHB2ENR	Used to [enable/disable] the AHB2 peripheral clock
	RCC_AHB2LPENR	Used to [enable/disable] the AHB2 peripheral clock in low power Sleep mode
AHB3	RCC_AHB3RSTR	Used to [enter/exit] the AHB3 peripheral from reset
	RCC_AHB3ENR	Used to [enable/disable] the AHB3 peripheral clock
	RCC_AHB3LPENR	Used to [enable/disable] the AHB3 peripheral clock in low power Sleep mode
APB1	RCC_APB1RSTR	Used to [enter/exit] the APB1 peripheral from reset
	RCC_APB1ENR	Used to [enable/disable] the APB1 peripheral clock
	RCC_APB1LPENR	Used to [enable/disable] the APB1 peripheral clock in low power Sleep mode
APB2	RCC_APB2RSTR	Used to [enter/exit] the APB2 peripheral from reset
	RCC_APB2ENR	Used to [enable/disable] the APB2 peripheral clock
	RCC_APB2LPENR	Used to [enable/disable] the APB2 peripheral clock in low power Sleep mode

To configure the access to a given peripheral you have first to know to which bus this peripheral is connected, refer to [Table 3 on page 13](#), then depending on the action needed you have to program the right register as described in [Table 6](#). above. For example, USART1 is connected to APB2 bus, to enable the USART1 clock you have to configure the APB2ENR register as follows:

```
RCC->APB2ENR |= RCC_APB2ENR_USART1EN;
```

to disable USART1 clock during Sleep mode (to reduce power consumption) you have to configure APB2LPENR register as follows:

```
RCC->APB2LPENR |= RCC_APB2LPENR_USART1LPEN;
```

3. **Peripheral clock configuration:** some peripherals have a dedicated clock source independent from the system clock, and used to generate the clock required for their operation::
 - a) **I2S:** in the F2 series the I2S clock can be derived either from a specific PLL (PLLI2S) or from an external clock mapped on the I2S_CKIN pin:

To use PLLI2S as I2S clock source: set RCC_CFGR[I2SSRC] bit to 1, configure the PLLI2S parameters (using RCC_PLLI2SCFGR[PLLI2SR] and RCC_PLLI2SCFGR[PLLI2SN] bits) then enable it (set RCC_CR[PLLI2SON] bit to

1), finally enable the I2S clock (using `RCC_APB1ENR[SPI2EN]` or/and `RCC_APB1ENR[SPI3EN]` bits)

To use external clock as I2S clock source: set `RCC_CFGR[I2SSRC]` bit to 0, then enable the I2S clock (using `RCC_APB1ENR[SPI2EN]` or/and `RCC_APB1ENR[SPI3EN]` bits)

- b) **USB OTG FS and SDIO:** in the F2 series the USB OTG FS requires a frequency of 48 MHz to work correctly, while the SDIO requires a frequency less than or equal to 48 MHz to work correctly. This clock is derived from the PLL through the Q divider.
- c) **ADC:** in the F2 series the ADC features two clock schemes:
 - Clock for the analog circuitry:** `ADCCLK`, common to all ADCs. This clock is generated from the `APB2` clock divided by a programmable prescaler that allows the ADC to work at $f_{PCLK2}/2, /4, /6$ or $/8$. The maximum value of `ADCCLK` is 30 MHz when the `APB2` clock is at 60 MHz. This configuration is done using `ADC_CCR[ADCPRE]` bits.
 - Clock for the digital interface (used for register read/write access):** This clock is equal to the `APB2` clock. The digital interface clock can be enabled/disabled individually for each ADC through the `RCC_APB2ENR` register (`ADC1EN`, `ADC2EN` and `ADC3EN` bits). However, there is only a single bit (`RCC_APB2RSTR[ADCRST]`) to reset the three ADCs at the same time.

3.5 DMA

STM32 F2 series features a new DMA controller specially designed to get optimum system bandwidth, based on a complex bus matrix architecture. Thus the architecture, features and registers of this controller are different from the DMA embedded in the F1 series, i.e. any code on F1series using the DMA needs to be rewritten to run on F2 series.

STM32 F1 series embeds two DMA controllers, each controller has up to 7 channels. Each channel is dedicated to managing memory access requests from one or more peripherals. It has an arbiter for handling the priority between DMA requests.

STM32 F2 series embeds two DMA controllers, each controller has 8 streams, each stream is dedicated to managing memory access requests from one or more peripherals. Each stream can have up to 8 channels (requests) in total. Each has an arbiter for handling the priority between DMA requests.

The table below presents the correspondence between peripheral's DMA requests in STM32 F1 series and STM32 F2 series.

For more information about STM32 F2's DMA configuration and usage, please refer to section "Stream configuration procedure" in DMA chapter of STM32F2xx Reference Manual (RM0033).

Table 7. DMA request differences between STM32 F1 series and STM32 F2 series

Peripheral	DMA request	STM32 F1series	STM32 F2 series
ADC1	ADC1	DMA1_Channel1	DMA2_Channel0: stream0 / stream4
ADC2	ADC2	NA	DMA2_Channel1: stream2 / stream3
ADC3	ADC3	DMA2_Channel5	DMA2_Channel2: stream0 / stream1
DAC	DAC_Channel1 DAC_Channel2	DMA2_Channel3 / DMA1_Channel3 ⁽¹⁾ DMA2_Channel4 / DMA1_Channel4 ⁽¹⁾	DMA1_Channel7: stream5 DMA1_Channel7: stream6
SPI1	SPI1_Rx SPI1_Tx	DMA1_Channel2 DMA1_Channel3	DMA2_Channel3: stream0 / stream2 DMA2_Channel3: stream3 / stream5
SPI2	SPI2_Rx SPI2_Tx	DMA1_Channel4 DMA1_Channel5	DMA1_Channel0: stream3 DMA1_Channel0: stream4
SPI3	SPI3_Rx SPI3_Tx	DMA2_Channel1 DMA2_Channel2	DMA1_Channel0: stream0 / stream2 DMA1_Channel0: stream5 / stream7
USART1	USART1_Rx USART1_Tx	DMA1_Channel5 DMA1_Channel4	DMA2_Channel4: stream2 / stream5 DMA2_Channel4: stream7
USART2	USART2_Rx USART2_Tx	DMA1_Channel6 DMA1_Channel7	DMA1_Channel4: stream5 DMA1_Channel4: stream6
USART3	USART3_Rx USART3_Tx	DMA1_Channel3 DMA1_Channel2	DMA1_Channel4: stream1 DMA1_Channel4: stream3 / DMA1_Channel7: stream4
USART6	USART6_Rx USART6_Tx	NA	DMA2_Channel5: stream1 / stream2 DMA2_Channel5: stream6 / stream7

Table 7. DMA request differences between STM32 F1 series and STM32 F2 series (continued)

Peripheral	DMA request	STM32 F1series	STM32 F2 series
UART4	UART4_Rx	DMA2_Channel3	DMA1_Channel4: stream2
	UART4_Tx	DMA2_Channel5	DMA1_Channel4: stream4
UART5	UART5_Rx	DMA2_Channe4	DMA1_Channel4: stream0
	UART5_Tx	DMA2_Channel1	DMA1_Channel4: stream7
I2C1	I2C1_Rx	DMA1_Channe7	DMA1_Channel1: stream0 / stream5
	I2C1_Tx	DMA1_Channel6	DMA1_Channel1: stream6 / stream7
I2C2	I2C2_Rx	DMA1_Channel5	DMA1_Channel7: stream2 / stream3
	I2C2_Tx	DMA1_Channel4	DMA1_Channel7: stream7
I2C3	I2C3_Rx	NA	DMA1_Channel3: stream2
	I2C3_Tx		DMA1_Channel3: stream4
SDIO	SDIO	DMA2_Channel4	DMA2_Channel4: stream3 / stream6
TIM1	TIM1_UP	DMA1_Channel5	DMA2_Channel6: stream5
	TIM1_CH1	DMA1_Channel2	DMA2_Channel0: stream6 / DMA2_Channel6: stream1 / stream3
	TIM1_CH2	DMA1_Channel3	DMA2_Channel0: stream6 / DMA2_Channel6: stream2
	TIM1_CH3	DMA1_Channel6	DMA2_Channel0: stream6 / DMA2_Channel6: stream6
	TIM1_CH4	DMA1_Channel4	DMA2_Channel6: stream4
	TIM1_TRIG	DMA1_Channel4	DMA2_Channel6: stream0 / stream4
	TIM1_COM	DMA1_Channel4	DMA2_Channel6: stream4
TIM8	TIM8_UP	DMA2_Channel1	DMA2_Channel7: stream1
	TIM8_CH1	DMA2_Channel3	DMA2_Channel0: stream2 / DMA2_Channel7: stream2
	TIM8_CH2	DMA2_Channel5	DMA2_Channel0: stream2 / DMA2_Channel7: stream3
	TIM8_CH3	DMA2_Channel1	DMA2_Channel0: stream2 / DMA2_Channel7: stream4
	TIM8_CH4	DMA2_Channel2	DMA2_Channel7: stream7
	TIM8_TRIG	DMA2_Channel2	DMA2_Channel7: stream7
	TIM8_COM	DMA2_Channel2	DMA2_Channel7: stream7
TIM2	TIM2_UP	DMA1_Channel2	DMA1_Channel3: stream1 / stream7
	TIM2_CH1	DMA1_Channel5	DMA1_Channel3: stream5
	TIM2_CH2	DMA1_Channel7	DMA1_Channel3: stream6
	TIM2_CH3	DMA1_Channel1	DMA1_Channel3: stream1
	TIM2_CH4	DMA1_Channel7	DMA1_Channel3: stream6 / stream7
TIM3	TIM3_UP	DMA1_Channel3	DMA1_Channel5: stream2
	TIM3_CH1	DMA1_Channel6	DMA1_Channel5: stream4
	TIM3_TRIG	DMA1_Channel6	DMA1_Channel5: stream4
	TIM3_CH3	DMA1_Channel2	DMA1_Channel5: stream7
	TIM3_CH4	DMA1_Channel3	DMA1_Channel5: stream2
	TIM3_CH2	NA	DMA1_Channel5: stream5

Table 7. DMA request differences between STM32 F1 series and STM32 F2 series (continued)

Peripheral	DMA request	STM32 F1series	STM32 F2 series
TIM4	TIM4_UP	DMA1_Channel7	DMA1_Channel2: stream6
	TIM4_CH1	DMA1_Channel1	DMA1_Channel2: stream0
	TIM4_CH2	DMA1_Channel4	DMA1_Channel2: stream3
	TIM4_CH3	DMA1_Channel5	DMA1_Channel2: stream7
TIM5	TIM5_UP	DMA2_Channel2	DMA1_Channel6: stream0 / stream6
	TIM5_CH1	DMA2_Channel5	DMA1_Channel6: stream2
	TIM5_CH2	DMA2_Channel4	DMA1_Channel6: stream4
	TIM5_CH3	DMA2_Channel2	DMA1_Channel6: stream0
	TIM5_CH4	DMA2_Channel1	DMA1_Channel6: stream1 / stream3
	TIM5_TRIG	DMA2_Channel1	DMA1_Channel6: stream1 / stream3
TIM6	TIM6_UP	DMA2_Channel3 / DMA1_Channel3 ⁽¹⁾	DMA1_Channel7: stream1
TIM7	TIM7_UP	DMA2_Channel4 / DMA1_Channel4 ⁽¹⁾	DMA1_Channel1: stream2 / stream4
TIM15	TIM15_UP	DMA1_Channel5	NA
	TIM15_CH1	DMA1_Channel5	
	TIM15_TRIG	DMA1_Channel5	
	TIM15_COM	DMA1_Channel5	
TIM16	TIM16_UP	DMA1_Channel6	NA
	TIM16_CH1	DMA1_Channel6	
TIM17	TIM17_UP	DMA1_Channel7	NA
	TIM17_CH1	DMA1_Channel7	
DCMI	DCMI	NA	DMA2_Channel1: stream1 / stream7
CRYP	CRYP_OUT	NA	DMA2_Channel2: stream5
	CRYP_IN		DMA2_Channel2: stream6
	HASH_IN		DMA2_Channel2: stream7

1. For High-density value line devices, the DAC DMA requests are mapped respectively on DMA1 Channel 3 and DMA1 Channel 4

3.5.1 Interrupts

The table below presents the interrupt vectors in STM32 F2 series vs. F1 series

The changes in F2 interrupt vectors impact only a few peripherals:

1. **ADC:** in F1 series there are two interrupt vectors for the ADCs; ADC1_2 and ADC3. However in F2 series there is a single interrupt vector for all ADCs; ADC_IRQ. As consequence, when moving to F2 series you have to add some code in the ADC IRQ handler to know which ADC has generated the Interrupt.
2. **DMA:** in F2 series you have to check first to which DMA stream the peripheral DMA request is connected, then in the associated DMA stream IRQ add the code needed to manage the DMA interrupt request (in F2 series there are five interrupt request sources, while there are only three in F1 series).
 - Let's consider the following example; an application uses the DMA to transfer data from memory to the I2S2 data out register and at each end of DMA transfer, an interrupt is generated to reconfigure the I2S/DMA parameters. In F1 series the I2S2 DMA request is configured to be served by DMA1_Channel4, so the code used to manage DMA end of transfer is put in the DMA1_Channel4 IRQ handler. In F2 series the I2S2 DMA request is configured to be served by DMA1_Stream3_Channel0, so the code used to manage DMA end of transfer is put in the in DMA1_Stream3 IRQ handler.
3. **TIM6:** in F2 series the TIM6 interrupt vector is shared with the DAC interrupt, so when TIM6 and DAC interrupts are used in the same application you have to add some code to check which peripheral has generated the interrupt.

Table 8. Interrupt vector differences between STM32 F1 series and STM32 F2 series

Position	STM32 F1 series	STM32 F2 series
0	WWDG	WWDG
1	PVD	PVD
2	TAMPER	TAMP_STAMP
3	RTC	RTC_WKUP
4	FLASH	FLASH
5	RCC	RCC
6	EXTI0	EXTI0
7	EXTI1	EXTI1
8	EXTI2	EXTI2
9	EXTI3	EXTI3
10	EXTI4	EXTI4
11	DMA1_Channel1	DMA1_Stream0
12	DMA1_Channel2	DMA1_Stream1
13	DMA1_Channel3	DMA1_Stream2
14	DMA1_Channel4	DMA1_Stream3
15	DMA1_Channel5	DMA1_Stream4
16	DMA1_Channel6	DMA1_Stream5
17	DMA1_Channel7	DMA1_Stream6
18	ADC1_2	ADC
19	CAN1_TX / USB_HP_CAN_TX ⁽¹⁾	CAN1_TX
20	CAN1_RX0 / USB_LP_CAN_RX0 ⁽¹⁾	CAN1_RX0
21	CAN1_RX1	CAN1_RX1
22	CAN1_SCE	CAN1_SCE
23	EXTI9_5	EXTI9_5
24	TIM1_BRK / TIM1_BRK_TIM9 ⁽¹⁾	TIM1_BRK_TIM9
25	TIM1_UP / TIM1_UP_TIM10 ⁽¹⁾	TIM1_UP_TIM10
26	TIM1_TRG_COM / TIM1_TRG_COM_TIM11 ⁽¹⁾	TIM1_TRG_COM_TIM11
27	TIM1_CC	TIM1_CC
28	TIM2	TIM2
29	TIM3	TIM3
30	TIM4	TIM4
31	I2C1_EV	I2C1_EV
32	I2C1_ER	I2C1_ER
33	I2C2_EV	I2C2_EV



Table 8. Interrupt vector differences between STM32 F1 series and STM32 F2 series

Position	STM32 F1 series	STM32 F2 series
34	I2C2_ER	I2C2_ER
35	SPI1	SPI1
36	SPI2	SPI2
37	USART1	USART1
38	USART2	USART2
39	USART3	USART3
40	EXTI15_10	EXTI15_10
41	RTC_Alarm	RTC_Alarm
42	OTG_FS_WKUP / USBWakeUp	OTG_FS_WKUP
43	TIM8_BRK / TIM8_BRK_TIM12 ⁽¹⁾	TIM8_BRK_TIM12
44	TIM8_UP / TIM8_UP_TIM13 ⁽¹⁾	TIM8_UP_TIM13
45	TIM8_TRG_COM / TIM8_TRG_COM_TIM14 ⁽¹⁾	TIM8_TRG_COM_TIM14
46	TIM8_CC	TIM8_CC
47	ADC3	DMA1_Stream7
48	FSMC	FSMC
49	SDIO	SDIO
50	TIM5	TIM5
51	SPI3	SPI3
52	UART4	UART4
53	UART5	UART5
54	TIM6 / TIM6_DAC ⁽¹⁾	TIM6_DAC
55	TIM7	TIM7
56	DMA2_Channel1	DMA2_Stream0
57	DMA2_Channel2	DMA2_Stream1
58	DMA2_Channel3	DMA2_Stream2
59	DMA2_Channel4 / DMA2_Channel4_5 ⁽¹⁾	DMA2_Stream3
60	DMA2_Channel5	DMA2_Stream4
61	ETH	ETH
62	ETH_WKUP	ETH_WKUP
63	CAN2_TX	CAN2_TX
64	CAN2_RX0	CAN2_RX0
65	CAN2_RX1	CAN2_RX1
66	CAN2_SCE	CAN2_SCE
67	OTG_FS	OTG_FS

Table 8. Interrupt vector differences between STM32 F1 series and STM32 F2 series

Position	STM32 F1 series	STM32 F2 series
68	NA	DMA2_Stream5
69	NA	DMA2_Stream6
70	NA	DMA2_Stream7
71	NA	USART6
72	NA	I2C3_EV
73	NA	I2C3_ER
74	NA	OTG_HS_EP1_OUT
75	NA	OTG_HS_EP1_IN
76	NA	OTG_HS_WKUP
77	NA	OTG_HS
78	NA	DCMI
79	NA	CRYP
80	NA	HASH_RNG

Color key:

-  = Different Interrupt vector
-  = Interrupt Vector name changed but F1 peripheral still mapped on the same Interrupt Vector position in F2 series
-  = Feature not available (NA)

1. Depending on the product line used

3.6 GPIO

The STM32 F2 GPIO peripheral embeds new features compared to F1 series, the main ones are listed below:

- GPIO mapped on AHB bus for better performance
- I/O pin multiplexer and mapping: pins are connected to on-board peripherals/modules through a multiplexer that allows only one peripheral alternate function (AF) to be connected to an I/O pin at a time. In this way, there can be no conflict between peripherals sharing the same I/O pin.
- More possibilities and features for I/O configuration

The F2 GPIO peripheral is a new design and thus the architecture, features and registers are different from the GPIO peripheral in the F1 series, i.e. any code on F1 series using the GPIO needs to be rewritten to run on F2 series.

For more information about STM32 F2's GPIO programming and usage, please refer to section "I/O pin multiplexer and mapping" in the GPIO chapter of STM32F2xx Reference Manual (RM0033).

The table below presents the differences between GPIOs in the STM32 F1 series and STM32 F2 series.

Table 9. GPIO differences between STM32 F1 series and STM32 F2 series

GPIO	STM32 F1 series	STM32 F2 series
Input mode	Floating PU PD	Floating PU PD
General purpose output	PP OD	PP PP + PU PP + PD OD OD + PU OD + PD
Alternate Function output	PP OD	PP PP + PU PP + PD OD OD + PU OD + PD
Input / Output	Analog	Analog
Output speed	2 MHz 10 MHz 50 MHz	2 MHz 25 MHz 50 MHz 100 MHz
Alternate function selection	To optimize the number of peripheral I/O functions for different device packages, it is possible to remap some alternate functions to some other pins (software remap).	Highly flexible pin multiplexing allows no conflict between peripherals sharing the same I/O pin.
Max IO toggle frequency	16 MHz	60 MHz

3.6.1 Alternate function mode

In STM32 F1 series

1. The configuration to use an I/O as alternate function depends on the peripheral mode used. For example, the USART Tx pin should be configured as alternate function push-pull while USART Rx pin should be configured as input floating or input pull-up.
2. To optimize the number of peripheral I/O functions for different device packages (especially with those with low pin count), it is possible by software to remap some alternate functions to other pins. For example, the USART2_RX pin can be mapped on PA3 (default remap) or PD6 (done through software remap) pin.

In STM32 F2 series

1. Whatever the peripheral mode used, the I/O must be configured as alternate function, then the system can use the I/O in the proper way (input or output).
2. The I/O pins are connected to onboard peripherals/modules through a multiplexer that allows only one peripheral's alternate function to be connected to an I/O pin at a time.

In this way, there can be no conflict between peripherals sharing the same I/O pin. Each I/O pin has a multiplexer with sixteen alternate function inputs (AF0 to AF15) that can be configured through the GPIOx_AFRL and GPIOx_AFRH registers:

- After reset all I/Os are connected to the system's alternate function 0 (AF0)
 - The peripherals' alternate functions are mapped from AF1 to AF13
 - Cortex-M3 EVENTOUT is mapped on AF15
3. In addition to this flexible I/O multiplexing architecture, each peripheral has alternate functions mapped onto different I/O pins to optimize the number of peripheral I/O functions for different device packages. For example, the USART2_RX pin can be mapped on PA3 or PD6 pin

Note: Please refer to the "Alternate function mapping" table in the STM32F20x and STM32F21x datasheets for the detailed mapping of the system and peripherals' alternate function I/O pins.

4. Configuration procedure
- Configure the desired I/O as an alternate function in the GPIOx_MODER register
 - Select the type, pull-up/pull-down and output speed via the GPIOx_OTYPER, GPIOx_PUPDR and GPIOx_OSPEEDER registers, respectively
 - Connect the I/O to the desired AFx in the GPIOx_AFRL or GPIOx_AFRH register

3.7 EXTI source selection

In STM32 F1 the selection of the EXTI line source is performed through the EXTIx bits in the AFIO_EXTICRx registers, while in F2 series this selection is done through the EXTIx bits in the SYSCFG_EXTICRx registers.

Only the mapping of the EXTICRx registers has been changed, without any changes to the meaning of the EXTIx bits. However, the range of EXTIx bits values has been extended to 0b1000 to support the two ports added in F2, port H and I (in F1 series the maximum value is 0b0110).

3.8 FLASH

The table below presents the difference between the FLASH interface in the STM32 F1 and STM32 F2 series, these differences are the following:

- New interface, new technology
- New architecture, sectors instead of pages
- New read protection mechanism, 3 read protection levels with JTAG fuse



As consequence the F2 Flash programming procedures and registers are different from the the F1 series, i.e. any code on F1 series using the Flash needs to be rewritten to run on F2 series.

For more information on programming, erasing and protection of the F2 Flash memory, please refer to the STM32F2xx Flash programming manual (PM0059).

Table 10. FLASH differences between STM32 F1 series and STM32 F2 series

Flash		STM32 F1 series	STM32 F2 series
Wait States		up to 2	up to 7 (depending on the supply voltage)
Main/Program memory	Start Address	0x0800 0000	0x0800 0000
	End Address	up to 0x080F FFFF	up to 0x080F FFFF
	Granularity	Page of 2 Kbytes size except for Low and Medium density Page of 1 Kbytes	4 sectors of 16 Kbytes 1 sector of 64 Kbytes 7 sectors of 128 Kbytes
EEPROM memory	Start Address	Available by SW emulation ⁽¹⁾	Available by SW emulation ⁽²⁾
	End Address		
System memory	Start Address	0x1FFF F000	0x1FFF 0000
	End Address	0x1FFF F7FF	0x1FFF 77FF
Option Bytes	Start Address	0x1FFF F800	0x1FFF C000
	End Address	0x1FFF F80F	0x1FFF C007
OTP	Start Address	NA	0x1FFF 7800
	End Address		0x1FFF 79FF
Flash interface	Start address	0x4002 2000	0x4002 3C00
	Programming procedure	Same for all product lines	Different from F1 series
Erase granularity		Page (1 or 2 Kbytes)	Sector
Program mode		Half word	Byte Half word word Double word (with external VPP supply)
Read Protection	Unprotection	Read protection disable RDP = 0xA55A	Level 0 no protection RDP = 0xAA
	Protection	Read protection enable RDP != 0xA55A	Level 1 memory protection RDP != (Level 2 & Level 0)
	JTAG fuse	NA	Level 2 RDP = 0xCC ⁽³⁾
Write protection		Protection by 4Kbytes	Protection by sector

Table 10. FLASH differences between STM32 F1 series and STM32 F2 series

Flash	STM32 F1 series	STM32 F2 series
User Option bytes	STOP	STOP
	STANDBY	STANDBY
	WDG	WDG
	NA	BOR level
Color key:  = New feature or new architecture  = Same feature, but specification change or enhancement  = Feature not available (NA)		

1. For more details refer to Application note AN2594 *EEPROM emulation in STM32F10x microcontrollers*
2. For more details refer to Application note AN3390 *EEPROM emulation in STM32F2xx microcontrollers*
3. Memory read protection Level 2 is an irreversible operation. When Level 2 is activated, the level of protection cannot be decreased to Level 0 or Level 1.

3.9 ADC

The table below presents the differences between the ADC interface of STM32 F1 series and STM32 F2 series, these differences are the following:

- New digital interface
- New architecture and new features

Table 11. ADC differences between STM32 F1 series and STM32 F2 series

ADC	STM32 F1 series	STM32 F2 series
ADC Type	SAR structure	SAR structure
Instances	ADC1 / ADC2 / ADC3	ADC1 / ADC2 / ADC3
Max Sampling freq	1 MSPS	2 MSPS
Number of channels	up to 21 channels	up to 24 Channels
Resolution	12-bit	12-bit, 10-bit, 8-bit, 6-bit
Conversion Modes	Single / continuous / Scan / Discontinuous / Dual Mode	Single / continuous / Scan / Discontinuous / Dual Mode / Triple Mode
DMA	Yes	Yes

Table 11. ADC differences between STM32 F1 series and STM32 F2 series (continued)

ADC	STM32 F1 series		STM32 F2 series	
External trigger	Yes		Yes	
	<u>External event for regular group</u> For ADC1 and ADC2: TIM1 CC1 TIM1 CC2 TIM1 CC3 TIM2 CC2 TIM3 TRGO TIM4 CC4 EXTI line 11 / TIM8_TRGO For ADC3: TIM3 CC1 TIM2 CC3 TIM1 CC3 TIM8 CC1 TIM8 TRGO TIM5 CC1 TIM5 CC3	<u>External event for injected group</u> For ADC1 and ADC2: TIM1 TRGO TIM1 CC4 TIM2 TRGO TIM2 CC1 TIM3 CC4 TIM4 TRGO EXTI line15 / TIM8_CC4 For ADC3: TIM1 TRGO TIM1 CC4 TIM4 CC3 TIM8 CC2 TIM8 CC4 TIM5 TRGO TIM5 CC4	<u>External event for regular group</u> TIM1 CC1 TIM1 CC2 TIM1 CC3 TIM2 CC2 TIM2 CC3 TIM2 CC4 TIM2 TRGO TIM3 CC1 TIM3 TRGO TIM4 CC4 TIM5 CC1 TIM5 CC2 TIM5 CC3 TIM8 CC1 TIM8 TRGO EXTI line11	<u>External event for injected group</u> TIM1 CC4 TIM1 TRGO TIM2 CC1 TIM2 TRGO TIM3 CC2 TIM3 CC4 TIM4 CC1 TIM4 CC2 TIM4 CC3 TIM4 TRGO TIM5 CC4 TIM5 TRGO TIM8 CC2 TIM8 CC3 TIM8 CC4 EXTI line15
Supply requirement	2.4 V to 3.6 V		2.4 V to 3.6 V for full speed 1.8 V to 3.6 V for reduced speed	
Input range	$V_{REF-} \leq V_{IN} \leq V_{REF+}$		$V_{REF-} \leq V_{IN} \leq V_{REF+}$	
<p>Color key:</p> <p> = Same feature, but specification change or enhancement</p>				



3.10 PWR

In STM32 F2 series the PWR controller presents some differences vs. F1 series, these differences are summarized in the table below. However, the programming interface is unchanged.

Table 12. PWR differences between STM32 F1 series and STM32 F2 series

PWR	STM32 F1 series	STM32 F2 series
Power supplies	<p>1. VDD = 2.0 to 3.6 V: external power supply for I/Os and the internal regulator. Provided externally through VDD pins.</p> <p>2. VSSA, VDDA = 2.0 to 3.6 V: external analog power supplies for ADC, DAC, Reset blocks, RCs and PLL (minimum voltage to be applied to VDDA is 2.4 V when the ADC or DAC is used). VDDA and VSSA must be connected to VDD and VSS, respectively.</p> <p>3. VBAT = 1.8 to 3.6 V: power supply for RTC, external clock 32 kHz oscillator and backup registers (through power switch) when VDD is not present.</p>	<p>1. VDD = 1.8 to 3.6 V: external power supply for I/Os and the internal regulator (when enabled), provided externally through VDD pins. On WLCSP package, VDD ranges from 1.65 to 3.6 V. VDD/VDDA minimum value of 1.65 V is obtained when the device operates in a reduced temperature range.</p> <p>2. VSSA, VDDA = 1.8 to 3.6 V: external analog power supplies for ADC, DAC, Reset blocks, RCs and PLL. VDDA and VSSA must be connected to VDD and VSS, respectively.</p> <p>3. VBAT = 1.65 to 3.6 V: power supply for RTC, external clock 32 kHz oscillator and backup registers (through power switch) when VDD is not present.</p>
	NA	Note: in UFBGA and WLCSP packages, the internal regulator can be switched off
Battery backup domain	<ul style="list-style-type: none"> – Backup registers – RTC – LSE – PC13 to PC15 I/Os <p>Note: in F1 series the Backup registers are integrated in the BKP peripheral.</p>	<ul style="list-style-type: none"> – RTC with backup registers – LSE – PC13 to PC15 I/Os, plus PI8 I/O (when available) <p>Note: in F2 series the backup registers are integrated in the RTC peripheral</p>
	NA	4 Kbytes backup SRAM when the low power backup regulator is enabled (this SRAM can be used as EEPROM as long as the VBAT supply is present)
Power supply supervisor	Integrated POR / PDR circuitry Programmable Voltage Detector (PVD)	Integrated POR / PDR circuitry Programmable voltage detector (PVD)
	NA	Brownout reset (BOR)
Low-power modes	<ul style="list-style-type: none"> Sleep mode Stop mode Standby mode (1.8V domain powered-off) 	<ul style="list-style-type: none"> Sleep mode + peripherals automatic clock gating(*) Stop mode Standby mode (1.2 V domain powered off) <p>(*)To further reduce power consumption in Sleep mode the peripheral clocks can be disabled prior to executing the WFI or WFE instructions.</p>

Table 12. PWR differences between STM32 F1 series and STM32 F2 series

PWR	STM32 F1 series	STM32 F2 series
Wake-up sources	Sleep mode: – Any peripheral interrupt/wakeup event Stop mode: – Any EXTI line event/interrupt Standby mode: – WKUP pin rising edge – RTC alarm – External reset in NRST pin – IWDG reset	Sleep mode: – Any peripheral interrupt/wakeup event Stop mode: – Any EXTI line event/interrupt Standby mode: – WKUP pin rising edge – RTC alarm A, RTC alarm B, RTC Wakeup, Tamper event, TimeStamp event – External reset in NRST pin – IWDG reset
Configuration	NA	In F2 two additional bits have been added: – PWR_CR[FPDS] used to power down the Flash in Stop mode – PWR_CSR[BRE] used to enable/disable the Backup regulator
Color key:  = New feature or new architecture  = Same feature, but specification change or enhancement		

3.11 RTC

The STM32 F2 series embeds a new RTC peripheral vs. F1 series; the architecture, features and programming interface are different.

As a consequence the F2 RTC programming procedures and registers are different from the F1 series, i.e. any code on F1 series using the RTC needs to be rewritten to run on F2 series.

This new RTC provides best-in-class features:

- BCD timer/counter
- Time-of-day clock/calendar with programmable daylight saving compensation
- Two programmable alarm interrupts
- Digital calibration circuit
- Time-stamp function for event saving
- Periodic programmable wakeup flag with interrupt capability
- Automatic wakeup unit to manage low power modes
- 20 backup registers (80 bytes) which are reset when a tamper detection event occurs.

For more information about STM32 F2's RTC features, please refer to RTC chapter of STM32F2xx Reference Manual (RM0033).

For advanced information about the RTC programming, please refer to the Application Note AN3371 *Using the STM32 HW real-time clock (RTC)*.

3.12 Miscellaneous

3.12.1 Ethernet PHY interface selection

In STM32 F1 series the Ethernet PHY interface selection is done in the AFIO peripheral (MII_RMII_SEL bit in AFIO_MAPR register), while in F2 series this configuration is done in the SYSCFG peripheral (MII_RMII_SEL bit in SYSCFG_PMC register).

3.12.2 TIM2 internal trigger 1 (ITR1) remapping

The example below shows how to select USB OTG FS SOF output or ETH PTP trigger output as input for TIM2 ITR1 in STM32 F1 series:

1. In F1 series to select USB OTG FS SOF output as input for TIM2 ITR1, set to 1 the bit TIM2ITR1_IREMAP in AFIO_MAPR register. Reset this bit to 0 to connect the Ethernet PTP trigger output to TIM2 ITR1 input.
2. In F2 series to select USB OTG FS SOF output as input for TIM2 ITR1, set to [10] the bits ITR1_RMP[1:0] in TIM2_OR register. Set these bits to [01] connect the Ethernet PTP trigger output to TIM2 ITR1 input.

4 Firmware migration using the library

This section describes how to migrate an application based on STM32F1xx Standard Peripherals Library in order to use the STM32F2xx Standard Peripherals Library.

The STM32F1xx and STM32F2xx libraries have the same architecture and are CMSIS compliant, they use the same driver naming and the same APIs for all compatible peripheral.

Only a few peripheral drivers need to be updated to migrate the application from an F1 series product to an F2 series product.

Note: In the rest of this chapter (unless otherwise specified), the term “STM32F2xx Library” is used to refer to the STM32F2xx Standard Peripherals Library and the term “STM32F10x Library” is used to refer to the STM32F10x Standard Peripherals Library.

4.1 Migration steps

To update your application code to run on STM32F2xx Library, you have to follow the steps listed below:

1. Update the toolchain startup files
 - a) *Project files:* device connections and Flash memory loader. These files are provided with the latest version of your toolchain that supports STM32F2xxx devices. For more information please refer to your toolchain documentation.
 - b) *Linker configuration and vector table location files:* these files are developed following the CMSIS standard and are included in the STM32F2xx Library install package under the following directory:
`Libraries\CMSIS\CM3\DeviceSupport\ST\STM32F2xx\`
2. Add STM32F2xxx Library source files to the application sources
 - a) Replace the `stm32f10x_conf.h` file of your application with `stm32f2xx_conf.h` provided in STM32F2xx Library.
 - b) Replace the existing `stm32f10x_it.c/stm32f10x_it.h` files in your application with `stm32f2xx_it.c/stm32f2xx_it.h` provided in STM32F2xx Library.
3. Update the part of your application code that uses the RCC, DMA, GPIO, FLASH, ADC and RTC drivers. Further details are provided in the next section.

Note: The STM32F2xx Library comes with a rich set of examples (84 in total) demonstrating how to use the different peripherals (under `Project\STM32F2xx_StdPeriph_Examples`).

4.2 RCC

1. *System clock configuration:* as presented in [Section 3.4: RCC](#) the STM32 F2 and F1 series have the same clock sources and configuration procedures. However, there are some differences related to the PLL configuration, maximum frequency and Flash wait state configuration. Thanks to the CMSIS layer, these differences are hidden from the application code; you only have to replace the `system_stm32f10x.c` file by `system_stm32f2xx.c` file. This file provides an implementation of `SystemInit()` function

used to configure the microcontroller system at start-up and before branching to the main() program.

Note: For STM32F2xx you can use the clock configuration tool, *STM32F2xx_Clock_Configuration.xls*, to generate a customized *SystemInit()* function depending on your application requirements. For more information, refer to the application note AN3362 “Clock configuration tool for STM32F2xx microcontrollers”

2. **Peripheral access configuration:** as presented in [Section 3.4: RCC](#) you need to call different functions to [enable/disable] or [enter/exit] the peripheral [clock] or [from reset mode]. For example, GPIOA is mapped on AHB1 bus on F2 series (APB2 bus on F1 series), to enable its clock you have to use the `RCC_AHB1PeriphClockCmd(RCC_AHB1Periph_GPIOA, ENABLE);` function instead of: `RCC_APB2PeriphClockCmd(RCC_APB2Periph_GPIOA, ENABLE);` in the F1 series. Refer to [Table 3 on page 13](#) for the peripheral bus mapping changes between F2 and F1 series.

3. Peripheral clock configuration

- a) **I2S:** in STM32 F2 series the I2S clock can be derived either from a specific PLL (PLLI2S) or from an external clock mapped on the I2S_CKIN pin. Refer to the code given below, that should be used in both cases:

```

/*****
/*                               PLLI2S used as I2S clock source                               */
/*****
/* Select PLLI2S as I2S clock source */
RCC_I2SCLKConfig(RCC_I2S2CLKSource_PLLI2S);

/* Configure the PLLI2S clock multiplication and division factors
   Note: PLLI2S clock source is common with the main PLL (configured in
        RCC_PLLConfig function )
*/
RCC_PLLI2SConfig(PLLI2SN, PLLI2SR);

/* Enable PLLI2S */
RCC_PLLI2SCmd(ENABLE);

/* Wait till PLLI2S is ready */
while(RCC_GetFlagStatus(RCC_FLAG_PLLI2SRDY) == 0)
{
}

/* Enable I2Sx's APB interface clock (I2S2/3 are subset of SPI2/3 peripherals) */
RCC_APB1PeriphClockCmd(RCC_APB1Periph_SPIx, ENABLE);

/*****
/*                               External clock used as I2S clock source                               */
/*****
/* Select External clock mapped on the I2S_CKIN pin as I2S clock source */
RCC_I2SCLKConfig(RCC_I2S2CLKSource_Ext);

/* Enable I2Sx's APB interface clock (I2S2/3 are subset of SPI2/3 peripherals) */
RCC_APB1PeriphClockCmd(RCC_APB1Periph_SPIx, ENABLE);

```

- b) **USB OTG FS and SDIO:** in STM32 F2 series the USB OTG FS requires a frequency of 48 MHz to work correctly, while the SDIO requires a frequency of less

than or equal to 48 MHz to work correctly. The following is an example of the main PLL configuration to obtain 120 MHz as system clock frequency and 48 MHz for the OTG FS and SDIO.

```

/* PLL_VCO = (HSE_VALUE / PLL_M) * PLL_N = 240 MHz */
#define PLL_M      25
#define PLL_N      240

/* SYSCLK = PLL_VCO / PLL_P = 120 MHz */
#define PLL_P      2

/* USB OTG FS, SDIO and RNG Clock = PLL_VCO / PLLQ = 48 MHz */
#define PLL_Q      5

...
/* Configure the main PLL */
RCC_PLLConfig(RCC_PLLSource_HSE, PLL_M, PLL_N, PLL_P, PLL_Q, 0);

/* Wait till PLL is ready */
while(RCC_GetFlagStatus(RCC_FLAG_PLLRDY) == 0)
{
}
...
/* Enable USB OTG FS's AHB interface clock */
RCC_AHB2PeriphClockCmd(RCC_AHB2Periph_OTG_FS, ENABLE);

/* Enable SDIO's APB interface clock */
RCC_APB2PeriphClockCmd(RCC_APB2Periph_SDIO, ENABLE);

```

c) **ADC**: in STM32 F2 series the ADC features two clock schemes:

- Clock for the analog circuitry: ADCCLK, common to all ADCs. This clock is generated from the APB2 clock divided by a programmable prescaler that allows the ADC to work at $f_{PCLK2}/2, /4, /6$ or $/8$. The maximum value of ADCCLK is 30 MHz when the APB2 clock is at 60 MHz. This configuration is done using the ADC registers.
- Clock for the digital interface (used for register read/write access). This clock is equal to the APB2 clock. The digital interface clock can be enabled/disabled individually for each ADC through the RCC APB2 peripheral clock enable register (RCC_APB2ENR). However, there is only a single bit to reset the three ADCs at the same time.

```

/* Enable APB interface clock for ADC1, ADC2 and ADC3 */
RCC_APB2PeriphClockCmd(RCC_APB2Periph_ADC1 | RCC_APB2Periph_ADC2 |
                       RCC_APB2Periph_ADC3, ENABLE);

/* Reset ADC1, ADC2 and ADC3 */
RCC_APB2PeriphResetCmd(RCC_APB2Periph_ADC, ENABLE);
RCC_APB2PeriphResetCmd(RCC_APB2Periph_ADC, DISABLE);

```



4.3 FLASH

The table below presents the correspondence between the FLASH driver APIs in the STM32F10x and STM32F2xx Libraries. You can easily update your application code by replacing STM32F10x functions by the corresponding function in STM32F2xx Library.

Table 13. STM32F10x and STM32F2xx FLASH driver API correspondence

	STM32F10x Flash driver API	STM32F2xx Flash driver API
Interface configuration	void FLASH_SetLatency(uint32_t FLASH_Latency);	void FLASH_SetLatency(uint32_t FLASH_Latency);
	void FLASH_PrefetchBufferCmd(uint32_t FLASH_PrefetchBuffer);	void FLASH_PrefetchBufferCmd(FunctionalState NewState);
	void FLASH_HalfCycleAccessCmd(uint32_t FLASH_HalfCycleAccess);	NA
	NA	void FLASH_InstructionCacheCmd(FunctionalState NewState);
	NA	void FLASH_DataCacheCmd(FunctionalState NewState);
	NA	void FLASH_InstructionCacheReset(void);
	NA	void FLASH_DataCacheReset(void);
	void FLASH_ITConfig(uint32_t FLASH_IT, FunctionalState NewState);	void FLASH_ITConfig(uint32_t FLASH_IT, FunctionalState NewState);
Memory Programming	void FLASH_Unlock(void);	void FLASH_Unlock(void);
	void FLASH_Lock(void);	void FLASH_Lock(void);
	FLASH_Status FLASH_ErasePage(uint32_t Page_Address);	FLASH_Status FLASH_EraseSector(uint32_t FLASH_Sector);
	FLASH_Status FLASH_EraseAllPages(void);	FLASH_Status FLASH_EraseAllSectors(void);
	FLASH_Status FLASH_EraseOptionBytes(void);	NA
	NA	FLASH_Status FLASH_ProgramDoubleWord(uint32_t Address, uint64_t Data);
	FLASH_Status FLASH_ProgramWord(uint32_t Address, uint32_t Data);	FLASH_Status FLASH_ProgramWord(uint32_t Address, uint32_t Data);
	FLASH_Status FLASH_ProgramHalfWord(uint32_t Address, uint16_t Data);	FLASH_Status FLASH_ProgramHalfWord(uint32_t Address, uint16_t Data);
	NA	FLASH_Status FLASH_ProgramByte(uint32_t Address, uint8_t Data);

Table 13. STM32F10x and STM32F2xx FLASH driver API correspondence (continued)

	STM32F10x Flash driver API	STM32F2xx Flash driver API
Option Byte Programming	NA	void FLASH_OB_Unlock(void);
	NA	void FLASH_OB_Lock(void);
	FLASH_Status FLASH_ProgramOptionByteData(uint32_t Address, uint8_t Data);	NA
	FLASH_Status FLASH_EnableWriteProtection(uint32_t FLASH_Pages);	void FLASH_OB_WRPConfig(uint32_t OB_WRP, FunctionalState NewState);
	FLASH_Status FLASH_ReadOutProtection(FunctionalState NewState);	void FLASH_OB_RDPCConfig(uint8_t OB_RDP);
	FLASH_Status FLASH_UserOptionByteConfig(uint16_t OB_IWDG, uint16_t OB_STOP, uint16_t OB_STDBY);	void FLASH_OB_UserConfig(uint8_t OB_IWDG, uint8_t OB_STOP, uint8_t OB_STDBY);
	NA	void FLASH_OB_BORConfig(uint8_t OB_BOR);
	NA	FLASH_Status FLASH_OB_Launch(void);
	uint32_t FLASH_GetUserOptionByte(void);	uint8_t FLASH_OB_GetUser(void);
	uint32_t FLASH_GetWriteProtectionOptionByte(void);	uint16_t FLASH_OB_GetWRP(void);
	FlagStatus FLASH_GetReadOutProtectionStatus(void);	FlagStatus FLASH_OB_GetRDP(void);
	NA	uint8_t FLASH_OB_GetBOR(void);
FLAG management	FlagStatus FLASH_GetFlagStatus(uint32_t FLASH_FLAG);	FlagStatus FLASH_GetFlagStatus(uint32_t FLASH_FLAG);
	void FLASH_ClearFlag(uint32_t FLASH_FLAG);	void FLASH_ClearFlag(uint32_t FLASH_FLAG);
	FLASH_Status FLASH_GetStatus(void);	FLASH_Status FLASH_GetStatus(void);
	FLASH_Status FLASH_WaitForLastOperation(uint32_t Timeout);	FLASH_Status FLASH_WaitForLastOperation(void);
	FlagStatus FLASH_GetPrefetchBufferStatus(void);	NA
<p>Color key:</p> <p> = New function</p> <p> = Same function, but API was changed</p> <p> = Function not available (NA)</p>		

4.4 GPIO

This section explain how to update the configuration of the different GPIO modes when moving the application code from STM32 F1 series to F2 series.

4.4.1 Output mode

The example below shows how to configure an I/O in output mode (for example to drive an LED) in STM32 F1 series:

```
GPIO_InitStructure.GPIO_Pin = GPIO_Pin_x;
GPIO_InitStructure.GPIO_Speed = GPIO_Speed_xxMHz; /* 2, 10 or 50 MHz */
GPIO_InitStructure.GPIO_Mode = GPIO_Mode_Out_PP;
GPIO_Init(GPIOy, &GPIO_InitStructure);
```

In F2 series you have to update this code as follows:

```
GPIO_InitStructure.GPIO_Pin = GPIO_Pin_x;
GPIO_InitStructure.GPIO_Mode = GPIO_Mode_OUT;
GPIO_InitStructure.GPIO_OType = GPIO_OType_PP; /* Push-pull or open drain */
GPIO_InitStructure.GPIO_PuPd = GPIO_PuPd_UP; /* None, Pull-up or pull-down */
GPIO_InitStructure.GPIO_Speed = GPIO_Speed_xxMHz; /* 2, 25, 50 or 100 MHz */
GPIO_Init(GPIOy, &GPIO_InitStructure);
```

4.4.2 Input mode

The example below shows how to configure an I/O in input mode (for example to be used as an EXTI line) in STM32 F1 series:

```
GPIO_InitStructure.GPIO_Pin = GPIO_Pin_x;
GPIO_InitStructure.GPIO_Mode = GPIO_Mode_IN_FLOATING;
GPIO_Init(GPIOy, &GPIO_InitStructure);
```

In F2 series you have to update this code as follows:

```
GPIO_InitStructure.GPIO_Pin = GPIO_Pin_x;
GPIO_InitStructure.GPIO_Mode = GPIO_Mode_IN;
GPIO_InitStructure.GPIO_PuPd = GPIO_PuPd_NOPULL; /* None, Pull-up or pull-down */
GPIO_Init(GPIOy, &GPIO_InitStructure);
```

4.4.3 Analog mode

The example below shows how to configure an I/O in analog mode (for example an ADC or DAC channel) in STM32 F1 series:

```
GPIO_InitStructure.GPIO_Pin = GPIO_Pin_x;
GPIO_InitStructure.GPIO_Mode = GPIO_Mode_AIN;
GPIO_Init(GPIOy, &GPIO_InitStructure);
```

In F2 series you have to update this code as follows:

```
GPIO_InitStructure.GPIO_Pin = GPIO_Pin_x ;
GPIO_InitStructure.GPIO_Mode = GPIO_Mode_AIN;
GPIO_InitStructure.GPIO_PuPd = GPIO_PuPd_NOPULL ;
GPIO_Init(GPIOy, &GPIO_InitStructure);
```

4.4.4 Alternate function mode

In STM32 F1 series

1. The configuration to use an I/O as alternate function depends on the peripheral mode used. For example, the USART Tx pin should be configured as alternate function push-pull while the USART Rx pin should be configured as input floating or input pull-up.
2. To optimize the number of peripherals available in MCUs that have fewer pins (smaller package size), it is possible by software to remap some alternate functions to other

pins. for example the USART2_RX pin can be mapped on PA3 (default remap) or PD6 (done through software remap) pin.

In STM32 F2 series

1. Whatever the peripheral mode used, the I/O must be configured as alternate function, then the system can use the I/O in the proper way (input or output).
2. The I/O pins are connected to onboard peripherals/modules through a multiplexer that allows only one peripheral's alternate function to be connected to an I/O pin at a time. In this way, there can be no conflict between peripherals sharing the same I/O pin. Each I/O pin has a multiplexer with sixteen alternate function inputs (AF0 to AF15) that can be configured through the GPIO_PinAFConfig () function:
 - After reset all I/Os are connected to the system's alternate function 0 (AF0)
 - The peripherals' alternate functions are mapped from AF1 to AF13
 - Cortex-M3 EVENTOUT is mapped on AF15
3. In addition to this flexible I/O multiplexing architecture, each peripheral has alternate functions mapped onto different I/O pins to optimize the number of peripheral I/O functions for different device packages. For example, the USART2_RX pin can be mapped on PA3 or PD6 pin
4. Configuration procedure
 - Connect the pin to the desired peripherals' Alternate Function (AF) using GPIO_PinAFConfig() function
 - Use GPIO_Init() function to configure the I/O pin:
 - Configure the desired pin in alternate function mode using GPIO_InitStructure->GPIO_Mode = GPIO_Mode_AF;
 - Select the type, pull-up/pull-down and output speed via GPIO_PuPd, GPIO_OType and GPIO_Speed members

The example below shows how to remap USART2 Tx/Rx I/Os on PD5/PD6 pins in STM32 F1 series:

```

/* Enable APB2 interface clock for GPIOD and AFIO (AFIO peripheral is used
   to configure the I/Os software remapping) */
RCC_APB2PeriphClockCmd(RCC_APB2Periph_GPIOD | RCC_APB2Periph_AFIO, ENABLE);

/* Enable USART2 I/Os software remapping [(USART2_Tx,USART2_Rx):(PD5,PD6)] */
GPIO_PinRemapConfig(GPIO_Remap_USART2, ENABLE);

/* Configure USART2_Tx as alternate function push-pull */
GPIO_InitStructure.GPIO_Pin = GPIO_Pin_5;
GPIO_InitStructure.GPIO_Mode = GPIO_Mode_AF_PP;
GPIO_InitStructure.GPIO_Speed = GPIO_Speed_50MHz;
GPIO_Init(GPIOD, &GPIO_InitStructure);

/* Configure USART2_Rx as input floating */
GPIO_InitStructure.GPIO_Pin = GPIO_Pin_6;
GPIO_InitStructure.GPIO_Mode = GPIO_Mode_IN_FLOATING;
GPIO_Init(GPIOD, &GPIO_InitStructure);

```

In F2 series you have to update this code as follows:

```

/* Enable GPIOD's AHB interface clock */
RCC_AHB1PeriphClockCmd(RCC_AHB1Periph_GPIOD, ENABLE);

/* Select USART2 I/Os mapping on PD5/6 pins [(USART2_TX,USART2_RX):(PD5,PD6)] */
/* Connect PD5 to USART2_Tx */

```

```

GPIO_PinAFConfig(GPIOD, GPIO_PinSource5, GPIO_AF_USART2);
/* Connect PD6 to USART2_Rx*/
GPIO_PinAFConfig(GPIOD, GPIO_PinSource6, GPIO_AF_USART2);

/* Configure USART2_Tx and USART2_Rx as alternate function */
GPIO_InitStructure.GPIO_Pin = GPIO_Pin_5 | GPIO_Pin_6;
GPIO_InitStructure.GPIO_Mode = GPIO_Mode_AF;
GPIO_InitStructure.GPIO_Speed = GPIO_Speed_50MHz;
GPIO_InitStructure.GPIO_OType = GPIO_OType_PP;
GPIO_InitStructure.GPIO_PuPd = GPIO_PuPd_UP;
GPIO_Init(GPIOD, &GPIO_InitStructure);

```

Note: *When the I/O speed is configured in 50 MHz or 100 MHz mode, it is recommended to use the compensation cell for slew rate control to reduce the I/O noise on the power supply.*

4.5 EXTI

The example below shows how to configure the PA0 pin to be used as EXTI Line0 in STM32 F1 series:

```

/* Enable APB interface clock for GPIOA and AFIO */
RCC_APB2PeriphClockCmd(RCC_APB2Periph_GPIOA | RCC_APB2Periph_AFIO, ENABLE);

/* Configure PA0 pin in input mode */
GPIO_InitStructure.GPIO_Pin = GPIO_Pin_0;
GPIO_InitStructure.GPIO_Mode = GPIO_Mode_IN_FLOATING;
GPIO_Init(GPIOA, &GPIO_InitStructure);

/* Connect EXTI Line0 to PA0 pin */
GPIO_EXTILineConfig(GPIO_PortSourceGPIOA, GPIO_PinSource0);

/* Configure EXTI line0 */
EXTI_InitStructure.EXTI_Line = EXTI_Line0;
EXTI_InitStructure.EXTI_Mode = EXTI_Mode_Interrupt;
EXTI_InitStructure.EXTI_Trigger = EXTI_Trigger_Falling;
EXTI_InitStructure.EXTI_LineCmd = ENABLE;
EXTI_Init(&EXTI_InitStructure);

```

In F2 series the configuration of the EXTI line source pin is performed in the SYSCFG peripheral (instead of AFIO in F1 series). As result, the source code should be updated as follows:

```

/* Enable GPIOA's AHB interface clock */
RCC_AHB1PeriphClockCmd(RCC_AHB1Periph_GPIOA, ENABLE);
/* Enable SYSCFG's APB interface clock */
RCC_APB2PeriphClockCmd(RCC_APB2Periph_SYSCFG, ENABLE);

/* Configure PA0 pin in input mode */
GPIO_InitStructure.GPIO_Pin = GPIO_Pin_0;
GPIO_InitStructure.GPIO_Mode = GPIO_Mode_IN;
GPIO_InitStructure.GPIO_PuPd = GPIO_PuPd_NOPULL;
GPIO_Init(GPIOA, &GPIO_InitStructure);

/* Connect EXTI Line0 to PA0 pin */
SYSCFG_EXTILineConfig(EXTI_PortSourceGPIOA, EXTI_PinSource0);

/* Configure EXTI line0 */
EXTI_InitStructure.EXTI_Line = EXTI_Line0;
EXTI_InitStructure.EXTI_Mode = EXTI_Mode_Interrupt;
EXTI_InitStructure.EXTI_Trigger = EXTI_Trigger_Falling;
EXTI_InitStructure.EXTI_LineCmd = ENABLE;
EXTI_Init(&EXTI_InitStructure);

```

4.6 DMA

This section shows through an example how to port existing code from STM32 F1 series to F2 series.

The example below shows how to configure the DMA to transfer continuously converted data from ADC1 to SRAM memory in STM32 F1 series:

```
#define ADC1_DR_ADDRESS    ((uint32_t)0x4001244C)
...
uint16_t ADCConvertedValue = 0;

...
/* Enable DMA1's AHB interface clock */
RCC_AHBPeriphClockCmd(RCC_AHBPeriph_DMA1, ENABLE);

/* Configure DMA1 channel1 to transfer, in circular mode, the converted data from
ADC1 DR register to the ADCConvertedValue variable */
DMA_InitStructure.DMA_PeripheralBaseAddr = ADC1_DR_Address;
DMA_InitStructure.DMA_MemoryBaseAddr = (uint32_t)&ADCConvertedValue;
DMA_InitStructure.DMA_DIR = DMA_DIR_PeripheralSRC;
DMA_InitStructure.DMA_BufferSize = 1;
DMA_InitStructure.DMA_PeripheralInc = DMA_PeripheralInc_Disable;
DMA_InitStructure.DMA_MemoryInc = DMA_MemoryInc_Disable;
DMA_InitStructure.DMA_PeripheralDataSize = DMA_PeripheralDataSize_HalfWord;
DMA_InitStructure.DMA_MemoryDataSize = DMA_MemoryDataSize_HalfWord;
DMA_InitStructure.DMA_Mode = DMA_Mode_Circular;
DMA_InitStructure.DMA_Priority = DMA_Priority_High;
DMA_InitStructure.DMA_M2M = DMA_M2M_Disable;
DMA_Init(DMA1_Channel1, &DMA_InitStructure);

/* Enable DMA1 channel1 */
DMA_Cmd(DMA1_Channel1, ENABLE);
```

In F2 series you have to update this code as follows:

```
#define ADC1_DR_ADDRESS    ((uint32_t)0x4001204C)
...
uint16_t ADCConvertedValue = 0;

...
/* Enable DMA2's AHB1 interface clock */
RCC_AHB1PeriphClockCmd(RCC_AHB1Periph_DMA2, ENABLE);

/* Configure DMA2 Stream0 channel0 to transfer, in circular mode, the converted
data from ADC1 DR register to the ADCConvertedValue variable */
DMA_InitStructure.DMA_Channel = DMA_Channel_0;
DMA_InitStructure.DMA_PeripheralBaseAddr = ADC1_DR_ADDRESS;
DMA_InitStructure.DMA_Memory0BaseAddr = (uint32_t)&ADCConvertedValue;
DMA_InitStructure.DMA_DIR = DMA_DIR_PeripheralToMemory;
DMA_InitStructure.DMA_BufferSize = 1;
DMA_InitStructure.DMA_PeripheralInc = DMA_PeripheralInc_Disable;
DMA_InitStructure.DMA_MemoryInc = DMA_MemoryInc_Disable;
DMA_InitStructure.DMA_PeripheralDataSize = DMA_PeripheralDataSize_HalfWord;
DMA_InitStructure.DMA_MemoryDataSize = DMA_MemoryDataSize_HalfWord;
DMA_InitStructure.DMA_Mode = DMA_Mode_Circular;
DMA_InitStructure.DMA_Priority = DMA_Priority_High;
DMA_InitStructure.DMA_FIFOMode = DMA_FIFOMode_Disable;
DMA_InitStructure.DMA_FIFOThreshold = DMA_FIFOThreshold_HalfFull;
DMA_InitStructure.DMA_MemoryBurst = DMA_MemoryBurst_Single;
DMA_InitStructure.DMA_PeripheralBurst = DMA_PeripheralBurst_Single;
DMA_Init(DMA2_Stream0, &DMA_InitStructure);

/* Enable DMA2 Stream0 */
```

```
DMA_Cmd(DMA2_Stream0, ENABLE);
```

The source code changes in DMA_InitStructure members are indicated in **Bold** and ***BoldItalic***:

1. The structure members indicated in **Bold** were added vs. STM32 F1 series and used to configure the DMA FIFO mode and its Threshold, Burst mode for source and/or destination.
2. The name of the structure members indicated in ***BoldItalic*** were changed vs. STM32 F1 series
 - a) In *STM32F2xx* Library the name of “DMA_MemoryBaseAddr” member was changed to “DMA_Memory**0**BaseAddr”, since the DMA is able to manage two buffers for data transfer:
 - “DMA_Memory**0**BaseAddr”: specifies the memory base address for DMAy Streamx, it’s the default memory used when double buffer mode is not enabled.
 - “DMA_Memory**1**BaseAddr”: specifies the base address of the second buffer, when buffer mode is enabled.
 - b) In *STM32F2xx* Library the possible values of “DMA_DIR” member were changed to “DMA_DIR_PeripheralToMemory”, “DMA_DIR_MemoryToPeripheral” and “DMA_DIR_MemoryToMemory”.

4.7 ADC

This section gives an example of how to port existing code from STM32 F1 series to F2 series.

The example below shows how to configure the ADC1 to continuously convert channel14 in STM32 F1 series:

```
...
/* ADCCLK = PCLK2/4 */
RCC_ADCClockConfig(RCC_PCLK2_Div4);

/* Enable ADC's APB interface clock */
RCC_APB2PeriphClockCmd(RCC_APB2Periph_ADC1, ENABLE);

/* Configure ADC1 to convert continuously channel14 */
ADC_InitStructure.ADC_Mode = ADC_Mode_Independent;
ADC_InitStructure.ADC_ScanConvMode = ENABLE;
ADC_InitStructure.ADC_ContinuousConvMode = ENABLE;
ADC_InitStructure.ADC_ExternalTrigConv = ADC_ExternalTrigConv_None;
ADC_InitStructure.ADC_DataAlign = ADC_DataAlign_Right;
ADC_InitStructure.ADC_NbrOfChannel = 1;
ADC_Init(ADC1, &ADC_InitStructure);
/* ADC1 regular channel14 configuration */
ADC_RegularChannelConfig(ADC1, ADC_Channel_14, 1, ADC_SampleTime_55Cycles5);

/* Enable ADC1's DMA interface */
ADC_DMACmd(ADC1, ENABLE);

/* Enable ADC1 */
ADC_Cmd(ADC1, ENABLE);

/* Enable ADC1 reset calibration register */
ADC_ResetCalibration(ADC1);
/* Check the end of ADC1 reset calibration register */
while(ADC_GetResetCalibrationStatus(ADC1));
```

```

/* Start ADC1 calibration */
ADC_StartCalibration(ADC1);
/* Check the end of ADC1 calibration */
while(ADC_GetCalibrationStatus(ADC1));

/* Start ADC1 Software Conversion */
ADC_SoftwareStartConvCmd(ADC1, ENABLE);
...

```

In F2 series you have to update this code as follows:

```

...
/* Enable ADC's APB interface clock */
RCC_APB2PeriphClockCmd(RCC_APB2Periph_ADC1, ENABLE);

/* Common configuration (applicable for the three ADCs) *****/
/* Single ADC mode */
ADC_CommonInitStructure.ADC_Mode = ADC_Mode_Independent;
/* ADCCLK = PCLK2/2 */
ADC_CommonInitStructure.ADC_Prescaler = ADC_Prescaler_Div2;
/* Available only for multi ADC mode */
ADC_CommonInitStructure.ADC_DMAAccessMode = ADC_DMAAccessMode_Disabled;
/* Delay between 2 sampling phases */
ADC_CommonInitStructure.ADC_TwoSamplingDelay = ADC_TwoSamplingDelay_5Cycles;
ADC_CommonInit(&ADC_CommonInitStructure);

/* Configure ADC1 to convert continuously channel14 *****/
ADC_InitStructure.ADC_Resolution = ADC_Resolution_12b;
ADC_InitStructure.ADC_ScanConvMode = DISABLE;
ADC_InitStructure.ADC_ContinuousConvMode = ENABLE;
ADC_InitStructure.ADC_ExternalTrigConvEdge = ADC_ExternalTrigConvEdge_None;
ADC_InitStructure.ADC_DataAlign = ADC_DataAlign_Right;
ADC_InitStructure.ADC_NbrOfConversion = 1;
ADC_Init(ADC1, &ADC_InitStructure);
/* ADC1 regular channel14 configuration */
ADC_RegularChannelConfig(ADC1, ADC_Channel_14, 1, ADC_SampleTime_3Cycles);

/* Enable DMA request after last transfer (Single-ADC mode) */
ADC_DMAResquestAfterLastTransferCmd(ADC1, ENABLE);

/* Enable ADC1's DMA interface */
ADC_DMACmd(ADC1, ENABLE);

/* Enable ADC1 */
ADC_Cmd(ADC1, ENABLE);

/* Start ADC1 Software Conversion */
ADC_SoftwareStartConv(ADC1);
...

```

The main changes in the source code/procedure in F2 series vs. F1 are described below:

1. ADC configuration is done by two functions: `ADC_CommonInit()` and `ADC_Init()`. The `ADC_CommonInit()` function is used to configure parameters common to the three ADCs, including the ADC analog clock prescaler.
2. To enable the generation of DMA requests continuously at the end of the last DMA transfer, the `ADC_DMAResquestAfterLastTransferCmd()` function should be used.
3. No calibration is needed.

4.8 Backup data registers

In STM32 F1 series the Backup data registers are managed through the BKP peripheral, while in F2 series they are a part of the RTC peripheral (there is no BKP peripheral).

The example below shows how to write to/read from Backup data registers in STM32 F1 series:

```
uint16_t BKPdata = 0;

...
/* Enable APB2 interface clock for PWR and BKP */
RCC_APB1PeriphClockCmd(RCC_APB1Periph_PWR | RCC_APB1Periph_BKP, ENABLE);

/* Enable write access to Backup domain */
PWR_BackupAccessCmd(ENABLE);

/* Write data to Backup data register 1 */
BKP_WriteBackupRegister(BKP_DR1, 0x3210);

/* Read data from Backup data register 1 */
BKPdata = BKP_ReadBackupRegister(BKP_DR1);
```

In F2 series you have to update this code as follows:

```
uint16_t BKPdata = 0;

...
/* PWR Clock Enable */
RCC_APB1PeriphClockCmd(RCC_APB1Periph_PWR, ENABLE);

/* Enable write access to Backup domain */
PWR_RTCAccessCmd(ENABLE);

/* Write data to Backup data register 1 */
RTC_WriteBackupRegister(RTC_BKP_DR1, 0x3220);

/* Read data from Backup data register 1 */
BKPdata = RTC_ReadBackupRegister(RTC_BKP_DR1);
```

The main changes in the source code in F2 series vs. F1 are described below:

1. There is no BKP peripheral
2. Write to/read from Backup data registers are done through RTC driver
3. Backup data registers naming changed from BKP_DRx to RTC_BKP_DRx, and numbering starts from 0 instead of 1

4.9 Miscellaneous

4.9.1 Ethernet PHY interface selection

In STM32 F1 series the Ethernet PHY interface selection is made in the AFIO peripheral, while in F2 series this configuration is made in the SYSCFG peripheral.

The example below shows how to configure the Ethernet PHY interface in STM32 F1 series:

```
/* Configure Ethernet MAC for connection with an MII PHY */
GPIO_ETH_MediaInterfaceConfig(GPIO_ETH_MediaInterface_MII);
```

```
/* Configure Ethernet MAC for connection with an RMII PHY */  
GPIO_ETH_MediaInterfaceConfig(GPIO_ETH_MediaInterface_RMII);
```

In F2 series you have to update this code as follows:

```
/* Configure Ethernet MAC for connection with an MII PHY */  
SYSCFG_ETH_MediaInterfaceConfig(SYSCFG_ETH_MediaInterface_MII);  
  
/* Configure Ethernet MAC for connection with an RMII PHY */  
SYSCFG_ETH_MediaInterfaceConfig(SYSCFG_ETH_MediaInterface_RMII);
```

4.9.2 TIM2 internal trigger 1 (ITR1) remapping

The example below shows how to select USB OTG FS SOF output or ETH PTP trigger output as input for TIM2 ITR1 in STM32 F1 series:

```
/* Connect USB OTG FS SOF output to TIM2 ITR1 input */  
GPIO_PinRemapConfig(GPIO_Remap_TIM2ITR1_PTP_SOF, ENABLE);  
  
/* Connect ETH PTP trigger output to TIM2 ITR1 input */  
GPIO_PinRemapConfig(GPIO_Remap_TIM2ITR1_PTP_SOF, DISABLE);
```

In F2 series you have to update this code as follows:

```
/* Connect USB OTG FS SOF output to TIM2 ITR1 input */  
TIM_RemapConfig(TIM2, TIM2_USBFS_SOF);  
  
/* Connect ETH PTP trigger output to TIM2 ITR1 input */  
TIM_RemapConfig(TIM2, TIM2_ETH_PTP);
```

5 Revision history

Table 14. Document revision history

Date	Revision	Changes
20-July-2011	1	Initial release

Please Read Carefully:

Information in this document is provided solely in connection with ST products. STMicroelectronics NV and its subsidiaries ("ST") reserve the right to make changes, corrections, modifications or improvements, to this document, and the products and services described herein at any time, without notice.

All ST products are sold pursuant to ST's terms and conditions of sale.

Purchasers are solely responsible for the choice, selection and use of the ST products and services described herein, and ST assumes no liability whatsoever relating to the choice, selection or use of the ST products and services described herein.

No license, express or implied, by estoppel or otherwise, to any intellectual property rights is granted under this document. If any part of this document refers to any third party products or services it shall not be deemed a license grant by ST for the use of such third party products or services, or any intellectual property contained therein or considered as a warranty covering the use in any manner whatsoever of such third party products or services or any intellectual property contained therein.

UNLESS OTHERWISE SET FORTH IN ST'S TERMS AND CONDITIONS OF SALE ST DISCLAIMS ANY EXPRESS OR IMPLIED WARRANTY WITH RESPECT TO THE USE AND/OR SALE OF ST PRODUCTS INCLUDING WITHOUT LIMITATION IMPLIED WARRANTIES OF MERCHANTABILITY, FITNESS FOR A PARTICULAR PURPOSE (AND THEIR EQUIVALENTS UNDER THE LAWS OF ANY JURISDICTION), OR INFRINGEMENT OF ANY PATENT, COPYRIGHT OR OTHER INTELLECTUAL PROPERTY RIGHT.

UNLESS EXPRESSLY APPROVED IN WRITING BY TWO AUTHORIZED ST REPRESENTATIVES, ST PRODUCTS ARE NOT RECOMMENDED, AUTHORIZED OR WARRANTED FOR USE IN MILITARY, AIR CRAFT, SPACE, LIFE SAVING, OR LIFE SUSTAINING APPLICATIONS, NOR IN PRODUCTS OR SYSTEMS WHERE FAILURE OR MALFUNCTION MAY RESULT IN PERSONAL INJURY, DEATH, OR SEVERE PROPERTY OR ENVIRONMENTAL DAMAGE. ST PRODUCTS WHICH ARE NOT SPECIFIED AS "AUTOMOTIVE GRADE" MAY ONLY BE USED IN AUTOMOTIVE APPLICATIONS AT USER'S OWN RISK.

Resale of ST products with provisions different from the statements and/or technical features set forth in this document shall immediately void any warranty granted by ST for the ST product or service described herein and shall not create or extend in any manner whatsoever, any liability of ST.

ST and the ST logo are trademarks or registered trademarks of ST in various countries.

Information in this document supersedes and replaces all information previously supplied.

The ST logo is a registered trademark of STMicroelectronics. All other names are the property of their respective owners.

© 2011 STMicroelectronics - All rights reserved

STMicroelectronics group of companies

Australia - Belgium - Brazil - Canada - China - Czech Republic - Finland - France - Germany - Hong Kong - India - Israel - Italy - Japan - Malaysia - Malta - Morocco - Philippines - Singapore - Spain - Sweden - Switzerland - United Kingdom - United States of America

www.st.com