

## Ultra low drop voltage regulators compatible with low ESR output capacitors

Datasheet - production data

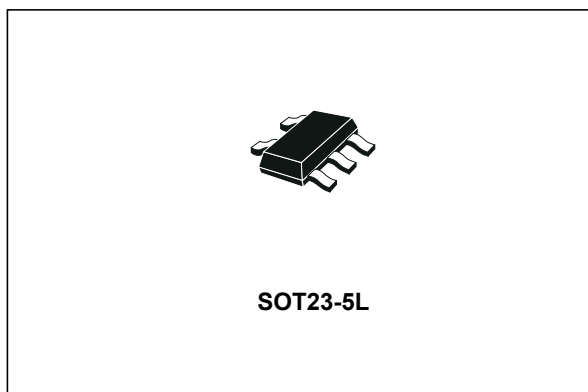

### Description

The low drop voltage and the ultra low quiescent current make them suitable for low noise, low power applications and in battery powered systems. The quiescent current in sleep mode is less than 1  $\mu\text{A}$  when the INHIBIT pin is pulled low. A shutdown logic control function is available on pin n° 3 (TTL compatible). This means that when the device is used as a local regulator, it is possible to put part of the board in standby, decreasing the total power consumption. The LD2980 is designed to work with low ESR ceramic capacitors. Typical applications are instrumentation, SMPS, audio systems, and industrial control boards.

### Features

- Stable with low ESR ceramic capacitors
- Ultra low dropout voltage (0.12 V typ. at 50 mA load, 7 mV typ. at 1 mA load)
- Very low quiescent current (80  $\mu\text{A}$  typ. at no load in on mode; max 1  $\mu\text{A}$  in off mode)
- Guaranteed output current up to 50 mA
- Logic-controlled electronic shutdown
- Output voltage of 1.8 V; 3.0 V; 3.3 V
- Internal current and thermal limit
- $\pm 0.5\%$  tolerance output voltage available (A version)
- Output low noise voltage 160  $\mu\text{VRMS}$
- Temperature range: -40 to 125 °C
- Smallest package SOT23-5L
- Fast dynamic response to line and load changes

**Table 1. Device summary**

Part numbers		
AB version	C version	Output voltage
	LD2980CM18TR	1.8 V
LD2980ABM30TR		3.0 V
LD2980ABM33TR	LD2980CM33TR	3.3 V

# Contents

<b>1</b>	<b>Diagram</b> .....	<b>3</b>
<b>2</b>	<b>Pin configuration</b> .....	<b>4</b>
<b>3</b>	<b>Maximum ratings</b> .....	<b>5</b>
<b>4</b>	<b>Typical application</b> .....	<b>6</b>
<b>5</b>	<b>Electrical characteristics</b> .....	<b>7</b>
<b>6</b>	<b>Typical performance characteristics</b> .....	<b>11</b>
<b>7</b>	<b>Application notes</b> .....	<b>15</b>
	7.1 External capacitors .....	15
	7.2 Input capacitor .....	15
	7.3 Output capacitor .....	15
	7.4 Important .....	15
	7.5 Inhibit input operation .....	15
	7.6 Reverse current .....	16
<b>8</b>	<b>Package information</b> .....	<b>17</b>
	8.1 SOT23-5L package information .....	17
<b>9</b>	<b>Packaging information</b> .....	<b>19</b>
	9.1 SOT23-5L packaging information .....	19
<b>10</b>	<b>Revision history</b> .....	<b>21</b>

# 1 Diagram

Figure 1. Schematic diagram

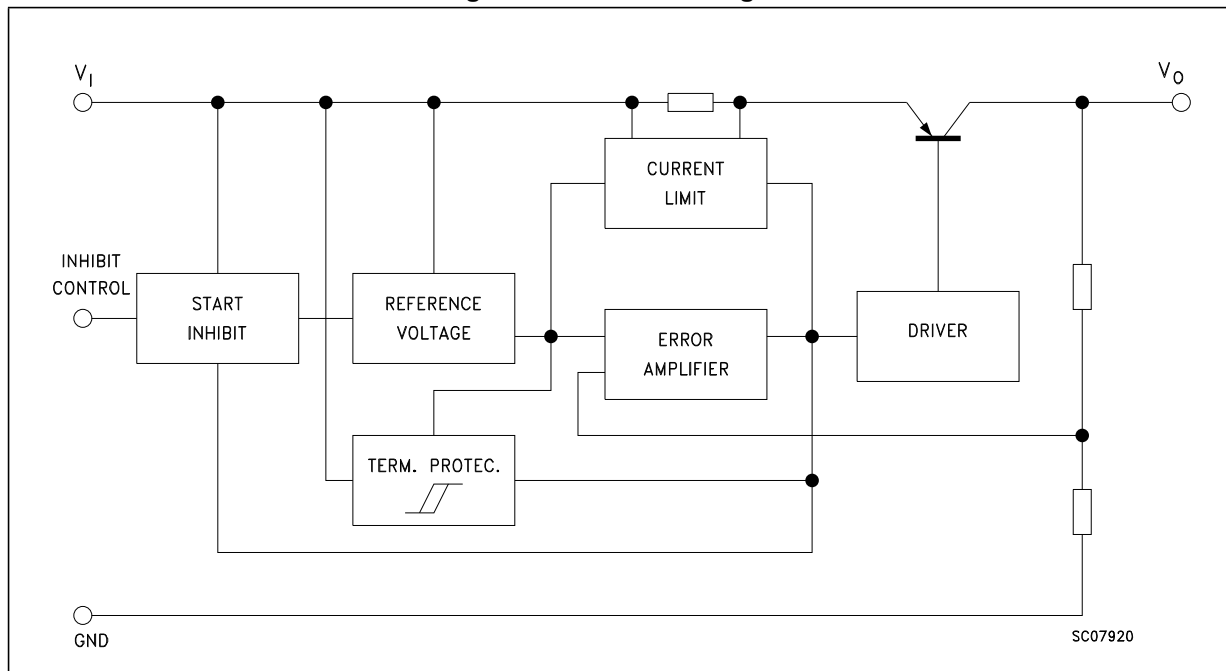

## 2 Pin configuration

Figure 2. Pin connections (top view)

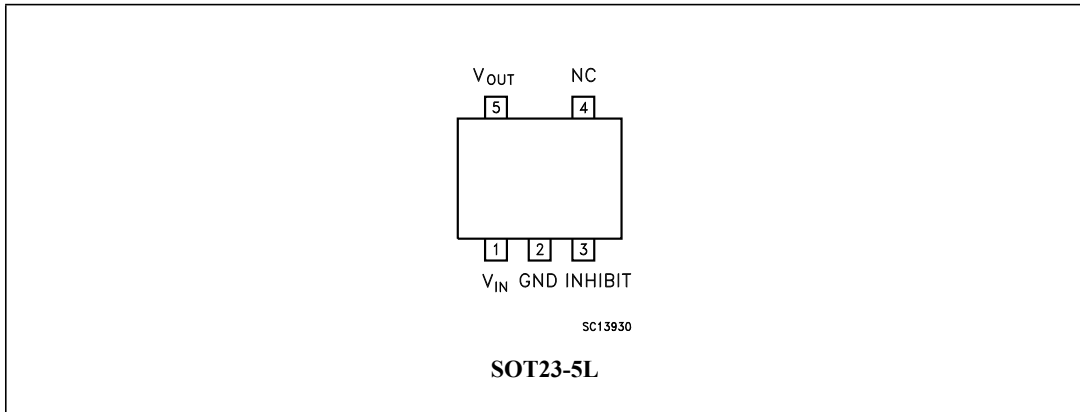

Table 2. Pin description

Pin n°	Symbol	Name and function
1	$V_{IN}$	Input port
2	GND	Ground pin
3	INHIBIT	Control switch ON/OFF. Inhibit is not internally pulled up; it cannot be left floating. It disables the device when connected to GND or to a positive voltage less than 0.18 V
4	NC	Not connected
5	$V_{OUT}$	Output port

Table 3. Thermal data

Symbol	Parameter	Value	Unit
$R_{thJC}$	Thermal resistance junction-case	81	°C/W
$R_{thJA}$	Thermal resistance junction-ambient	255	°C/W

### 3 Maximum ratings

**Table 4. Absolute maximum ratings**

Symbol	Parameter	Value	Unit
$V_I$	DC input voltage	-0.3 to 16	V
$V_{INH}$	INHIBIT input voltage	-0.3 to 16	V
$I_O$	Output current	Internally limited	
$P_D$	Power dissipation	Internally limited	
$T_{STG}$	Storage temperature range	-55 to 150	°C
$T_{OP}$	Operating junction temperature range	-40 to 125	°C

*Note: Absolute maximum ratings are those values beyond which damage to the device may occur. Functional operation under these conditions is not implied.*

## 4 Typical application

Figure 3. Application circuit

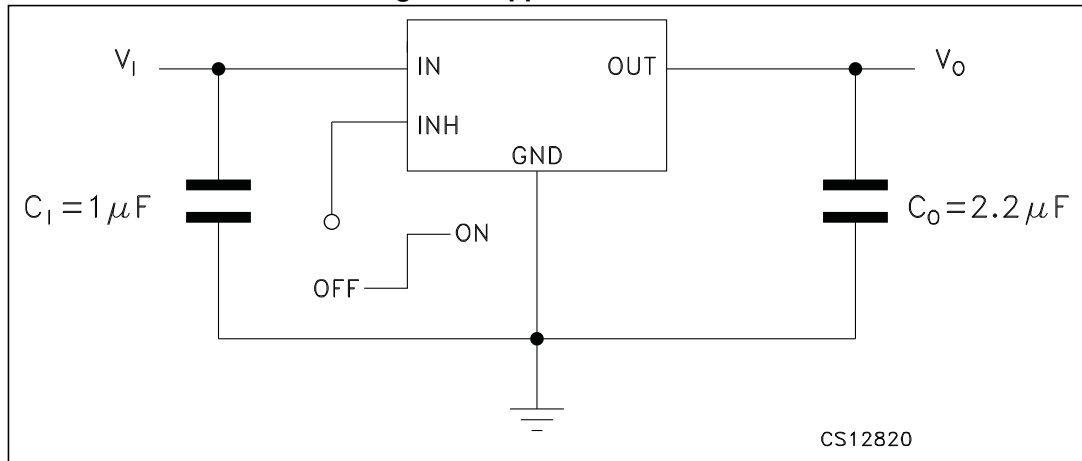

**Note:** *The inhibit pin is not internally pulled up, therefore it must not be left floating. It disables the device when connected to GND or to a positive voltage less than 0.18 V.*

## 5 Electrical characteristics

( $T_J = 25\text{ }^\circ\text{C}$ ,  $V_I = V_{O(NOM)} + 1\text{ V}$ ,  $C_I = 1\text{ }\mu\text{F}$ ,  $C_O = 2.2\text{ }\mu\text{F}$ ,  $I_O = 1\text{ mA}$ ,  $V_{INH} = 2\text{ V}$ , unless otherwise specified).

**Table 5. Electrical characteristics for LD2980ABM**

Symbol	Parameter	Test conditions	Min.	Typ.	Max.	Unit
$V_{OP}$	Operating input voltage		2.5		16	V
$V_O$	Output voltage	$I_O = 1\text{ mA}$	2.985	3	3.015	V
		$I_O = 1\text{ to }50\text{ mA}$	2.978		3.023	
		$I_O = 1\text{ to }50\text{ mA}$ , $T_J = -40\text{ to }125\text{ }^\circ\text{C}$	2.925		3.075	
$V_O$	Output voltage	$I_O = 1\text{ mA}$	3.284	3.3	3.317	V
		$I_O = 1\text{ to }50\text{ mA}$	3.275		3.325	
		$I_O = 1\text{ to }50\text{ mA}$ , $T_J = -40\text{ to }125\text{ }^\circ\text{C}$	3.217		3.383	
$\Delta V_O$	Line regulation	$V_{O(NOM)} + 1 < V_{IN} < 16\text{ V}$ , $I_O = 1\text{ mA}$		0.003	0.014	%V
		$T_J = -40\text{ to }125\text{ }^\circ\text{C}$			0.032	
$I_Q$	Quiescent current ON MODE	$I_O = 0$		80	100	$\mu\text{A}$
		$I_O = 0$ , $T_J = -40\text{ to }125\text{ }^\circ\text{C}$			150	
		$I_O = 1\text{ mA}$		100	150	
		$I_O = 1\text{ mA}$ , $T_J = -40\text{ to }125\text{ }^\circ\text{C}$			200	
		$I_O = 10\text{ mA}$		175	250	
		$I_O = 10\text{ mA}$ , $T_J = -40\text{ to }125\text{ }^\circ\text{C}$			450	
		$I_O = 50\text{ mA}$		500	700	
	OFF MODE	$V_{INH} < 0.18\text{ V}$		0		
		$V_{INH} < 0.18\text{ V}$ , $T_J = -40\text{ to }125\text{ }^\circ\text{C}$			1	
$V_{DROP}$	Dropout voltage <sup>(1)</sup>	$I_O = 0$		1	3	mV
		$I_O = 0$ , $T_J = -40\text{ to }125\text{ }^\circ\text{C}$			5	
		$I_O = 1\text{ mA}$		7	10	
		$I_O = 1\text{ mA}$ , $T_J = -40\text{ to }125\text{ }^\circ\text{C}$			15	
		$I_O = 10\text{ mA}$		40	60	
		$I_O = 10\text{ mA}$ , $T_J = -40\text{ to }125\text{ }^\circ\text{C}$			90	
		$I_O = 50\text{ mA}$		120	150	
		$I_O = 50\text{ mA}$ , $T_J = -40\text{ to }125\text{ }^\circ\text{C}$			225	
$I_{SC}$	Short circuit current	$R_L = 0$		150		mA
SVR	Supply voltage rejection	$C_O = 10\text{ }\mu\text{F}$ , $f = 1\text{ kHz}$		63		dB
$V_{INH}$	Inhibit input logic low	LOW = Output OFF, $T_J = -40\text{ to }125\text{ }^\circ\text{C}$		0.8	0.18	V

Table 5. Electrical characteristics for LD2980ABM (continued)

Symbol	Parameter	Test conditions	Min.	Typ.	Max.	Unit
$V_{INL}$	Inhibit input logic high	HIGH = Output ON, $T_J = -40$ to $125^\circ\text{C}$	1.6	1.3		V
$I_{INH}$	Inhibit input current	$V_{INH} = 0$ V, $T_J = -40$ to $125^\circ\text{C}$		0	-1	$\mu\text{A}$
		$V_{INH} = 5$ V, $T_J = -40$ to $125^\circ\text{C}$		5	15	
$e_N$	Output noise voltage	$B_W = 300$ Hz to $50$ kHz, $C_O = 10$ $\mu\text{F}$		160		$\mu\text{V}_{\text{RMS}}$
$T_{\text{SHDN}}$	Thermal shutdown			170		$^\circ\text{C}$

1. For  $V_O < 2.5$  V dropout voltage can be calculated according to the minimum input voltage in full temperature range.



( $T_J = 25\text{ }^\circ\text{C}$ ,  $V_I = V_{O(NOM)} + 1\text{ V}$ ,  $C_I = 1\text{ }\mu\text{F}$ ,  $C_O = 2.2\text{ }\mu\text{F}$ ,  $I_O = 1\text{ mA}$ ,  $V_{INH} = 2\text{ V}$ , unless otherwise specified).

**Table 6. Electrical characteristics for LD2980CM**

Symbol	Parameter	Test conditions	Min.	Typ.	Max.	Unit
$V_{OP}$	Operating input voltage		2.5		16	V
$V_O$	Output voltage	$I_O = 1\text{ mA}$	1.782	1.8	1.818	V
		$I_O = 1\text{ to }50\text{ mA}$	1.773		1.827	
		$I_O = 1\text{ to }50\text{ mA}$ , $T_J = -40\text{ to }125\text{ }^\circ\text{C}$	1.737		1.863	
$V_O$	Output voltage	$I_O = 1\text{ mA}$	3.267	3.3	3.333	V
		$I_O = 1\text{ to }50\text{ mA}$	3.251		3.35	
		$I_O = 1\text{ to }50\text{ mA}$ , $T_J = -40\text{ to }125\text{ }^\circ\text{C}$	3.184		3.415	
$\Delta V_O$	Line regulation	$V_{O(NOM)} + 1 < V_{IN} < 16\text{ V}$ , $I_O = 1\text{ mA}$		0.003	0.014	%V
		$T_J = -40\text{ to }125\text{ }^\circ\text{C}$			0.032	
$I_Q$	Quiescent current ON MODE	$I_O = 0$		80	100	$\mu\text{A}$
		$I_O = 0$ , $T_J = -40\text{ to }125\text{ }^\circ\text{C}$			150	
		$I_O = 1\text{ mA}$		100	150	
		$I_O = 1\text{ mA}$ , $T_J = -40\text{ to }125\text{ }^\circ\text{C}$			200	
		$I_O = 10\text{ mA}$		175	250	
		$I_O = 10\text{ mA}$ , $T_J = -40\text{ to }125\text{ }^\circ\text{C}$			450	
		$I_O = 50\text{ mA}$		500	700	
		$I_O = 50\text{ mA}$ , $T_J = -40\text{ to }125\text{ }^\circ\text{C}$			1200	
	OFF MODE	$V_{INH} < 0.18\text{ V}$		0		
		$V_{INH} < 0.18\text{ V}$ , $T_J = -40\text{ to }125\text{ }^\circ\text{C}$			1	
$V_{DROP}$	Dropout voltage <sup>(1)</sup>	$I_O = 0$		1	3	mV
		$I_O = 0$ , $T_J = -40\text{ to }125\text{ }^\circ\text{C}$			5	
		$I_O = 1\text{ mA}$		7	10	
		$I_O = 1\text{ mA}$ , $T_J = -40\text{ to }125\text{ }^\circ\text{C}$			15	
		$I_O = 10\text{ mA}$		40	60	
		$I_O = 10\text{ mA}$ , $T_J = -40\text{ to }125\text{ }^\circ\text{C}$			90	
		$I_O = 50\text{ mA}$		120	150	
		$I_O = 50\text{ mA}$ , $T_J = -40\text{ to }125\text{ }^\circ\text{C}$			225	
$I_{SC}$	Short circuit current	$R_L = 0$		150		mA
SVR	Supply voltage rejection	$C_O = 10\text{ }\mu\text{F}$ , $f = 1\text{ kHz}$		63		dB
$V_{INH}$	Inhibit input logic low	LOW = Output OFF, $T_J = -40\text{ to }125\text{ }^\circ\text{C}$		0.8	0.18	V
$V_{INL}$	Inhibit input logic high	HIGH = Output ON, $T_J = -40\text{ to }125\text{ }^\circ\text{C}$	1.6	1.3		V

Table 6. Electrical characteristics for LD2980CM (continued)

Symbol	Parameter	Test conditions	Min.	Typ.	Max.	Unit
$I_{INH}$	Inhibit input current	$V_{INH} = 0 \text{ V}$ , $T_J = -40 \text{ to } 125^\circ\text{C}$		0	-1	$\mu\text{F}$
		$V_{INH} = 5 \text{ V}$ , $T_J = -40 \text{ to } 125^\circ\text{C}$		5	15	
$e_N$	Output noise voltage	$B_W = 300 \text{ Hz to } 50 \text{ kHz}$ , $C_O = 10 \mu\text{F}$		160		$\mu\text{V}_{\text{RMS}}$
$T_{SHDN}$	Thermal shutdown			170		$^\circ\text{C}$

1. For  $V_O < 2.5 \text{ V}$  dropout voltage can be calculated according to the minimum input voltage in full temperature range.

## 6 Typical performance characteristics

( $T_J = 25\text{ }^\circ\text{C}$ ,  $V_I = V_{O(NOM)} + 1\text{ V}$ ,  $C_I = 1\text{ }\mu\text{F}$ ,  $C_O = 2.2\text{ }\mu\text{F}$ ,  $V_{INH} = 2\text{ V}$ , unless otherwise specified)

Figure 4. Output voltage vs. temperature

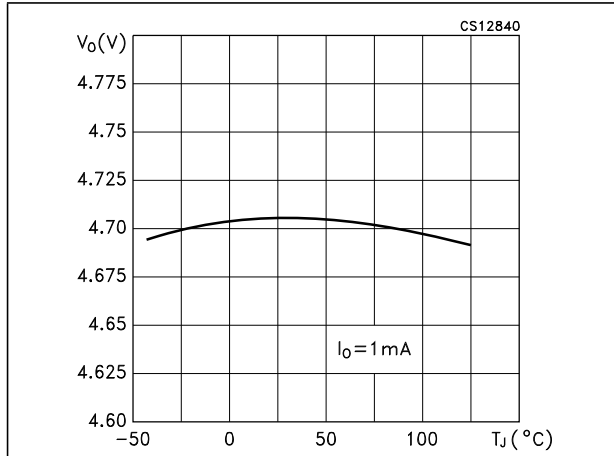

Figure 5. Output voltage vs. temperature

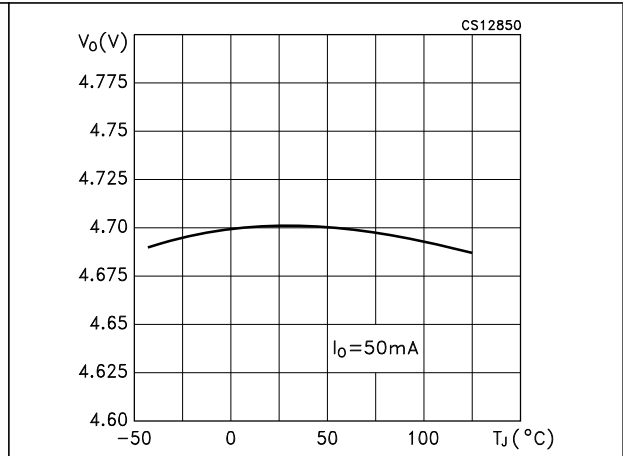

Figure 6. Line regulation vs. temperature

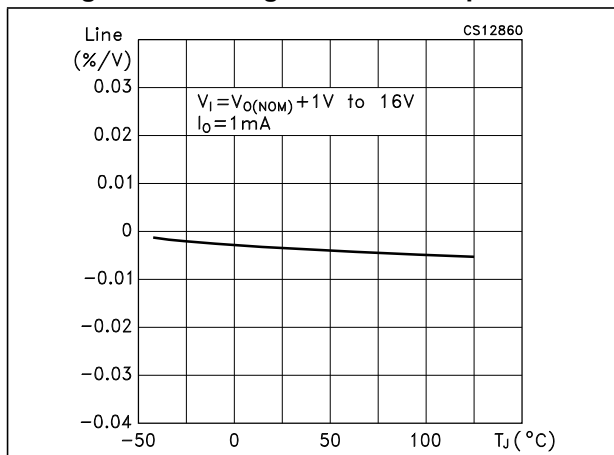

Figure 7. Load regulation vs. temperature

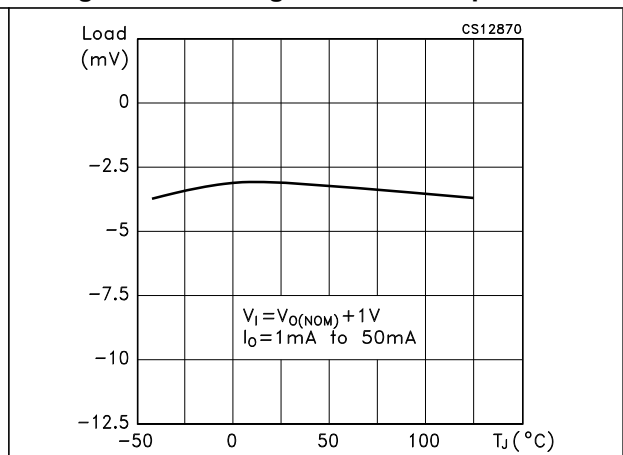

Figure 8. Dropout voltage vs. temperature

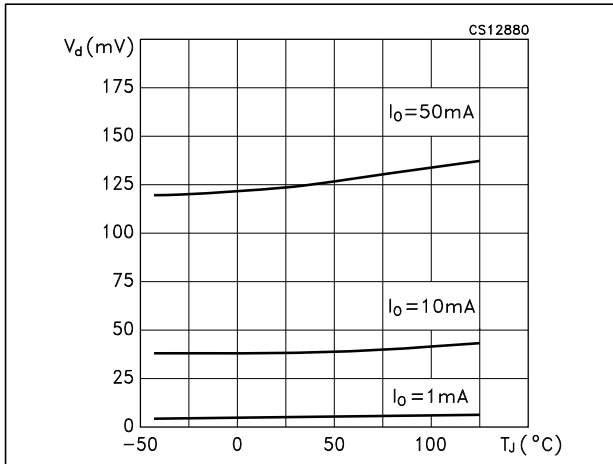

Figure 9. Quiescent current vs. temperature

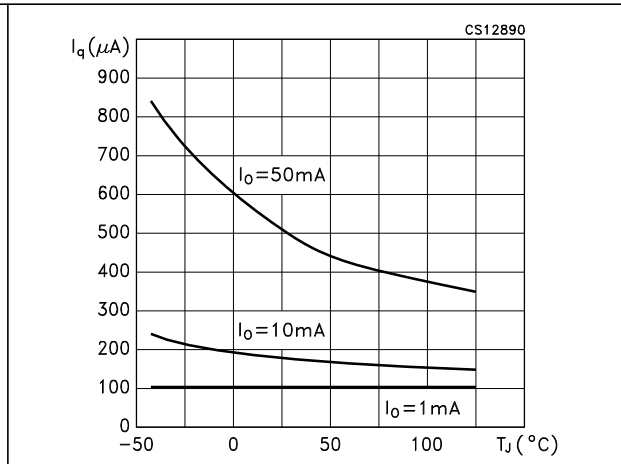

Figure 10. Quiescent current vs. output current

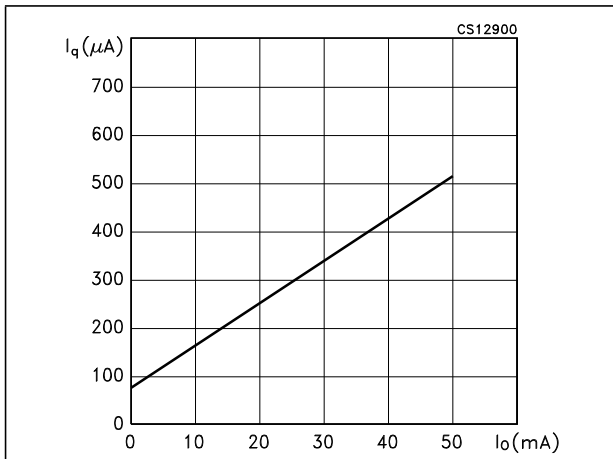

Figure 11. Off mode quiescent current vs. temperature

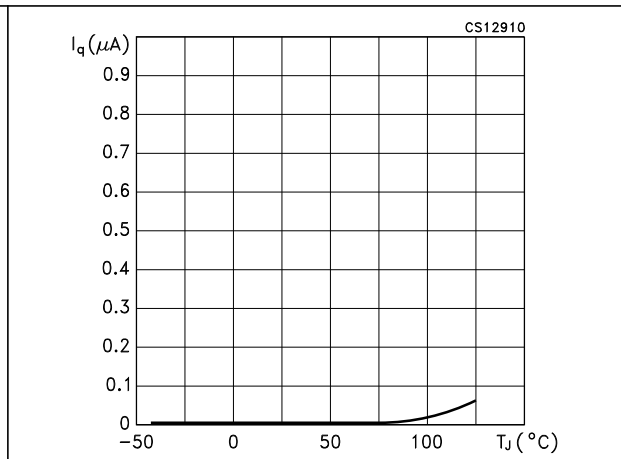

Figure 12. Quiescent current vs. input voltage

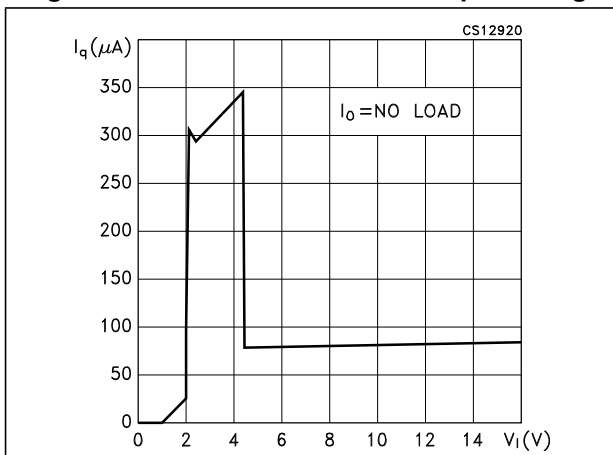

Figure 13. Dropout voltage vs. output current

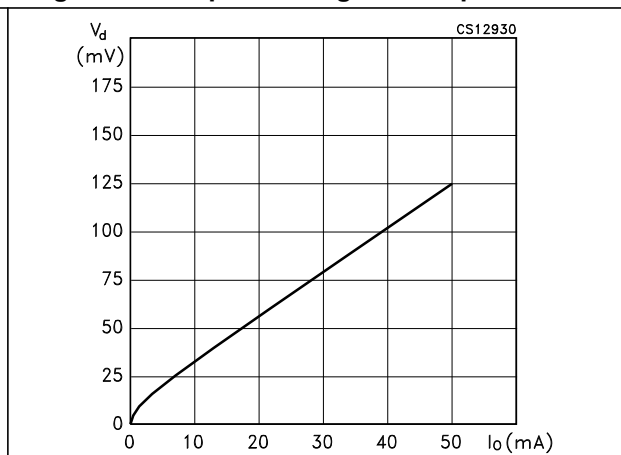

Figure 14. Inhibit input current vs. temperature

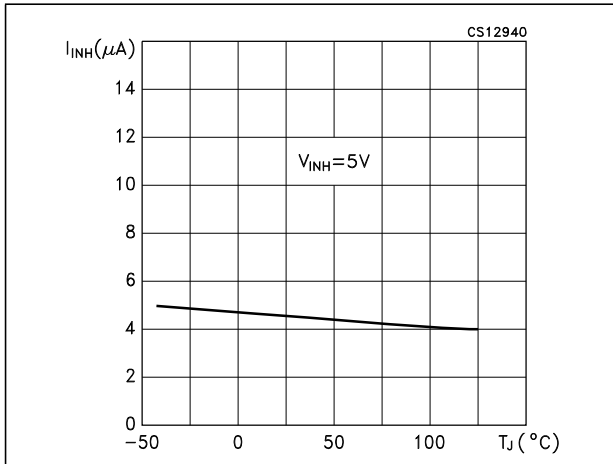

Figure 15. Inhibit voltage vs. temperature

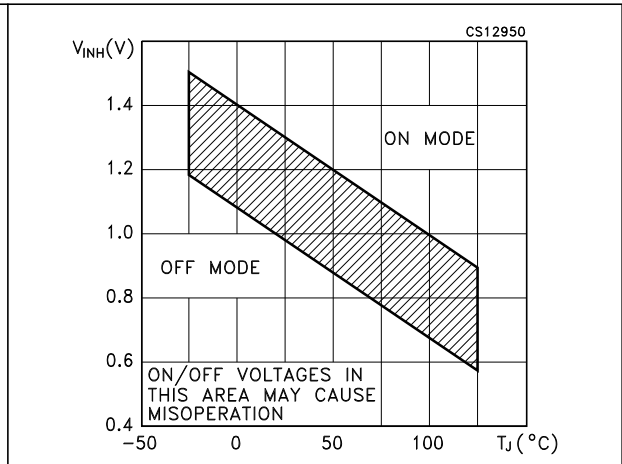

Figure 16. Supply voltage rejection vs. frequency

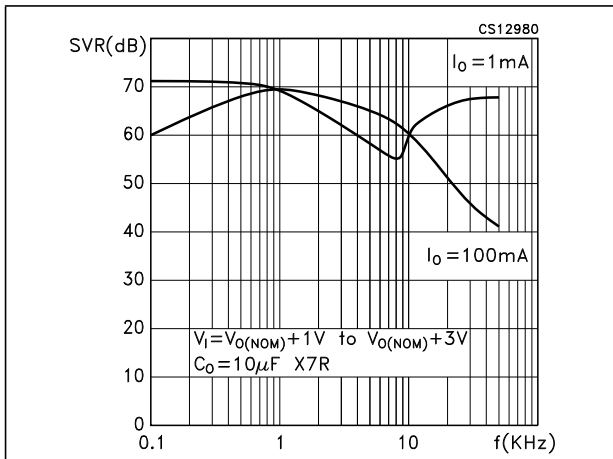

Figure 17. Noise voltage vs. frequency

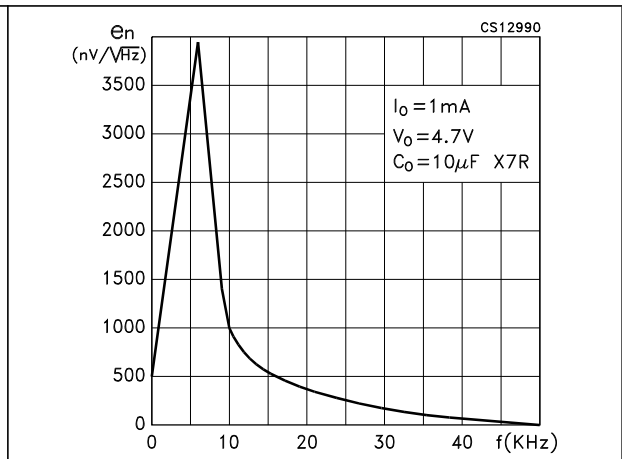

Figure 18. Best case: highest output version

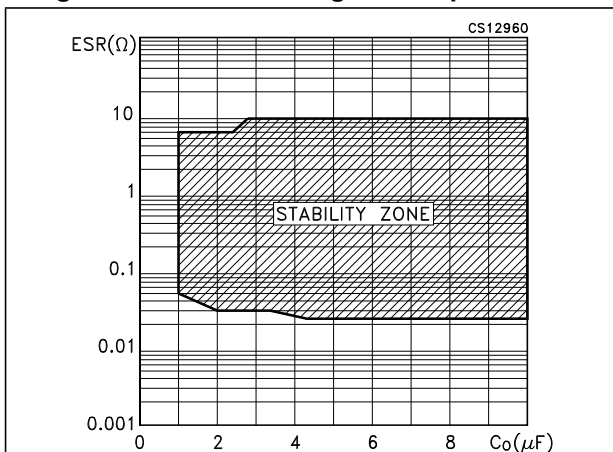

Figure 19. Worst case: lowest output version

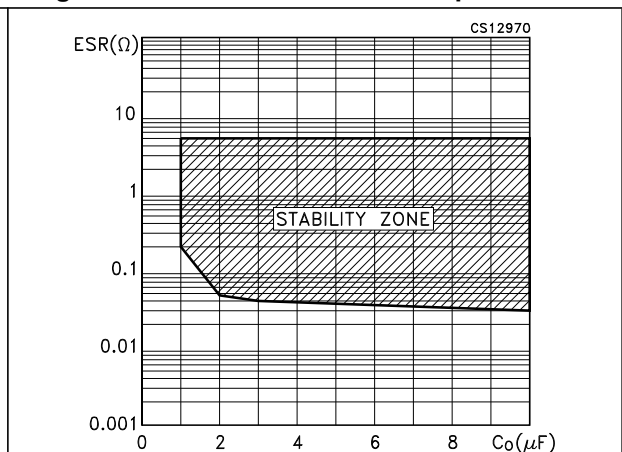

Figure 20. Load transient response

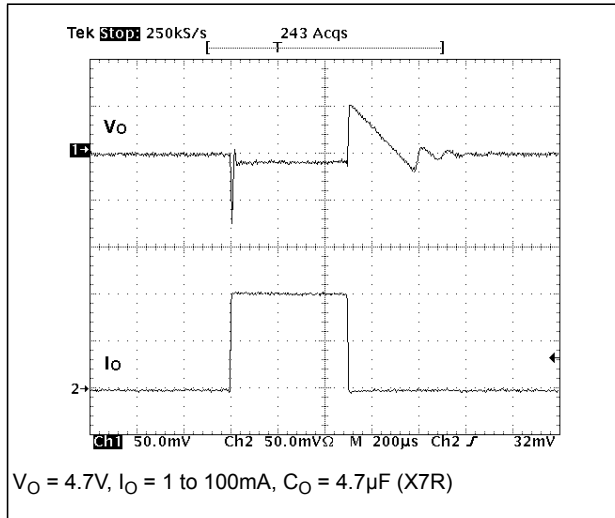
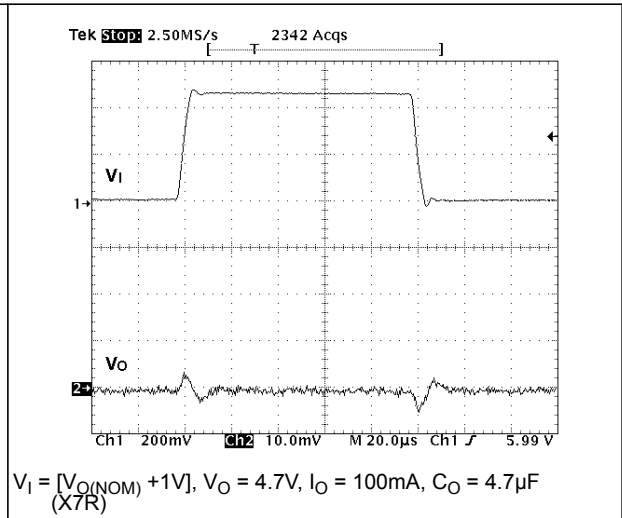

Figure 21. Line transient response



## 7 Application notes

### 7.1 External capacitors

Like any low-dropout regulator, the LD2980 requires external capacitors for regulator stability. This capacitor must be selected to meet the requirements of minimum capacitance and equivalent series resistance (please refer to [Figure 18](#) and [Figure 19](#)). We suggest to solder input and output capacitors as close as possible to the relative pins.

### 7.2 Input capacitor

An input capacitor whose value is 1  $\mu\text{F}$  is required with the LD2980 (amount of capacitance can be increased without limit). This capacitor must be located a distance of not more than 0.5" from the input pin of the device and returned to a clean analog ground. Any good quality ceramic, tantalum or film capacitors can be used for this capacitor.

### 7.3 Output capacitor

The LD2980 is designed specifically to work with ceramic output capacitors. It may also be possible to use Tantalum capacitors, but these are not as attractive for reasons of size and cost. The output capacitor must meet both the requirement for minimum amount of capacitance and ESR (equivalent series resistance) value. [Figure 18](#) and [Figure 19](#) show the allowable ESR range as a function of the output capacitance. These curves represent the stability region over the full temperature and  $I_O$  range. Due to the different loop gain, the stability improves for higher output versions and so the recommended minimum output capacitor value, if low ESR ceramic type is used, is 1  $\mu\text{F}$  for output voltages equal to or greater than 3.8 V, 2.2  $\mu\text{F}$  for output voltages from 2.85 to 3.3 V, and 3.3  $\mu\text{F}$  for the other versions. However, if an output capacitor lower than the recommendation is used, it's possible to stabilize the regulator by adding a resistor in series to the capacitor (see [Figure 18](#) and [Figure 19](#) to choose the right value according to the version used and taking into account that the ESR of ceramic capacitors has been measured @ 100 kHz).

### 7.4 Important

The output capacitor must maintain its ESR in the stable region over the full operating temperature to assure stability. Also, capacitor tolerance and variation with temperature must be considered to assure the minimum amount of capacitance is provided at all times. This capacitor should be located not more than 0.5" from the output pin of the device and returned to a clean analog ground.

### 7.5 Inhibit input operation

The inhibit pin can be used to turn OFF the regulator when pulled low, so drastically reducing the current consumption down to less than 1  $\mu\text{A}$ . When the inhibit feature is not used, this pin must be tied to  $V_I$  to keep the regulator output ON at all times. To assure proper operation, the signal source used to drive the inhibit pin must be able to swing above

and below the specified thresholds listed in the electrical characteristics section under  $V_{IH}$   $V_{IL}$ . Any slew rate can be used to drive the inhibit pin.

### 7.6 Reverse current

The power transistor used in the LD2980 does not have an inherent diode connected between the regulator input and output. If the output is forced above the input, no current will flow from the output to the input across the series pass transistor. When a  $V_{REV}$  voltage is applied on the output, the reverse current measured, according to the test circuit in [Figure 22](#), flows to GND across the two feedback resistors. This current typical value is 160  $\mu$ A.  $R_1$  and  $R_2$  resistors are implanted type; typical values are, respectively, 42.6 k $\Omega$  and 51.150 k $\Omega$ .

Figure 22. Reverse current test circuit

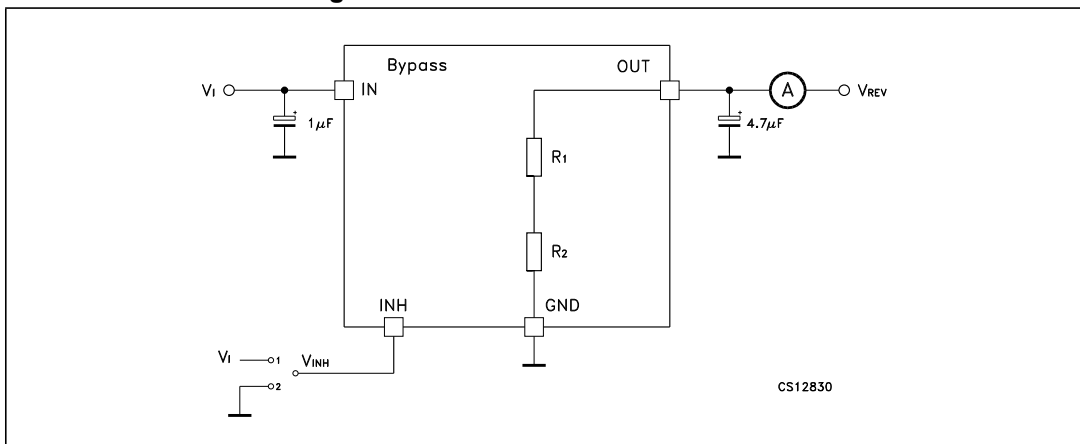



## 8 Package information

In order to meet environmental requirements, ST offers these devices in different grades of ECOPACK<sup>®</sup> packages, depending on their level of environmental compliance. ECOPACK<sup>®</sup> specifications, grade definitions and product status are available at: [www.st.com](http://www.st.com). ECOPACK<sup>®</sup> is an ST trademark.

### 8.1 SOT23-5L package information

Table 7. SOT23-5L mechanical data

Dim.	mm		
	Min.	Typ.	Max.
A	0.90		1.45
A1	0		0.15
A2	0.90		1.30
b	0.30		0.50
c	2.09		0.20
D		2.95	
E		1.60	
e		0.95	
H		2.80	
L	0.30		0.60
θ	0		8

Figure 23. SOT23-5L mechanical drawing

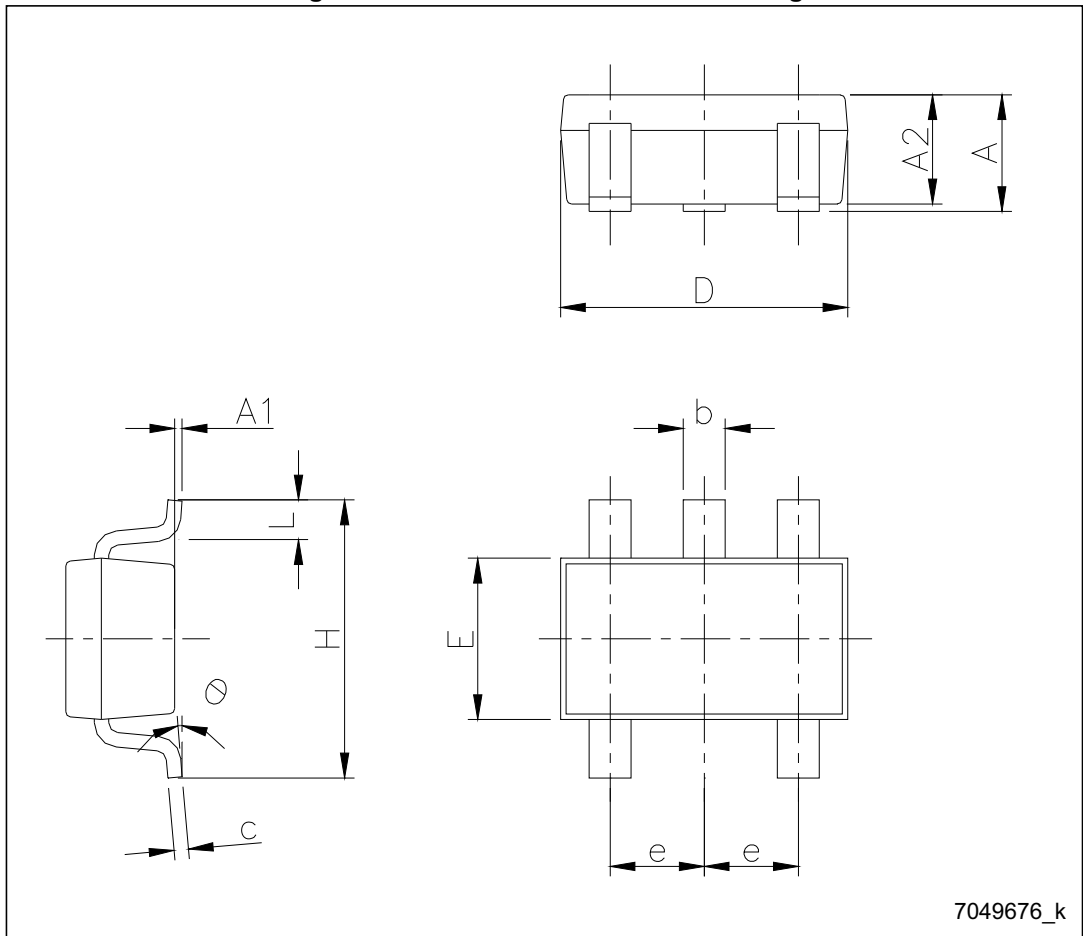

7049676\_k

Figure 24. SOT23-5L recommended footprint (dimensions in mm)

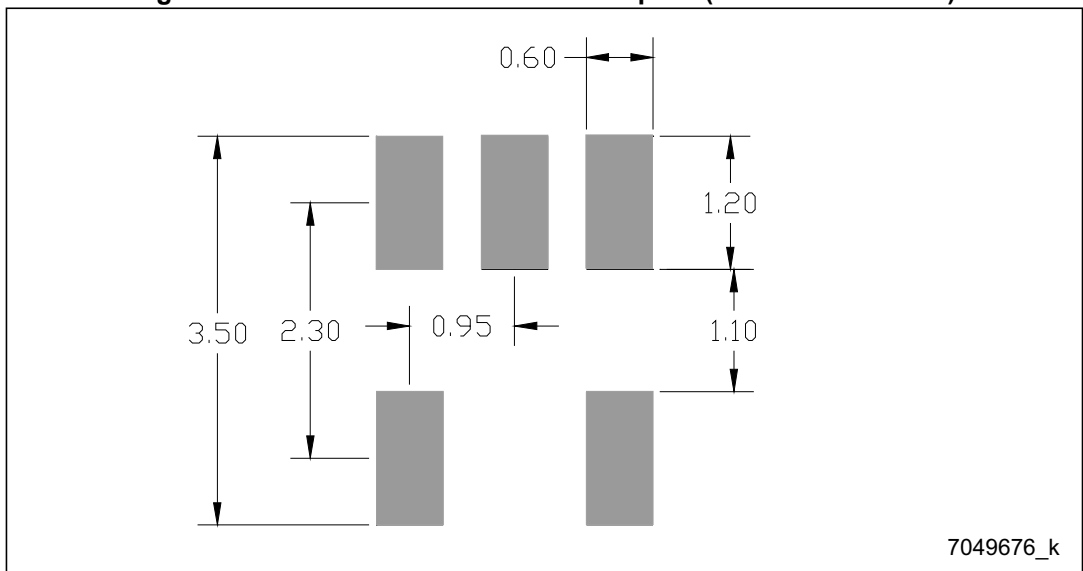

7049676\_k

## 9 Packaging information

### 9.1 SOT23-5L packaging information

Table 8. Tape and reel SOT23-5L mechanical data

Dim.	mm		
	Min.	Typ.	Max.
A			180
C	12.8	13.0	13.2
D	20.2		
N	60		
T			14.4
Ao	3.13	3.23	3.33
Bo	3.07	3.17	3.27
Ko	1.27	1.37	1.47
Po	3.9	4.0	4.1
P	3.9	4.0	4.1

Figure 25. Tape and reel SOT23-5L mechanical drawing

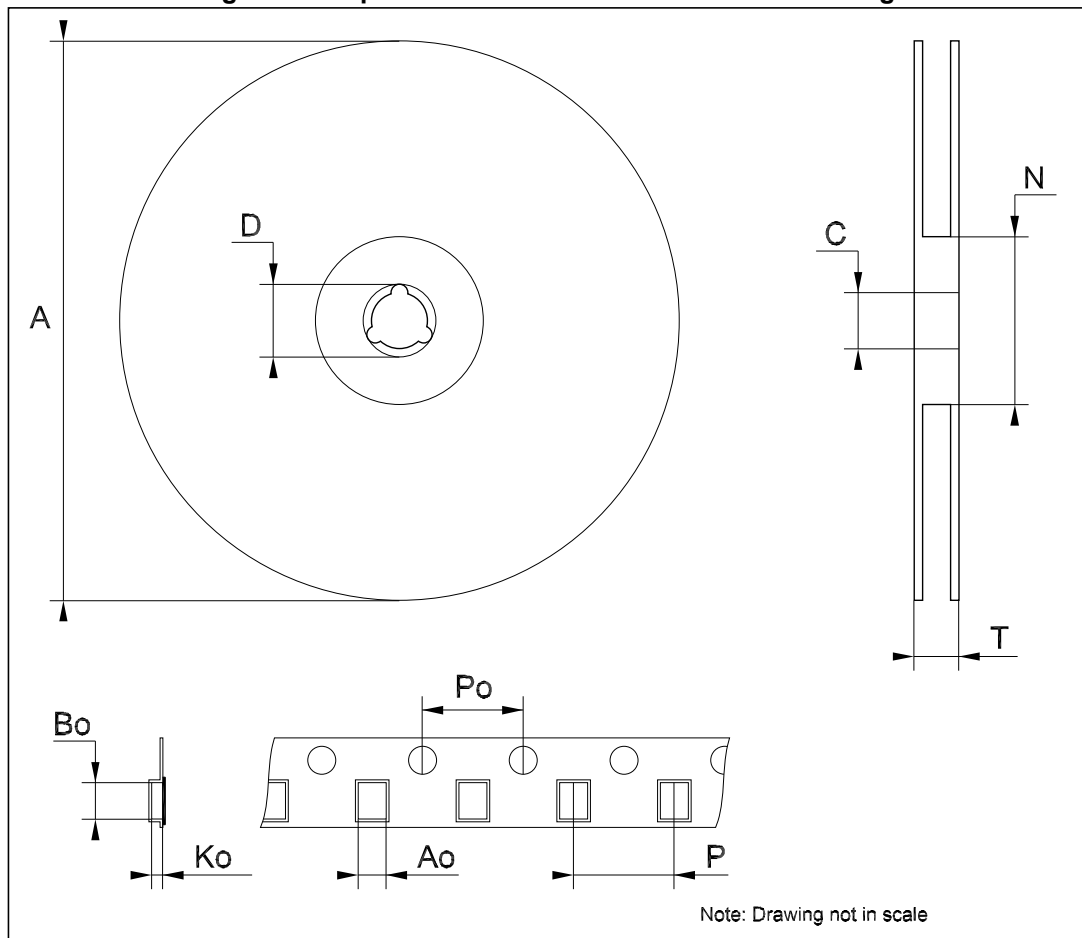

## 10 Revision history

**Table 9. Document revision history**

Date	Revision	Changes
03-Jul-2006	13	Order codes updated and new template.
13-Nov-2006	14	Add part number LD2980ABU18TR.
06-Sep-2007	15	Add <i>Table 1 on page 1</i> .
14-Feb-2008	16	Modified: <i>Table 1 on page 1</i> .
11-Jul-2008	17	Modified: <i>Table 1 on page 1</i> .
06-Nov-2013	18	Document name changed from LD2980ABxx and LD2980Cxx to LD2980. Updated <i>Table 1: Device summary</i> , <i>Table 5: Electrical characteristics for LD2980ABM</i> , <i>Table 6: Electrical characteristics for LD2980CM</i> and <i>Section 8: Package information</i> . Added <i>Section 9: Packaging information</i> . Minor text changes in title, in features and description in cover page.
30-Aug-2017	19	Removed 5.0 V versions of device (updated <i>Features</i> , <i>Table 1: Device summary</i> , <i>Table 5: Electrical characteristics for LD2980ABM</i> , and <i>Table 6: Electrical characteristics for LD2980CM</i> ) Minor textual updates

**IMPORTANT NOTICE – PLEASE READ CAREFULLY**

STMicroelectronics NV and its subsidiaries (“ST”) reserve the right to make changes, corrections, enhancements, modifications, and improvements to ST products and/or to this document at any time without notice. Purchasers should obtain the latest relevant information on ST products before placing orders. ST products are sold pursuant to ST’s terms and conditions of sale in place at the time of order acknowledgement.

Purchasers are solely responsible for the choice, selection, and use of ST products and ST assumes no liability for application assistance or the design of Purchasers’ products.

No license, express or implied, to any intellectual property right is granted by ST herein.

Resale of ST products with provisions different from the information set forth herein shall void any warranty granted by ST for such product.

ST and the ST logo are trademarks of ST. All other product or service names are the property of their respective owners.

Information in this document supersedes and replaces information previously supplied in any prior versions of this document.

© 2017 STMicroelectronics – All rights reserved