

Tape and reel shipping media for STM8 and STM32 microcontrollers in FPN packages

Introduction

FPN packages can be supplied in tape and reel shipping media.

The reels have a 13" typical diameter.

The types of reel used are in plastic either anti static or conductive, with a black conductive cavity tape. The cover tape is transparent anti static or conductive.

The devices are positioned in the cavities with the identifying pin (normally Pin "1") on the same side as the sprocket holes in the tape.

STMicroelectronics tape and reels are compliant with EIA 481 and IEC 60286-3 standard specifications.

Table 1 lists the FPN packages available for STM8 and STM32 microcontrollers, as well as the corresponding shipping media.

Table 1. FPN packages available in tape and reel packing

Package	Description	Package code	Reel diameter	Tape width	Tape pitch
FPN 2X3	UFDFPN 8 leads, 2x3x0.6 mm, 0.5 mm pitch	ZW	13"	8 mm	4 mm
				12 mm	4 mm
FPN 3X3	UFQFPN 20 leads, 3x3x0.6 mm, 0.5 mm pitch	A0A5		12 mm	8 mm
FPN 4X4	UFQFPN 28 leads, 4x4x0.55 mm, 0.5 mm pitch	A0B0			
FPN 5X5	VFQFPN 32 leads, 5x5x1.0 mm, 0.5 mm pitch	42			
FPN 5X5	UFQFPN 32 leads, 5x5x0.55 mm, 0.5 mm pitch	A0B8			
FPN 5X5	VFQFPN 24 leads, 5x5x1.0 mm, 0.65 pitch	Y1			
FPN 6X5	VFQFPN 20 leads, 5x6 mm, 0.80 mm pitch	MY			
FPN 6X6	VFQFPN 40 leads, 6x6x1.0 mm, 0.5 mm pitch	ZF		16 mm	8 mm
FPN 6X6	VFQFPN 36 leads, 6x6x1.0 mm, 0.50 mm pitch	ZR			
FPN 7X7	UFQFPN 48 leads, 7x7x0.55pitch, 0.5 mm pitch	A0B9			
FPN 7X7	VFQFPN2 48 leads, 7x7x1.0 mm, 0.5 mm pitch	NU			
FPN 7X7	VFQFPN 48 leads, 7x7x1.0 mm, 0.5 mm pitch	V0			

Contents

1	Reel description	5
2	Leader and trailer tape specifications	7
3	Labeling	8
4	Device Orientation	9
5	Carrier tape mechanical dimensions	10
6	Bending radius requirements	12
7	Camber requirements	13
8	Revision history	14

List of tables

Table 1.	FPN packages available in tape and reel packing	1
Table 2.	Reel dimensions	6
Table 3.	Carrier tape constant dimensions	10
Table 4.	Carrier tape variable dimensions	11
Table 5.	Document revision history	14

List of figures

Figure 1.	Reel diagram	5
Figure 2.	Leader and trailer tape schematics.	7
Figure 3.	Labeling location on reel for carrier tape	8
Figure 4.	Device orientation on tape	9
Figure 5.	Embossed carrier tape	10
Figure 6.	Bending radius requirements	12
Figure 7.	Camber requirements	13

1 Reel description

Figure 1. Reel diagram

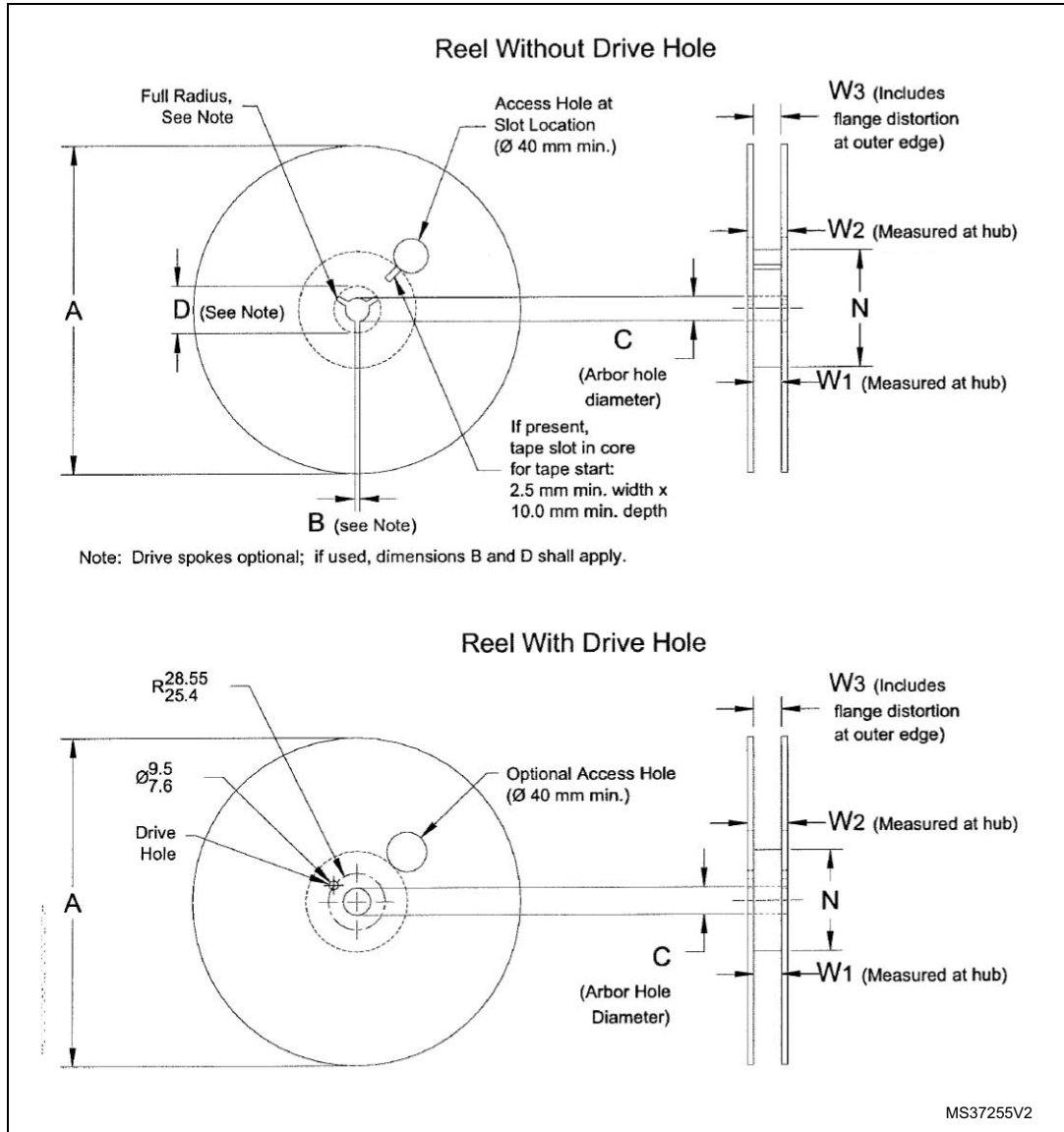

Table 2. Reel dimensions⁽¹⁾

Reel size (inch)	Tape size (mm)	A max. (mm)	Reeds without drive hole			Reeds with drive hole			N(mm)	W1(mm) ⁽²⁾	W2 max.(mm)
			B min. (mm)	C (mm)	D min.(mm)	B min.(mm)	C max.(mm)	D min.(mm)			
13	8	330	1.5	13.0+0.5/-0.2	20.2	NA	29.2	NA	100	8.4+1.5/-0	14.4
	12								100		
	16								178±5	16.4+2/-0	22.4
									100		

1. NA stands for "not applicable".

2. W1 is measured at the hub.

2 Leader and trailer tape specifications

The leader has a minimum width of 400 mm which includes at least 100 mm of carrier tape with empty cavities and sealed cover tape (see [Figure 2](#)). The leader tape is affixed to the last turn of carrier tape by using a transparent adhesive anti static or paper based tape of a width not higher than the one of the cover tape.

The trailer is a carrier tape which minimum width is 160 mm with empty cavities and sealed cover tape, as shown in [Figure 2](#). The trailer tape must be affixed to the reel by using the tape slot of the reel hub.

During the unwinding operation, the entire carrier tape must be easily released from the reel hub as the last portion of the tape unwinds from the reel without damaging the carrier tape and the remaining components in the cavities.

Figure 2. Leader and trailer tape schematics

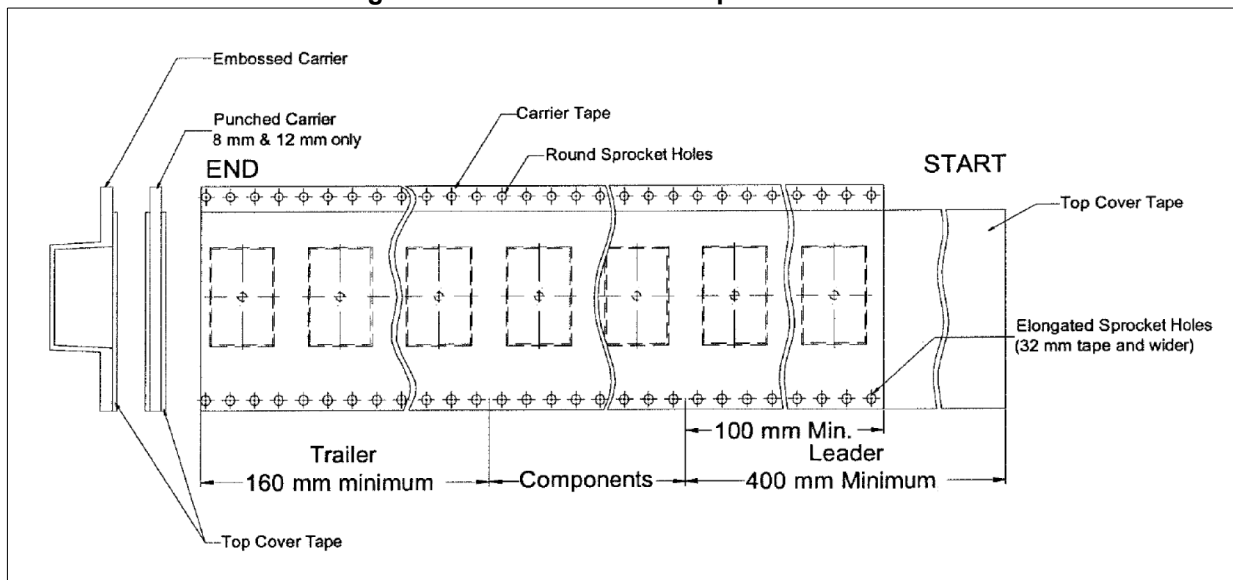

3 Labeling

STMicroelectronics “inner box” standard label is placed on each reel at the following locations:

- On the box that directly holds the reel
- On the damp proof bag if the units are dry packed
- On the reel itself

The label is attached to the flange that is facing the user when the tape is extracted from the reel at the top right (see [Figure 3](#)).

Figure 3. Labeling location on reel for carrier tape

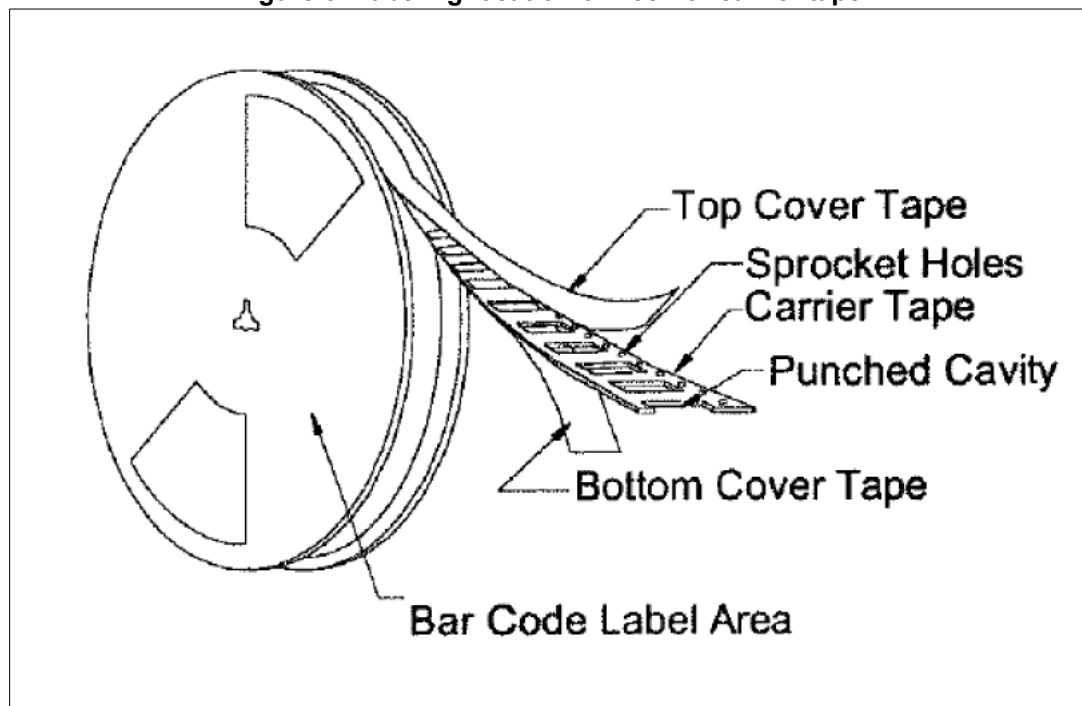

4 Device Orientation

The largest axis of the component outline is perpendicular to the tape length.

The device is positioned in the carrier tape cavity as shown in [Figure 4: Device orientation on tape](#). Pin 1 is located on the top right corner of the package.

Figure 4. Device orientation on tape

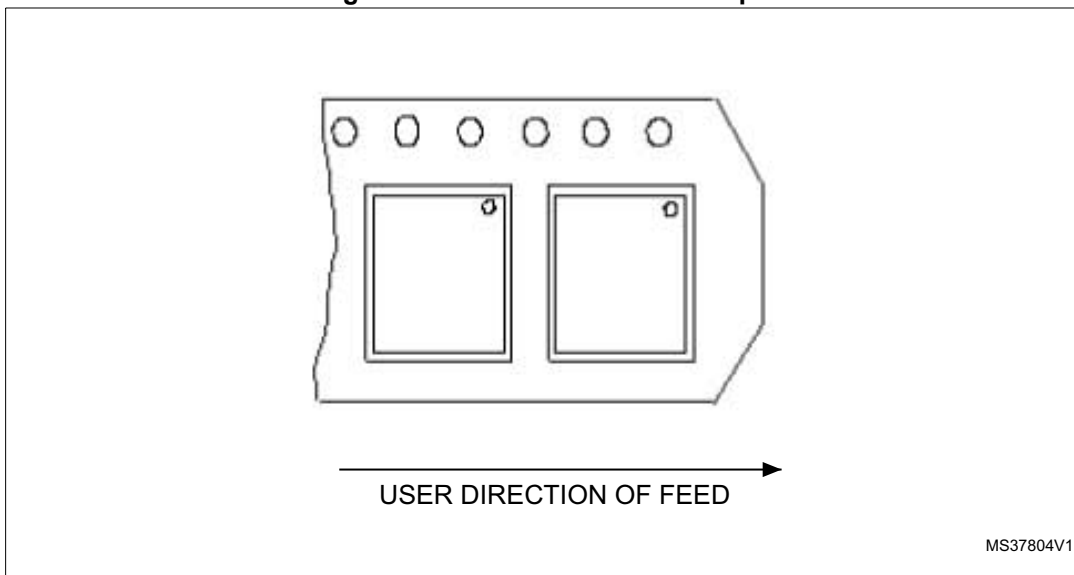

5 Carrier tape mechanical dimensions

Possible widths are 8, 12 and 16 mm (refer to [Table 1: FPN packages available in tape and reel packing](#)).

Figure 5. Embossed carrier tape

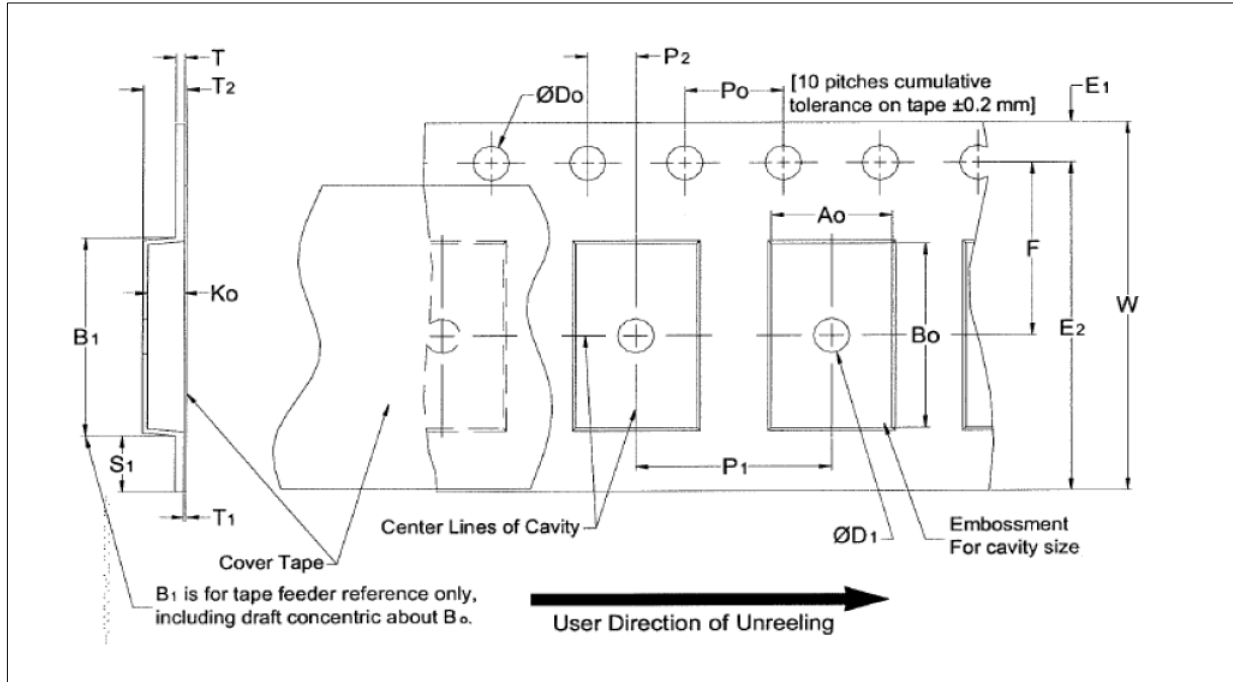

Table 3. Carrier tape constant dimensions

Tape width	D0	D1 min	E1	P0	P2	R ⁽¹⁾	S1	T max.	T1 max.	Unit
8 mm	1.5+0.1 /-0.0	1.0	1.75±0.1	4.0±0.1	2.0±0.05	25	0.6	0.6	0.1	mm
12 mm		1.5				30				
16 mm					2.0±0.1					

1. The maximum radius the tape with or without components can bend without damage is specified in [Section 6: Bending radius requirements](#).

Table 4. Carrier tape variable dimensions

Tape width	B1	E2	F	P1	T2 max.	W max.	A0, B0, K0	Unit
8 mm	4.35	6.25	3.5±0.05	4.0±0.10	2.5	8.3	See ⁽¹⁾	mm
12 mm	8.2	10.25	5.5±0.05	4.0±0.1 or 8.0±0.1	6.5	12.3		
16 mm	12.1	14.25	7.5±0.1	8.0±0.1 or 12.0±0.1	8.0	16.3		

1. The cavity defined by A0, B0 and K0 surrounds the component with sufficient clearance so that:
- The component does not protrude above the top surface of the carrier tape.
 - The component can be removed vertically from the cavity without mechanical restriction, after the top cover tape has been removed.
 - Rotation of the component is limited to 20° maximum for 12 mm tapes and to 10° maximum for 16 mm tapes.
 - Lateral movements of the component are restricted to 0.5 mm maximum for 12 mm tapes and to 1.0 mm maximum for 16 mm tapes.

6 Bending radius requirements

Figure 6. Bending radius requirements

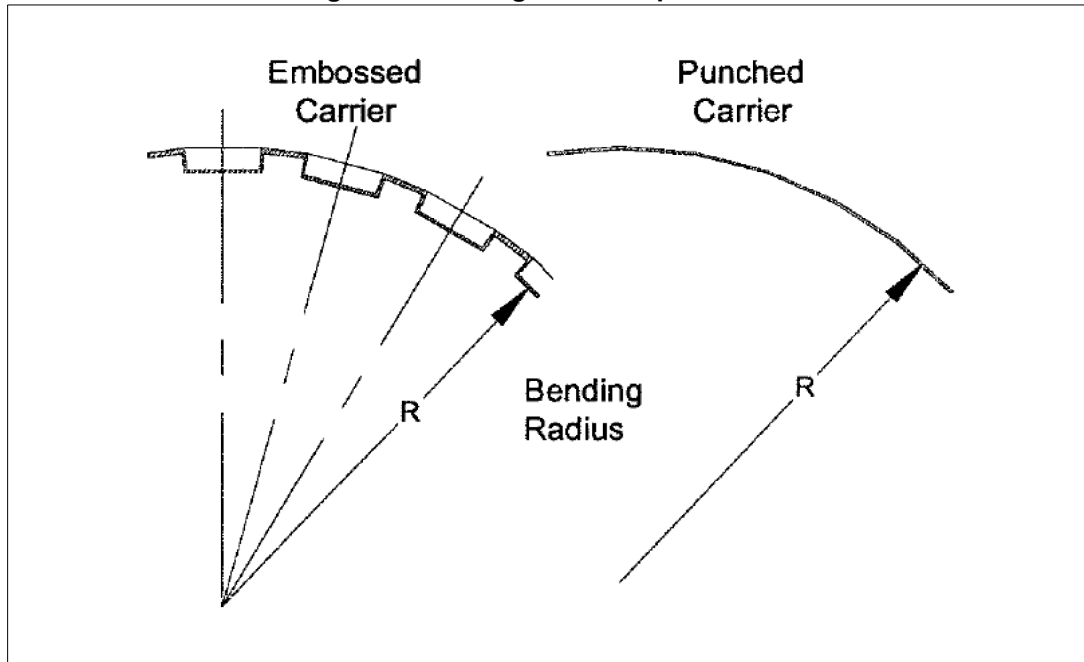

7 Camber requirements

Carrier camber should not exceed more than 1 mm in 250 mm of carrier tape length.

Figure 7. Camber requirements

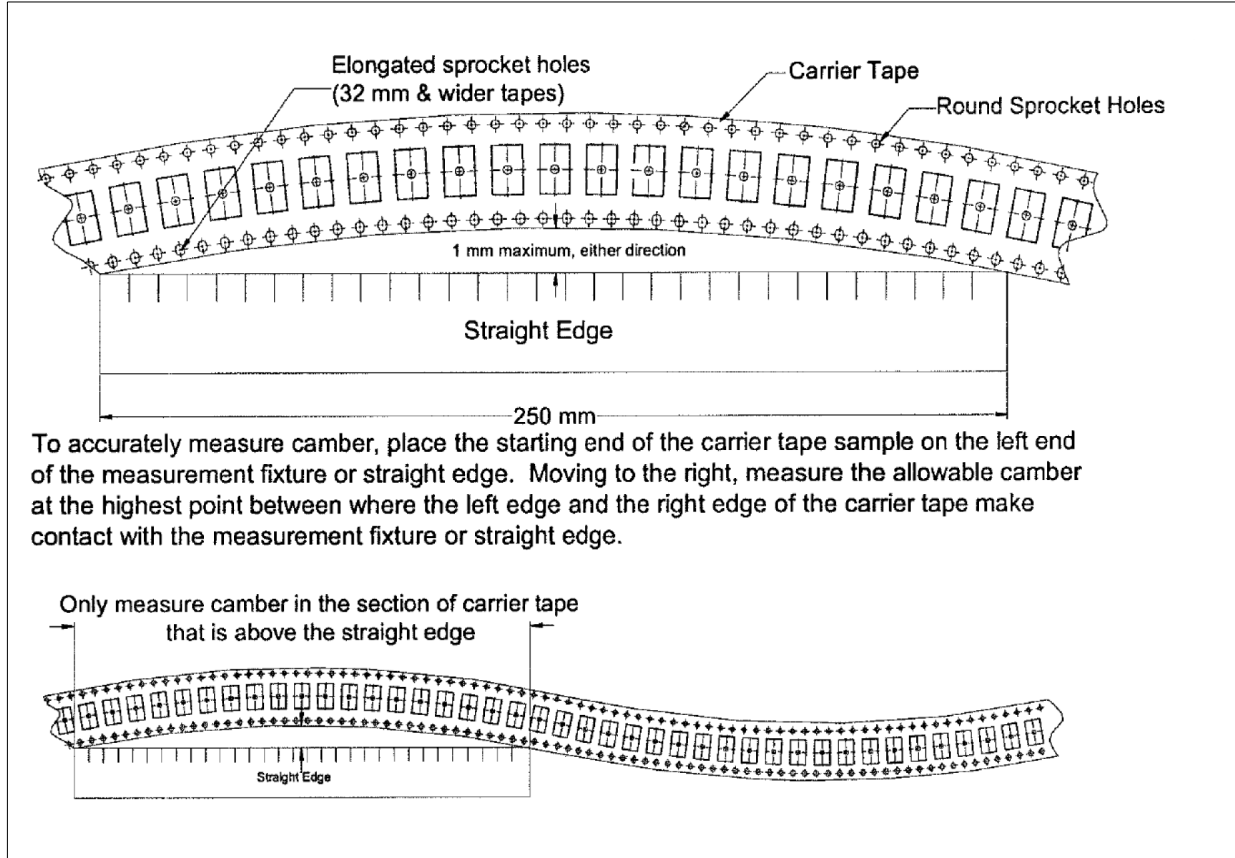

8 Revision history

Table 5. Document revision history

Date	Revision	Changes
19-Feb-2015	1	Initial release.
26-Mar-2015	2	Updated Figure 4: Device orientation on tape .
21-Apr-2015	3	Updated pin 1 location in Section 4: Device Orientation . Updated P1 dimension and note 1. in Table 4: Carrier tape variable dimensions .

IMPORTANT NOTICE – PLEASE READ CAREFULLY

STMicroelectronics NV and its subsidiaries ("ST") reserve the right to make changes, corrections, enhancements, modifications, and improvements to ST products and/or to this document at any time without notice. Purchasers should obtain the latest relevant information on ST products before placing orders. ST products are sold pursuant to ST's terms and conditions of sale in place at the time of order acknowledgement.

Purchasers are solely responsible for the choice, selection, and use of ST products and ST assumes no liability for application assistance or the design of Purchasers' products.

No license, express or implied, to any intellectual property right is granted by ST herein.

Resale of ST products with provisions different from the information set forth herein shall void any warranty granted by ST for such product.

ST and the ST logo are trademarks of ST. All other product or service names are the property of their respective owners.

Information in this document supersedes and replaces information previously supplied in any prior versions of this document.

© 2015 STMicroelectronics – All rights reserved

