



TDA7490SA

10W +10W Stereo Class-D Amplifier

Features

- FEATURES
- 10W + 10W CONTINUOUS OUTPUT POWER: $R_L = 8\Omega$ THD = 10%
- HIGH EFFICIENCY
- SINGLE SUPPLY AND SPLIT SUPPLY OPERATION
- POP NOISE FREE
- ST-BY AND MUTE FEATURES
- SHORT CIRCUIT PROTECTION
- THERMAL OVERLOAD PROTECTION
- EXTERNALLY SYNCHRONIZABLE



Description

The tda7490SA is a dual audio class-D amplifier assembled in CLIPWATT 19 package specially designed for high efficiency application mainly for TV, LCD TV and Home Stereo sets.

Order codes

Part number	Temp range, °C	Package	Packing
TDA7490SA	0 to 70	CLIPWATT 19	Tube

Contents

1	Typical application and pin description	3
1.1	typical application	3
1.2	pin description	3
1.3	thermal data	4
2	Electrical characteristics	5
3	PCB	9
3.1	PCB and component layout	9
4	Package information	11
5	Revision history	12

1 Typical application and pin description

1.1 typical application

Figure 1. typical application and test circuit for single and split supply

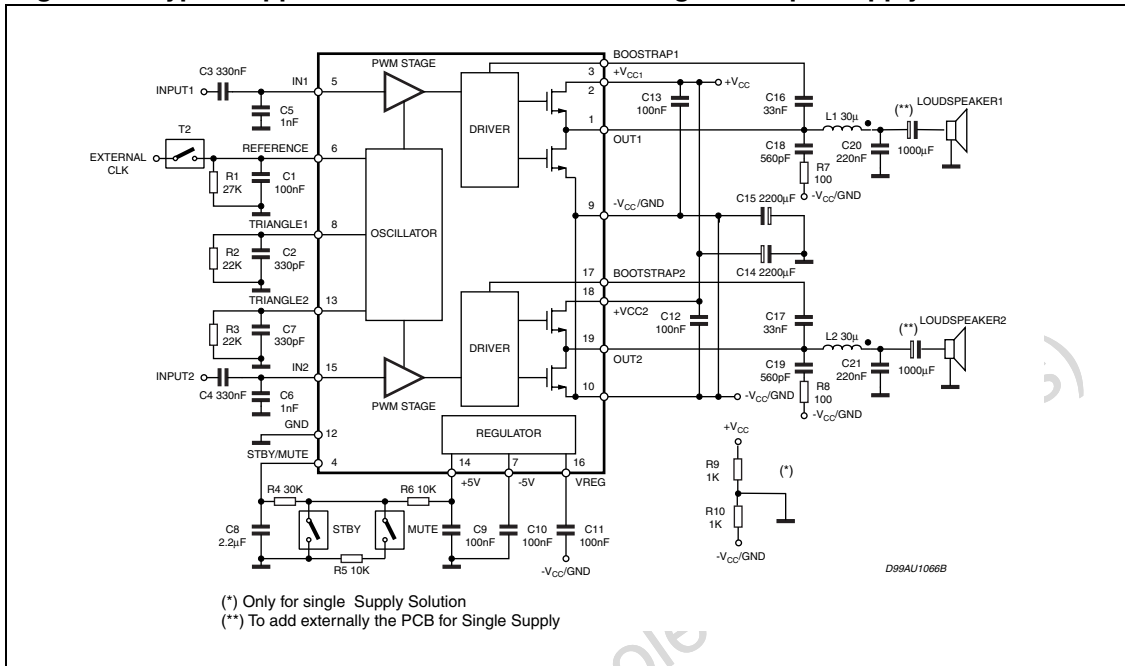

1.2 pin description

Figure 2. pin connection

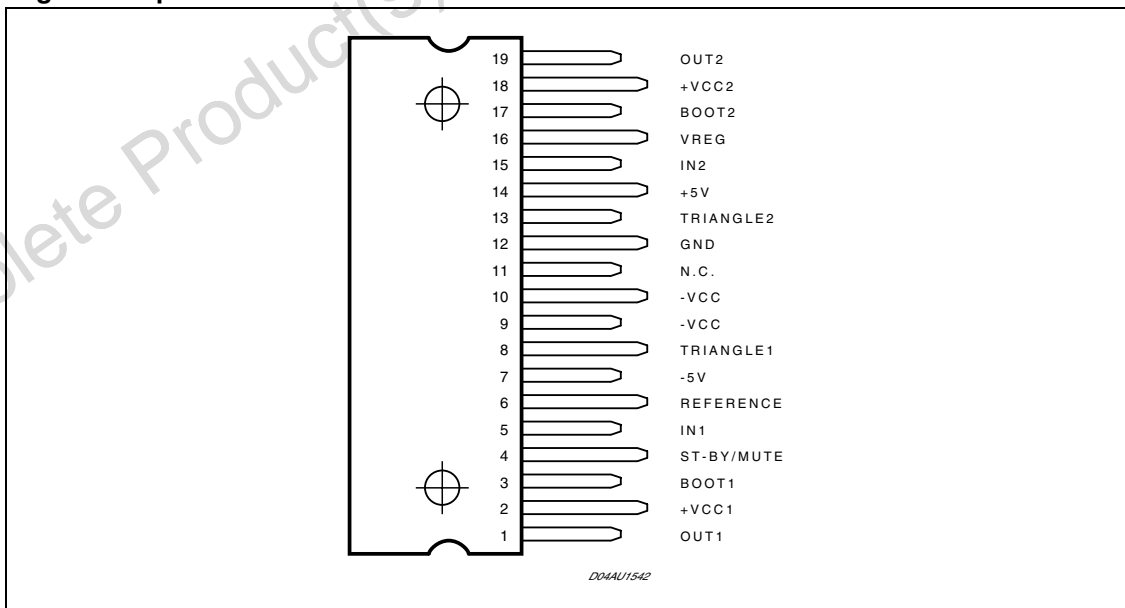

Table 1. pin description

N°	Pin	Function
1	OUT 1	Output CH1
2	+V _{CC1}	Positive Power Supply CH1
3	BOOT1	Bootstrap CH1
4	ST-BY/MUTE	State Pin
5	IN1	Input CH1
6	REFERENCE	Master Oscillator Setting Frequency
7	-5V	-5V Regulator
8	TRIANGLE 1	Triangular Waveform CH1
9	-V _{CC}	Negative Power Supply (Signal Ground)
10	-V _{cc}	Negative Power Supply (Power Ground) connected to tab
11	N.C.	
12	GND	Ground
13	TRIANGLE 2	Triangular Waveform CH2
14	+5V	+5V regulator
15	IN 2	Input CH2
16	V _{REG}	10V Regulator
17	BOOT 2	Bootstrap CH2
18	+V _{CC2}	Positive Power Supply CH2
19	OUT 2	Output CH2

1.3 thermal data

Table 2. thermal data

Symbol	Parameter	Test Condition	Typ.	Max.	Unit
R _{th j-case}	Thermal Resistance Junction-case		2	3	°C/W
R _{th j-amb}	Thermal Resistance Junction-ambient			48	°C/W

2 Electrical characteristics

Table 3. electrical characteristics (Refer to the test circuit, $V_{CC} = \pm 13.5V$; $R_L = 8\Omega$; Demod. filter $L = 33 \mu H$, $C = 220nF$; $f = 1KHz$; $R1 = 27k\Omega$; $T_{amb} = 25^\circ C$ unless otherwise specified.)

Symbol	Parameter	Test Condition	Min.	Typ.	Max.	Unit
V_S	Supply Range		± 7		± 15	V
I_q	Total Quiescent Current	$R_L = \infty$; no LC filter		60		mA
V_{OS}	Output Offset Voltage		-150		+150	mV
P_o	Output Power	THD = 10%		10		W
		THD = 1%		8.2		W
		$V_{CC} = \pm 10V$; $R_L = 4\Omega$		10		W
		THD = 10%		8		W
		THD = 1%		4		W
		$V_{CC} = \pm 6V$; $R_L = 4\Omega$		3		W
		THD = 10%				W
		THD = 1%				W
						W
P_D	Maximum Dissipated Power	$P_o = 10+10W$; THD = 10%			3.5	W
h	Efficiency ⁽¹⁾	$P_o = 10+10W$; $R_L = 8\Omega$		86		%
THD	Total Harmonic Distortion	$R_L = 8\Omega$; $P_o = 0.5W$		0.1		%
I_{max}	Overcurrent Protection Threshold	$R_L = 0$	2	2.5		A
T_j	Thermal Shut-down Junction Temperature			150		$^\circ C$
G_V	Closed Loop Gain			30		dB
ΔG_V	Gain Matching		-1		1	dB
e_N	Total Input Noise	A Curve $f = 20Hz$ to $22KHz$		7		μV
				12		μV
C_T	Cross Talk	$f = 1KHz$		t.b.d.		dB
R_i	Input Resistance			30		$k\Omega$
SVR	Supply Voltage Rejection	$f = 100Hz$; $V_r = 0.5$		60		dB
V_{rmax}	Overvoltage Protection Threshold		30			V
T_r, T_f	Rising and Falling Time			50		ns
$R_{DS(on)}$	Power Transistor on Resistance			0.3		W
F_{SW}	Switching Frequency	Internal Oscillator	180	200	220	KHz

Table 3. electrical characteristics (Refer to the test circuit, $V_{CC} = \pm 13.5V$; $R_L = 8\Omega$; Demod. filter $L = 33 \mu H$, $C = 220nF$; $f = 1KHz$; $R1 = 27k\Omega$; $T_{amb} = 25^\circ C$ unless otherwise specified.)

Symbol	Parameter	Test Condition	Min.	Typ.	Max.	Unit
F_{SWR}	Output Switching Frequency Range	with Internal Oscillator ⁽²⁾	140		250	KHz
		with external Oscillator ⁽³⁾	100		250	KHz
MUTE & STAND-BY FUNCTIONS						
V_{ST-BY}	Stand-by range		0		0.7	V
V_{MUTE}	Mute Range		1.7		2.5	V
V_{PLAY}	Play Range		4		5	V
A_{MUTE}	Mute Attenuation			60		dB
I_{qST-BY}	Quiescent Current @ Stand-by			1.5	2	mA

Note: 1 : $P_O =$ measured across the load using the following inductor: SUMIDA RCH-108-330K

2 : $F_{sw} = \frac{4810}{R1} + 23$ with $R1$ in $K\Omega$; F_{sw} in KHz

3 : $F_{sw} = F_{sw} = \left(\frac{1}{4}\right) \cdot F_{ext}$ with F_{ext} the frequency of the external oscillator

Figure 3. distortion vs output power

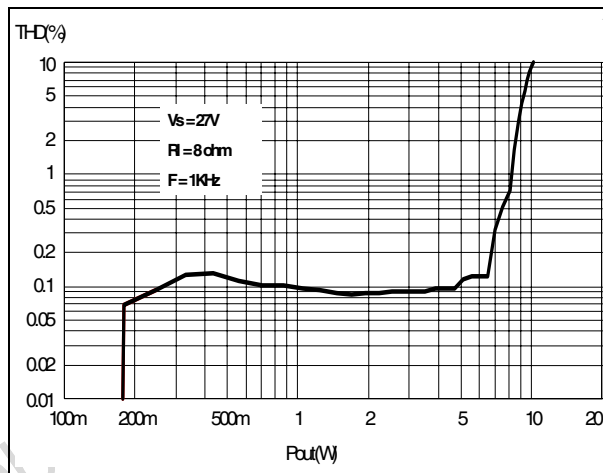

Figure 4. output Power vs Supply Voltage (single)

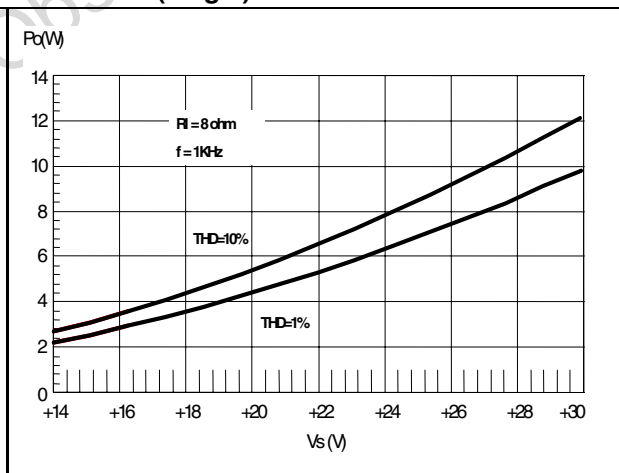

Figure 5. output power vs supply voltage (single)

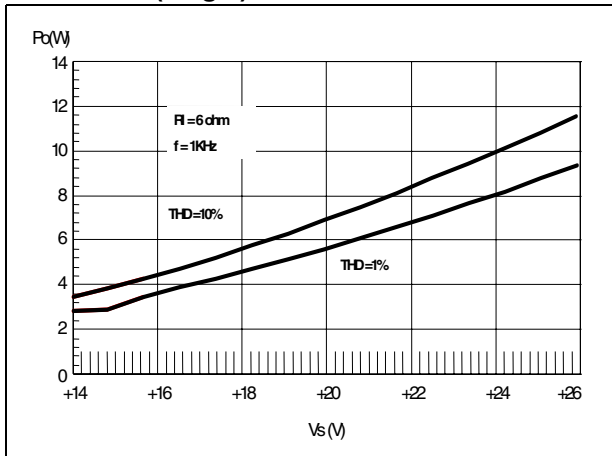

Figure 6. dissipated power vs output power

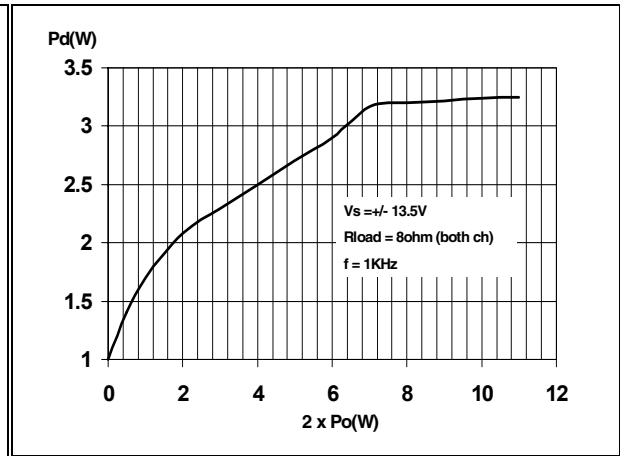

Figure 7. output power vs supply voltage (single)

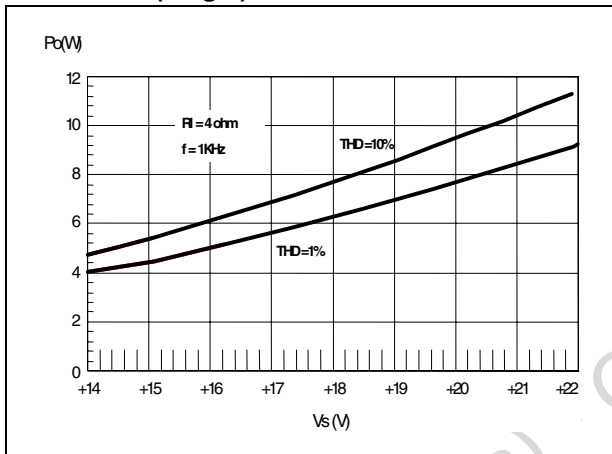

Figure 8. quiescent current vs supply voltage

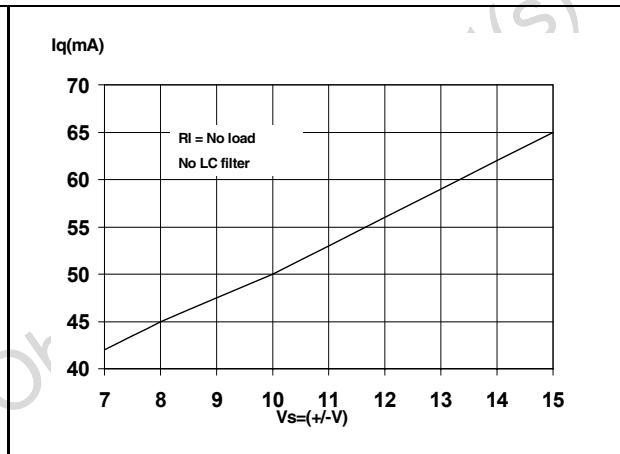

Figure 9. distortion vs output power

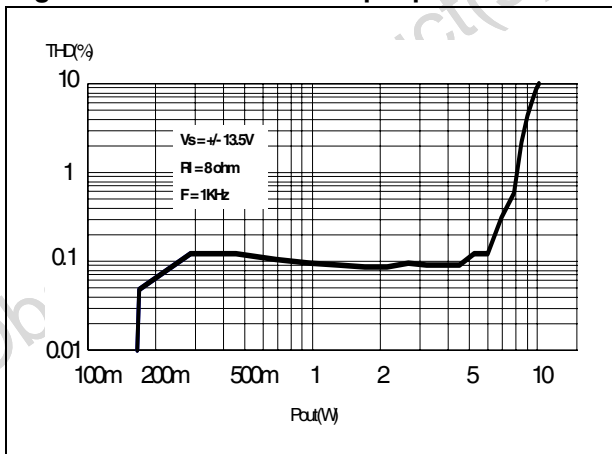
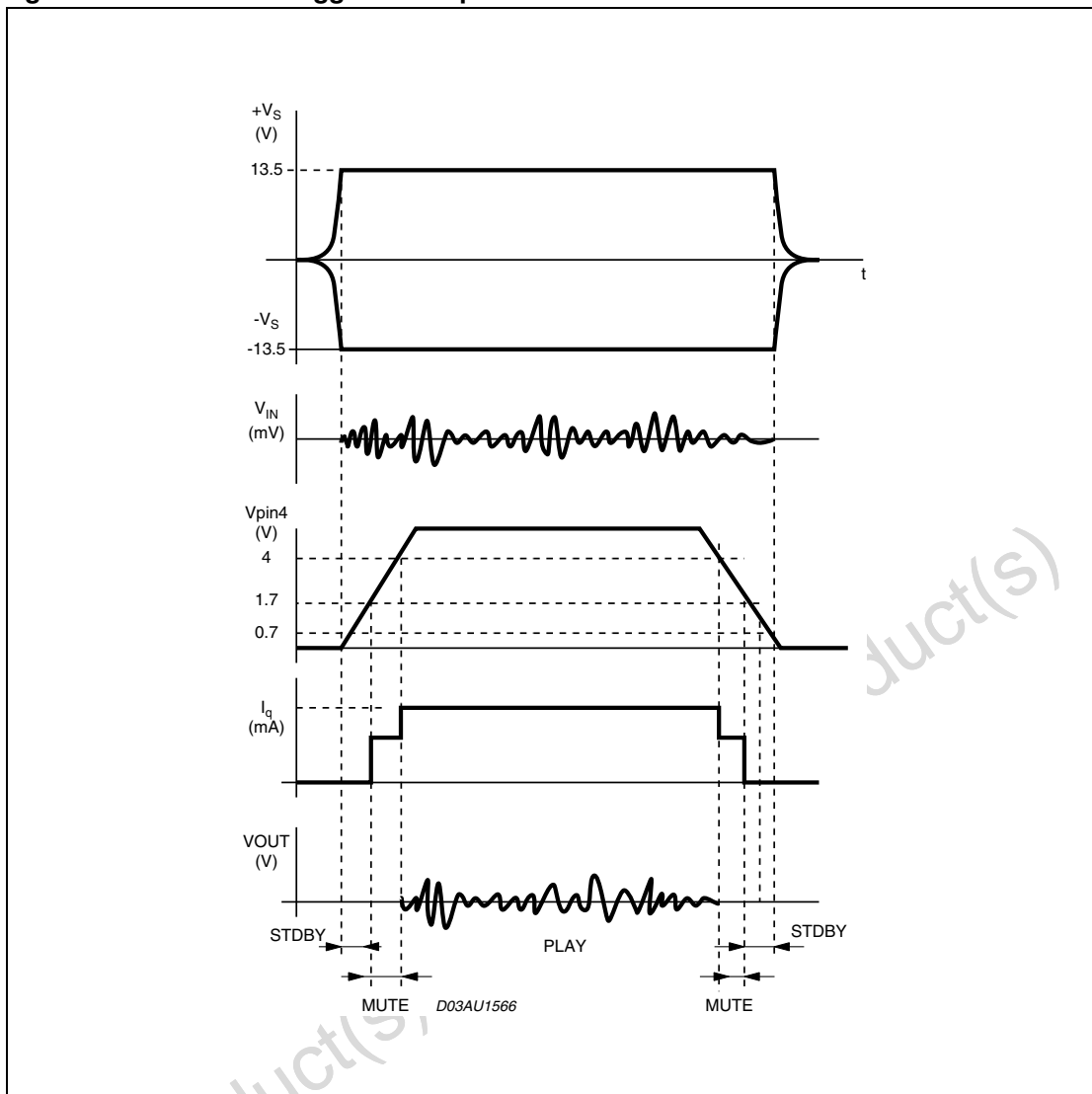

Figure 10. turn on/off suggested sequence



3 PCB

3.1 PCB and component layout

Figure 11. PCB component layout of the test circuit

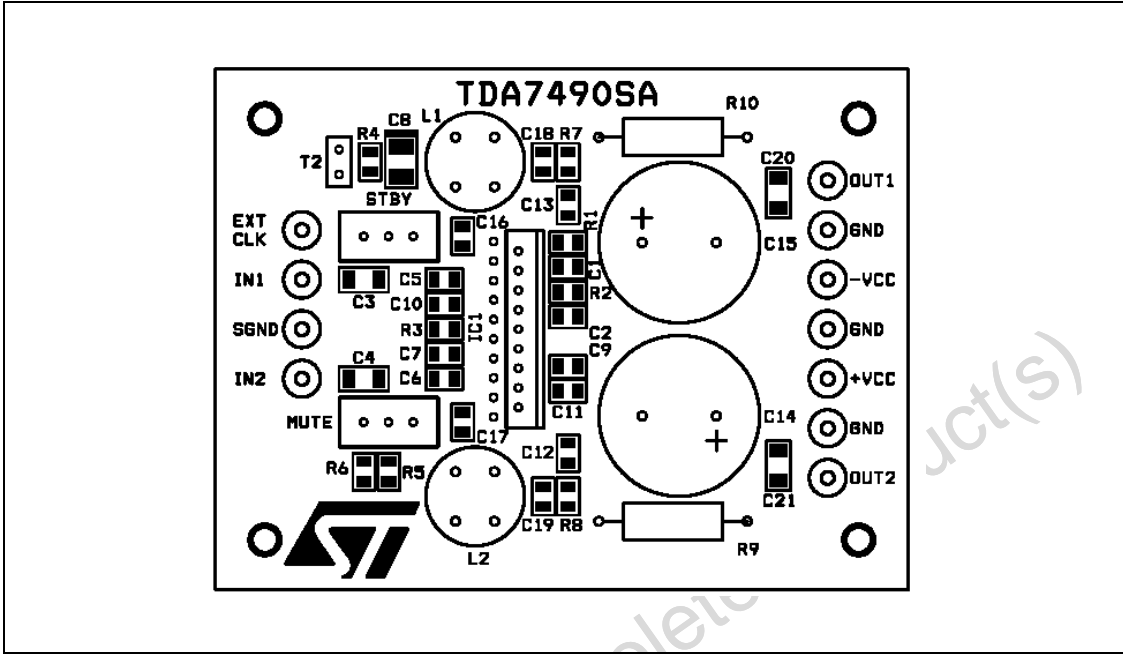

Figure 12. PCB copper bottom (top view)

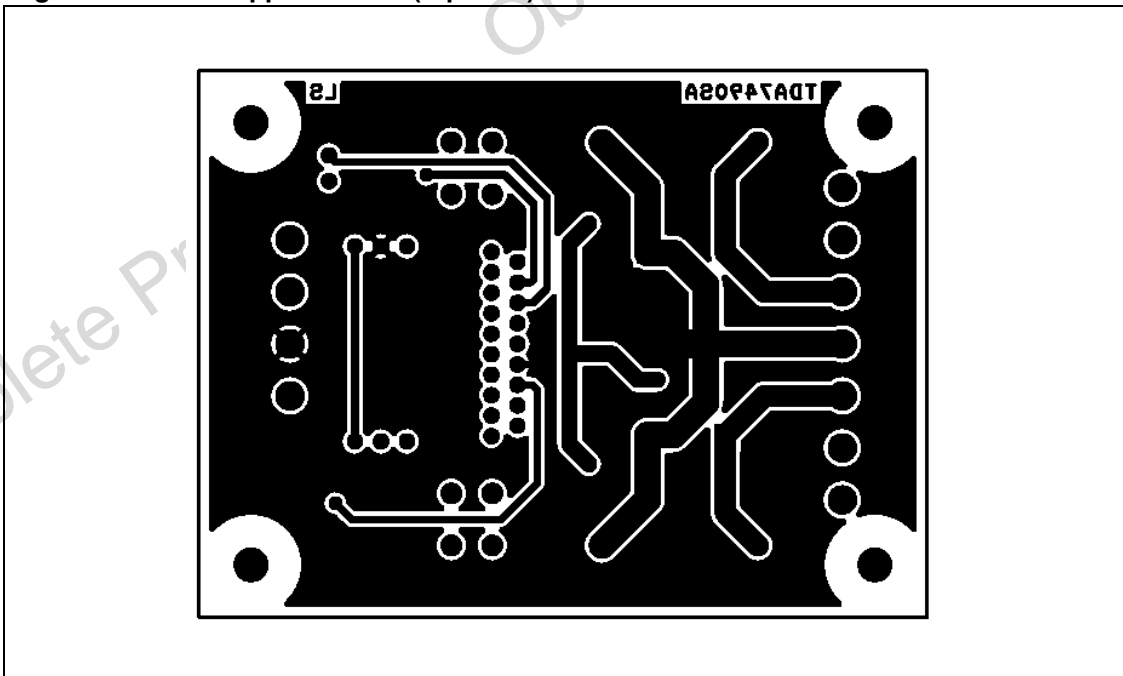
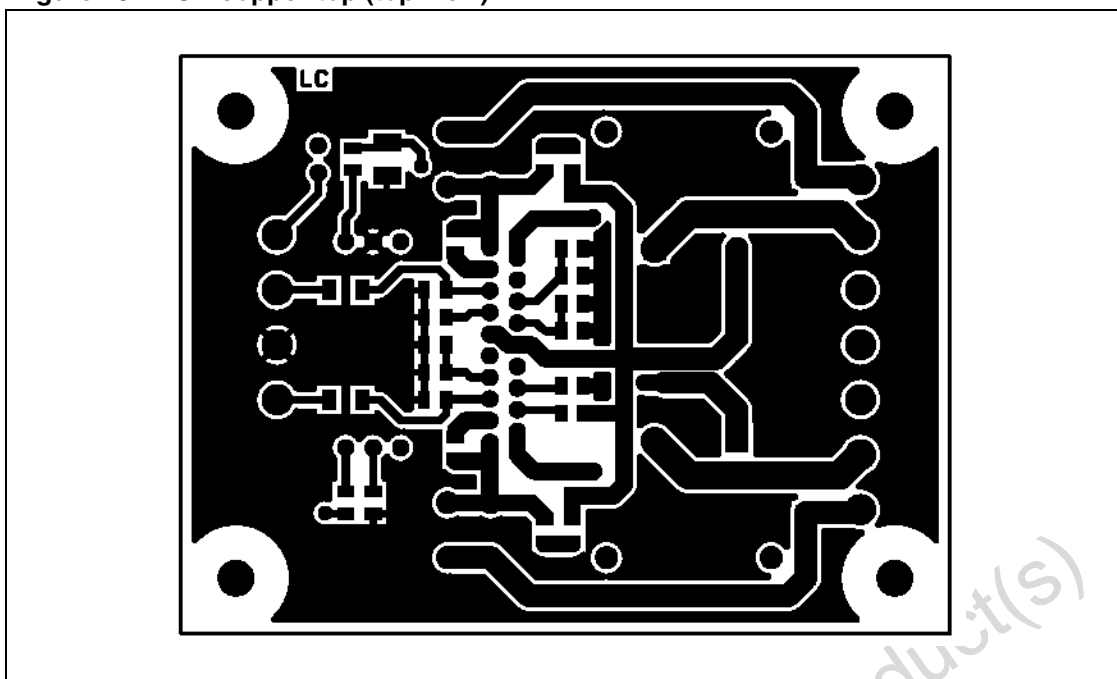
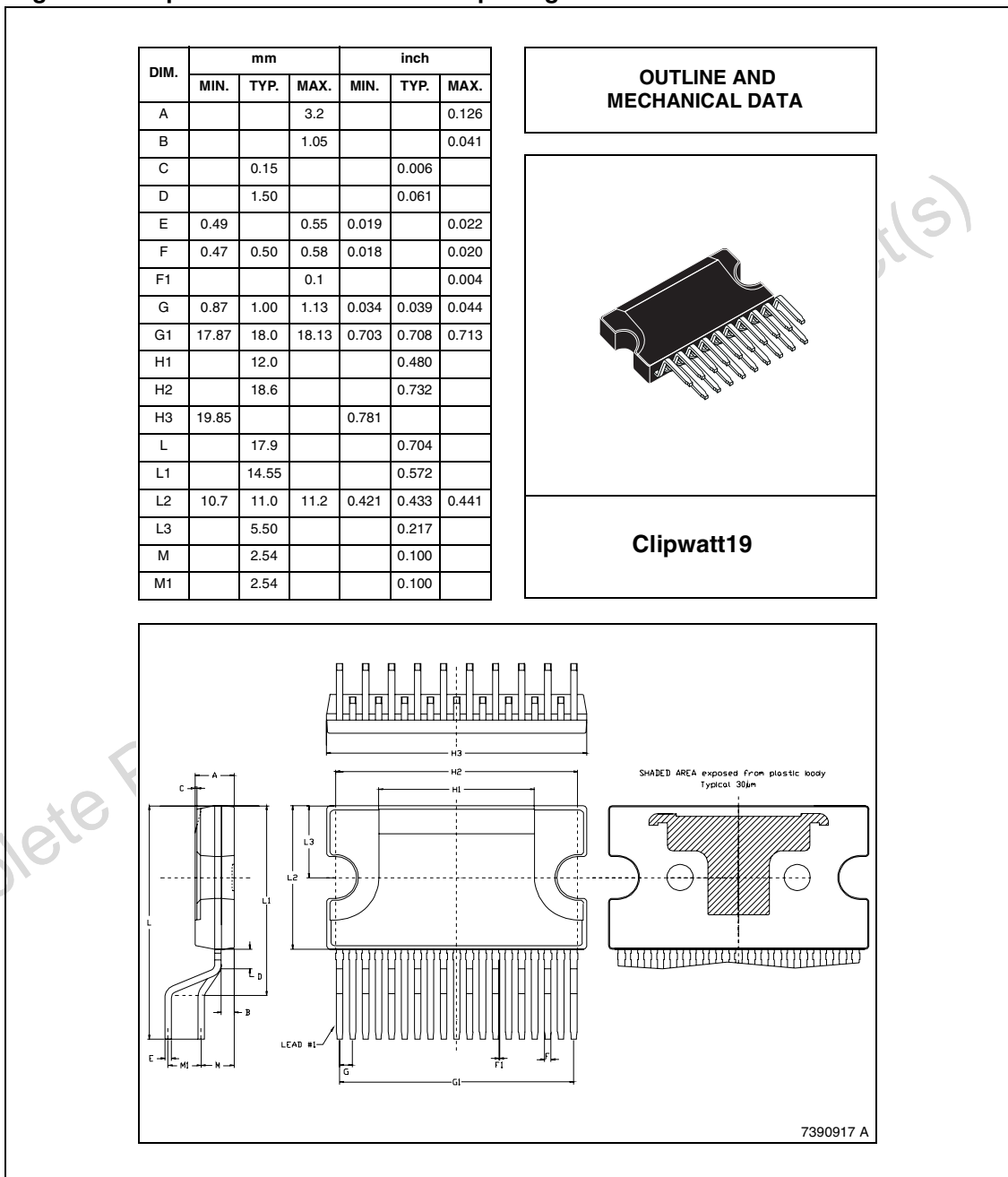

Figure 13. PCB copper top (top view)

4 Package information

In order to meet environmental requirements, ST offers these devices in ECOPACK® packages. These packages have a Lead-free second level interconnect. The category of second Level Interconnect is marked on the package and on the inner box label, in compliance with JEDEC Standard JESD97. The maximum ratings related to soldering conditions are also marked on the inner box label. ECOPACK is an ST trademark. ECOPACK specifications are available at: www.st.com.

Figure 14. clipwatt19 mechanical data & package dimensions



5 Revision history

Date	Revision	Changes
24-Nov-2005	1	Initial release.

Obsolete Product(s) - Obsolete Product(s)

Information furnished is believed to be accurate and reliable. However, STMicroelectronics assumes no responsibility for the consequences of use of such information nor for any infringement of patents or other rights of third parties which may result from its use. No license is granted by implication or otherwise under any patent or patent rights of STMicroelectronics. Specifications mentioned in this publication are subject to change without notice. This publication supersedes and replaces all information previously supplied. STMicroelectronics products are not authorized for use as critical components in life support devices or systems without express written approval of STMicroelectronics.



The ST logo is a registered trademark of STMicroelectronics.
All other names are the property of their respective owners

© 2005 STMicroelectronics - All rights reserved

STMicroelectronics group of companies

Australia - Belgium - Brazil - Canada - China - Czech Republic - Finland - France - Germany - Hong Kong - India - Israel - Italy - Japan -
Malaysia - Malta - Morocco - Singapore - Spain - Sweden - Switzerland - United Kingdom - United States of America

www.st.com