



life.augmented

ST25TV512C / ST25TV02KC Product presentation

MMY division





ST25TV512C/02KC main market segments

Luxury



Asset tracking, Brand recognition

Wine & Spirits



Product Identification, tamper proof application

Consumer Packaged Goods

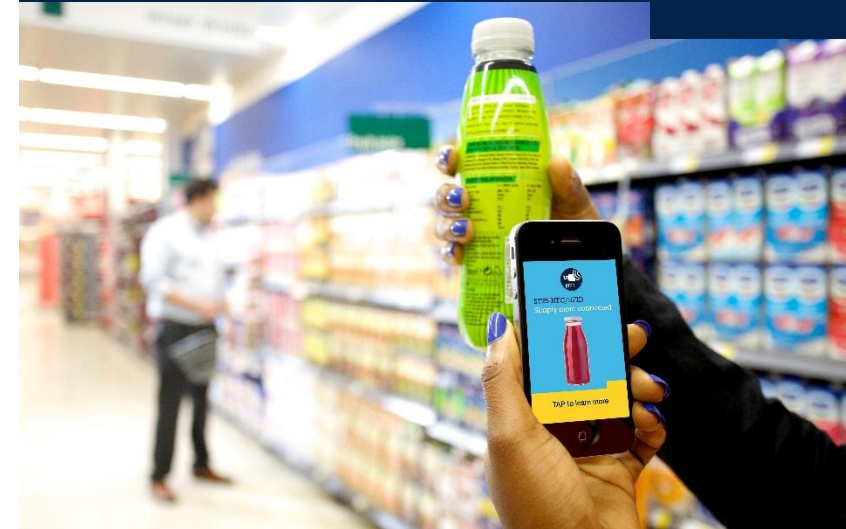

Consumer engagement



ST25TV512C/02KC use cases

Tamper detection, anti-counterfeiting



- **Detects** if the bottle has been **opened**

Brand protection, Accessory recognition



- Based on cloud management 

Traceability, Product identification



- Consumer engagement

Parameter setting



- Automatic and dynamic product configuration

Access control



- NFC / RFID badges to get access

Device personalization in production



- **In-the-box** quick personalization thanks to **Long range**



Typical RF range

NFC phones



ISO15693 (26kb/s)

Up to 7 cm / 3in.



ST25TVxxxC

EEPROM

RFID readers



Up to 40cm / 1.3ft

ISO15693 (26kb/s)

Up to 1.0 m / 3ft



ST25TVxxxC

EEPROM

Reduce your antenna dimension and make your product more robust thanks to ISO15693



ST25TV512C/02KC ID card



ST25TV512C / 02KC

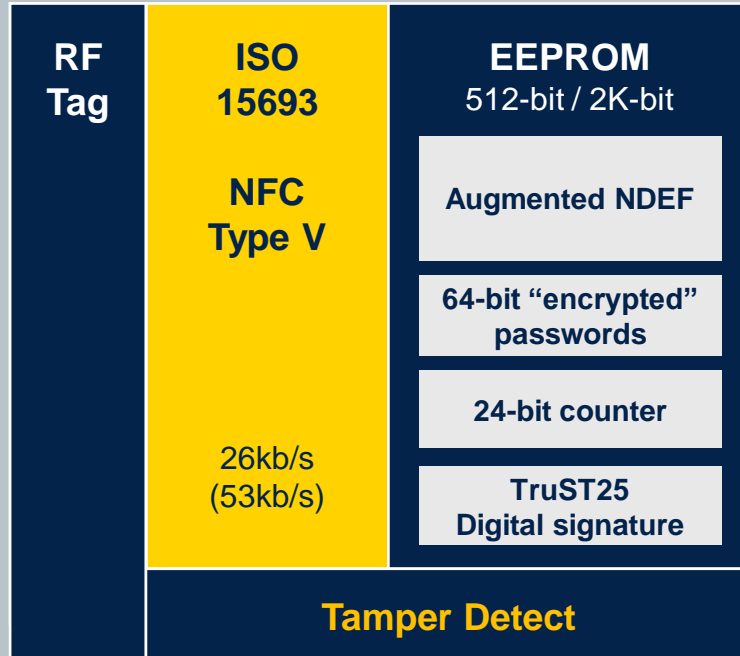

FPN5



SBN12 / SBN075

Die form, sawn and Bumped inkless 8" wafer, 120µm/75µm thickness

Use cases

- Product Identification, asset tracking, consumer engagement, access control, gaming
- Tamper proof application, brand protection



Key Features

- **ISO15693** and **NFC Type V** (long range operations, 26kb/s)
- **Memory configuration** : 512-bit and up to 2560-bit
- **TruST25 Digital Signature** (can be used into ANDEF : 2K-bit only)
- 24-bit **Unique Tap Code (UTC)** with anti-tearing
- **Untraceable** (by default possible) & Kill modes
- **Tamper Detect pin** for open / short detection
- **Augmented NDEF**: UID, UTC, Tamper status, custom field, PWD counter

Key Benefits

- **Configurable User Memory Area**
- Cloning Protection with **Digital Signature** (Cloud management)
- **60 years** data retention, **100k cycles** erase/write



ST25TV512C/02KC memory configuration (1/2)

Configurable memory

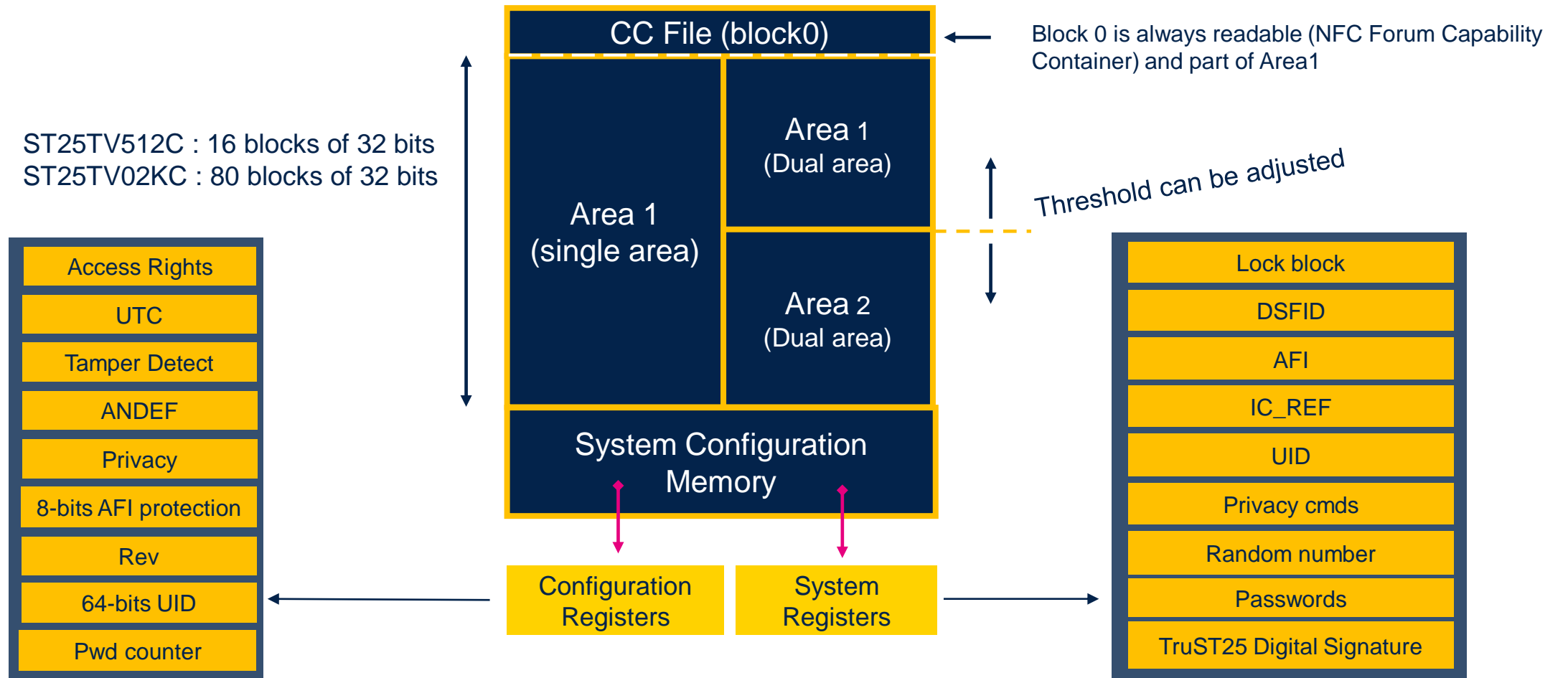



ST25TV512C/02KC memory configuration (2/2)

Flexible user memory configuration versus use cases

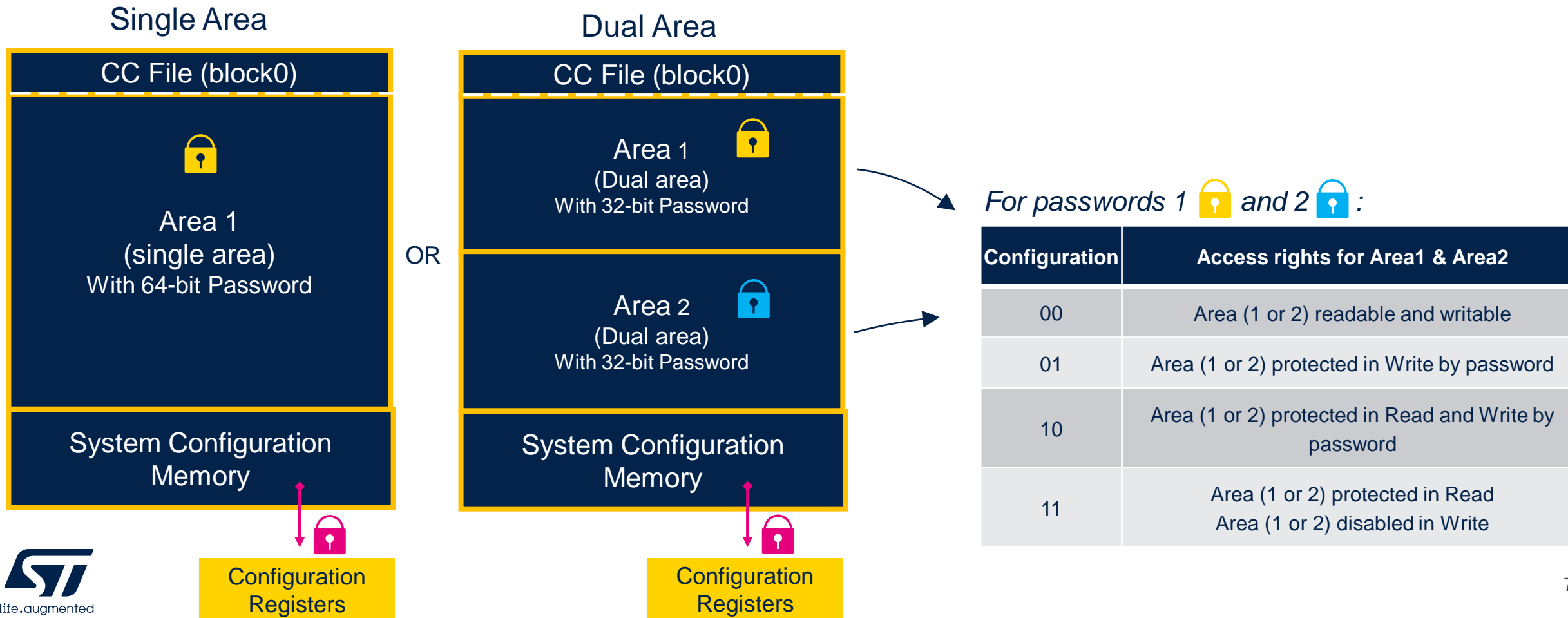







ST25TV512C/02KC data protection

64-bits encrypted password & LockBlock mechanism

- Encrypted password
 - Access to group of data are controlled by security sessions based on password
 - 4 passwords are available on the product :

Password	Access rights	Pwd size
 PWD_CFG	Configuration registers & kill mode	32-bits
 PWD_A1	Area1 blocks in user memory	32-bits in dual area 64-bits in single area
 PWD_A2	Area2 blocks in user memory	32-bits in dual area N/A in single area
 PWD_UNTR	Untraceable mode	32-bits

- LockBlock
 - It permanently protects a single block content against new writing
 - A single block is 4 bytes
 - Prerequisite : the addressed block must be available and write access granted
 - LockBlock command must be used

- The password data transmitted is **always** encrypted

- A limit on attempts of password presentation can be enabled and configured



ST25TV512C/02KC Augmented NDEF

Advanced NDEF message services

- The Augmented NDEF feature is a contextual automatic NDEF message service, allowing the tag to respond dynamic content without an explicit EEPROM update.
- Native operation : no mobile application required !





ST25TV512C/02KC Unique Tap Code (UTC)

Unique code generator

- The UTC is a code generated by the tag itself at each new RF session that makes the ANDEF message (see ANDEF slide) unique and dynamic.
- The UTC is coded in ASCII format and can be enabled/disabled.
- A dedicated Application Note AN5578 provides further information about this mechanism.



Fresh value generated during each RF boot sequence





ST25TV02KC-T tamper detect indication

Open or Close loop? / Only available on ST25TV02KC-T devices

- Overview

- The short impedance is under $\sim 7.5 \text{ k}\Omega$.
- State of tamper indication (Open / Close) can be read in a dedicated register
 - User need to use EEPROM to log the different states of the Tamper detect register
 - The first opening can be triggered

Provided by TD_STATUS Register (configuration register)

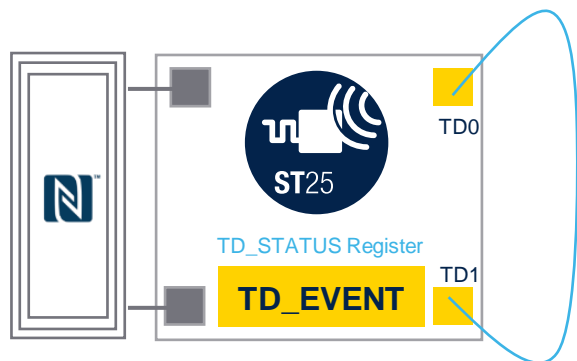

SHORT state

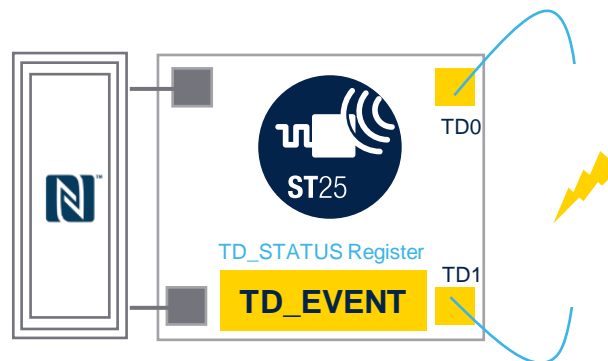

OPEN state

State	TD_EVENT	Meaning
SHORT	TD_SEAL	TD0 & TD1 connected
OPEN	TD_UNSEAL	TD0 & TD1 not connected
OPEN	TD_RESEAL	TD0 & TD1 connected and TD_UNSEAL already occurred

- 1) The information is kept during power off (permanent storage)
- 2) Tamper events occurring outside the field or during the current RF session are not detected

- Tamper detect function is considered as an indicator only and not a protection.
- Adding of physical protection and usage of a cloud reinforce the robustness of the solution



ST25TV512C/02KC kill mode

Kill mode : permanent deactivation of the tag

1) Before

The tag is ready/selected/quiet state



NFC phone

Kill request command

Non-reversible



2) After

The tag is in Killed state



NFC phone

Any RF commands



No RF communication possible





ST25TV512C/02KC untraceable mode (1/2)

Untraceable mode : to respect privacy

1) Before

The tag is ready/selected/quiet state

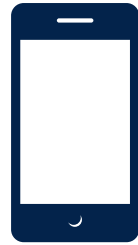

NFC phone or Reader

Enable untraceable mode



2) After

The tag is in Untraceable state



Reader

Proprietary commands

RF communication OK



Any other RF commands



No RF communication possible





ST25TV512C/02KC untraceable mode (2/2)

Untraceable mode : to respect privacy

1) Before

The tag is ready/selected/quiet state



NFC phone or reader

Enable untraceable mode



2) After

The tag is in Untraceable state



NFC phone

Can be configured by the user

Inventory supported (dummy UID) + proprietary commands

Inventory command NOT supported

RF communication OK

No RF communication possible





ST25TV02KC-T untraceable mode

Untraceable mode : further privacy services with ST25TV02KC-T series

- 1) ST25TV02KC-T can be configured to boot in untraceable state when tamper loop is open :

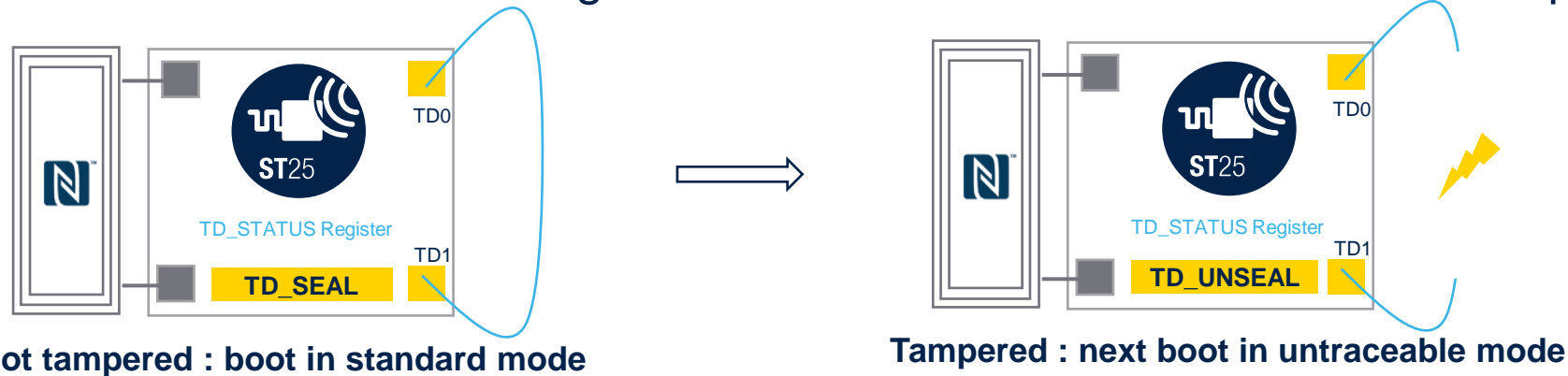

- 2) ST25TV02KC-T can be configured to enter the untraceable state when tamper loop is closed :

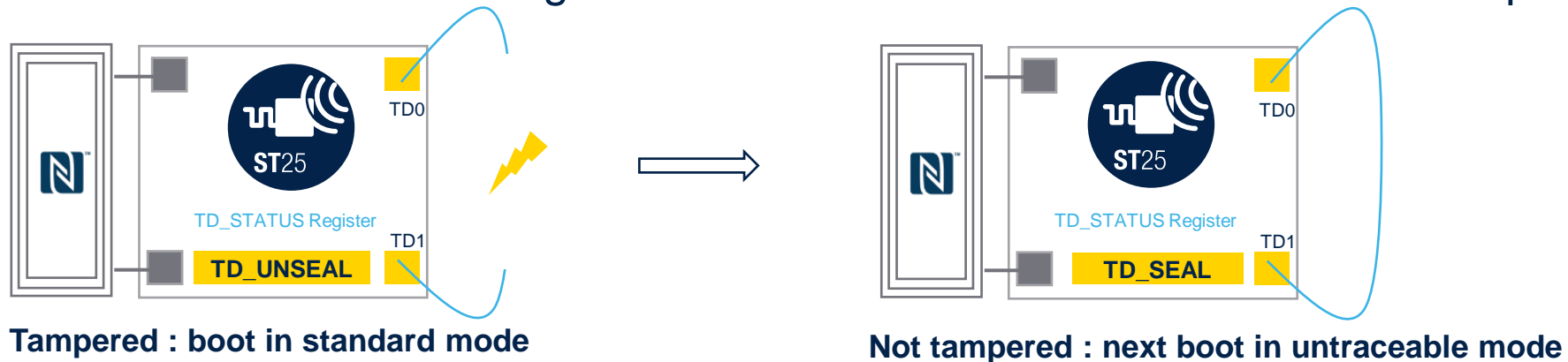



TruST25™ digital signature overview

Chip proven authenticity services

- TruST25™ encompasses industrialization processes and tools deployed by STMicroelectronics to create and write digital signature in house and that benefits from Secure product environment (HSM FIPS140-2)
- TruST25 is a STMicroelectronics trademark
- Digital signature allows applications to verify the authenticity of a product
- A dedicated application note AN5104 describes the digital signature and how to read and verify the TruST25™ digital signature. Application note distributed under SLA0085.
- Public Key will be sent to customers





NFC tuning frequency and internal tuning capacitance

	ST25TV512C ST25TV02KC
Standard	Based on ISO15693 + amendments 3 & 4 NFC Forum type V
Main carrier frequency	13.56MHz
Data sub-carrier frequency	423kHz / 484KHz
Optimal frequency tuning	13.6MHz – 14MHz
Internal capacitor (measured at 2V peak to peak)	23pF



ST25TV512C/02KC packages

Bump and FPN5 packages

○ Sawn & Bumped wafer

- ST25TV512C/02KC

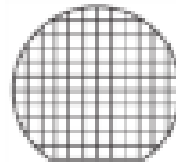
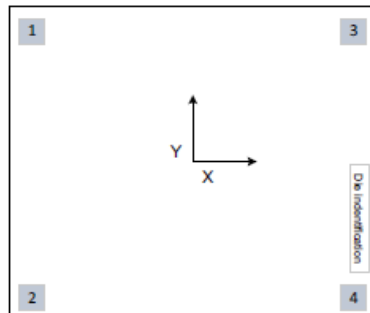

SBN12/075 *

* : sawn and bumped inkless
8" wafer, 120µm/75µm thickness

Bump	Signal Name
1	AC0
2	AC1
3	NC or TD0 for ST25TV02KC-T
4	NC or TD1 for ST25TV02KC-T

○ UFDFPN5 (DFN5) package

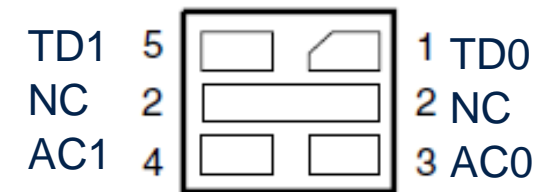

Bottom view



1.7 x 1.4mm / 0.55mm thickness



ST25TV512C/02KC rich eco-system



- Antenna e-design tool
- Schematic, BOM, Gerber
- Applications notes



- PC software tool based on ST25 SDK
- Mobile Apps ST25 SDK (Android & iOS)
- Evaluation board



- Documentation
- Training
- Webinar / MOOC
- E2E community



ST25TV02KC evaluation board

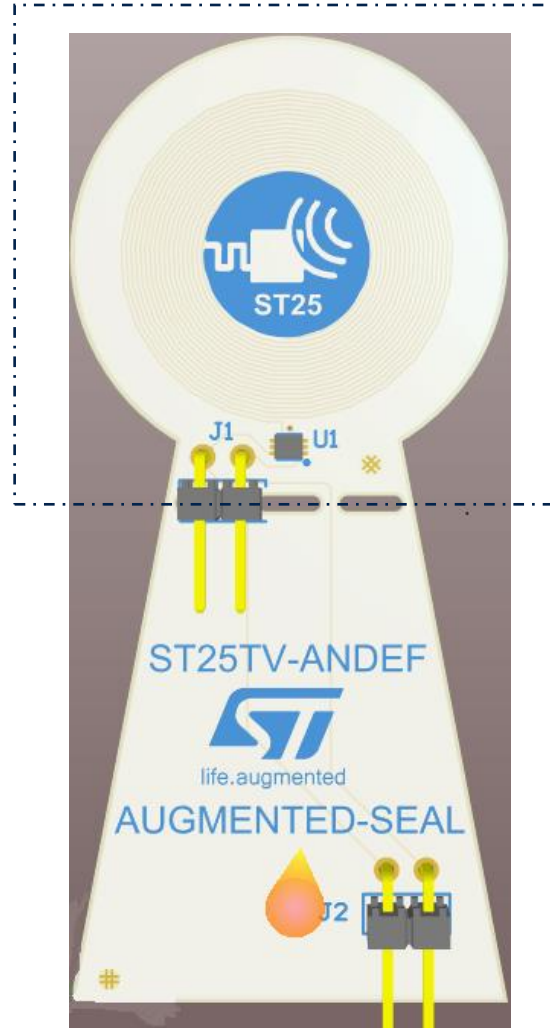

Removable area → can be integrated into a bottle cap for demo purpose

ST25TV02KC-ASEAL board

- **ST25TV02KC** NFC/RFID tag IC
- UDFPN5 package
- 22mm diameter - 18 turns antenna
- Featuring Tamper detect loop



Product part numbers



ST25TVxxxC-A	Package	512-bit	2k-bit
NFC Type 5 Tag ISO15693	SBN12 SBN075	ST25TV512C-AFG3 ST25TV512C-AFF3	ST25TV02KC-AFG3 ST25TV02KC-AFF3
ST25TV02KC-T	Package		2k-bit
NFC Type 5 Tag ISO15693 + Tamper Detect	SBN12 UFDFPN5		ST25TV02KC-TFG3 ST25TV02KC-TFH3



life.augmented

Solutions for NFC / RFID Tags & Readers



ST25 SIMPLY MORE CONNECTED