

TRANSIL™/TRISIL™ COMPARISON

INTRODUCTION

To protect a sensitive device there are two different approaches.

The first one is to use series protectors, the second one parallel suppressors. The technologies used in both cases are such that the series devices are suitable for long duration surges, while parallel protectors are very efficient for the high current short duration stresses which represent the great majority of cases.

For the parallel protection solutions, two philosophies can be used. The first one is represented by a breakdown based device and the second one by a breakover based protector, respectively known as the Transil and the Trisil.

Figure 1. Classical schematic of parallel protection

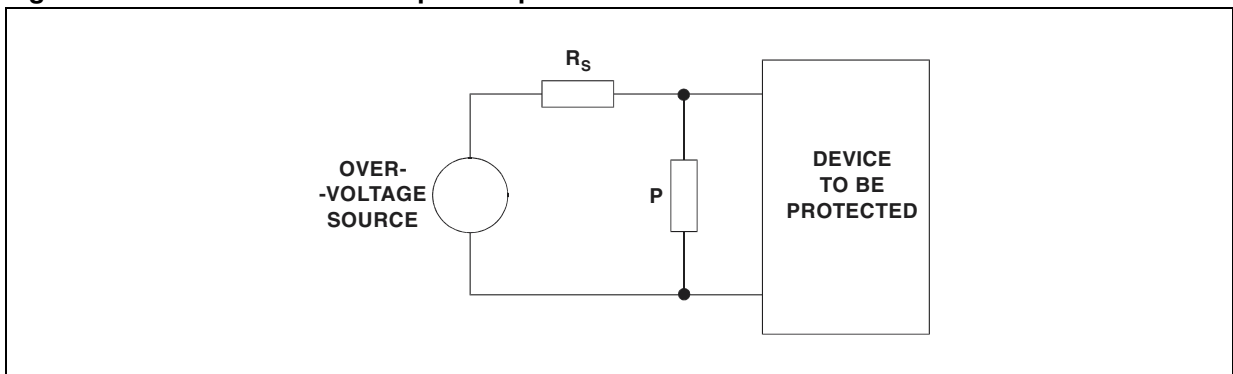

TRANSIL / TRISIL COMPARISON

Electrical characteristics

The Transil is a clamping device which suppresses all overvoltages above the breakdown voltage (V_{BR})

The Trisil is a crowbar device which switches on when overvoltages rise up to the breakover voltage ($\pm V_{BO}$).

Figure 2. Electrical characteristics

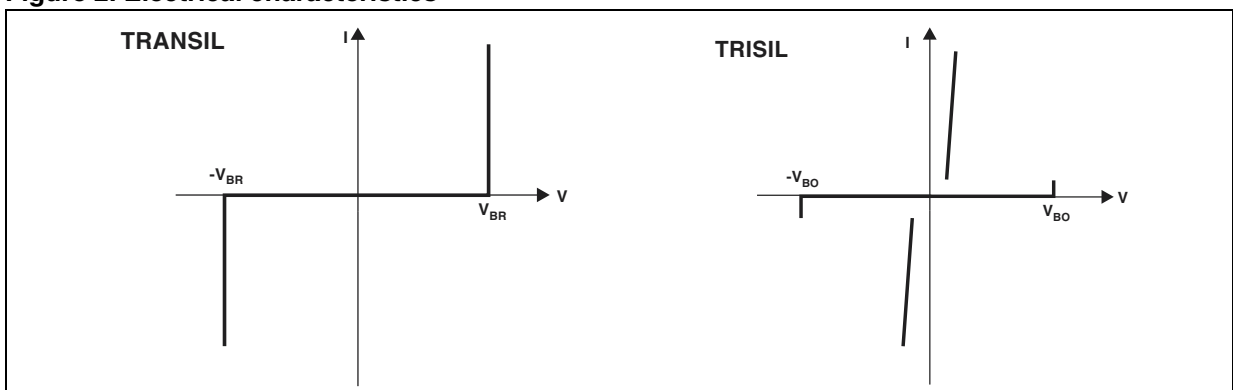

AN574 APPLICATION NOTE

Electrical Schematics

The Transil may be unidirectional (Figure 3 (A)) or bidirectional (Figure 3 (B)). In unidirectional form, it operates as a clamping device in one sense and like a rectifier in the other.

The Trisil may be designed to function with a fixed breakover value (Figure 3 (C)) or a value which can be programmed by the gate (Figure 3 (D))

Figure 3. Electrical Schematics

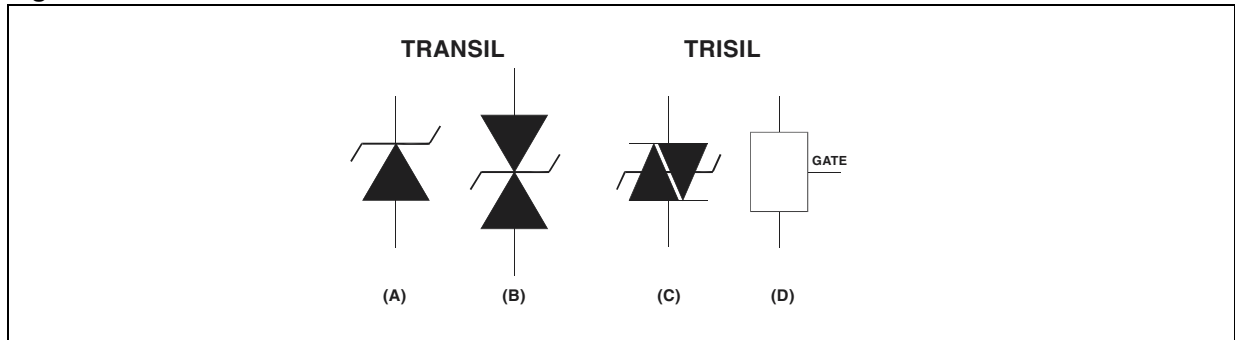

Electrical Behavior

Figure 4. Electrical behavior in a Transil and a Trisil

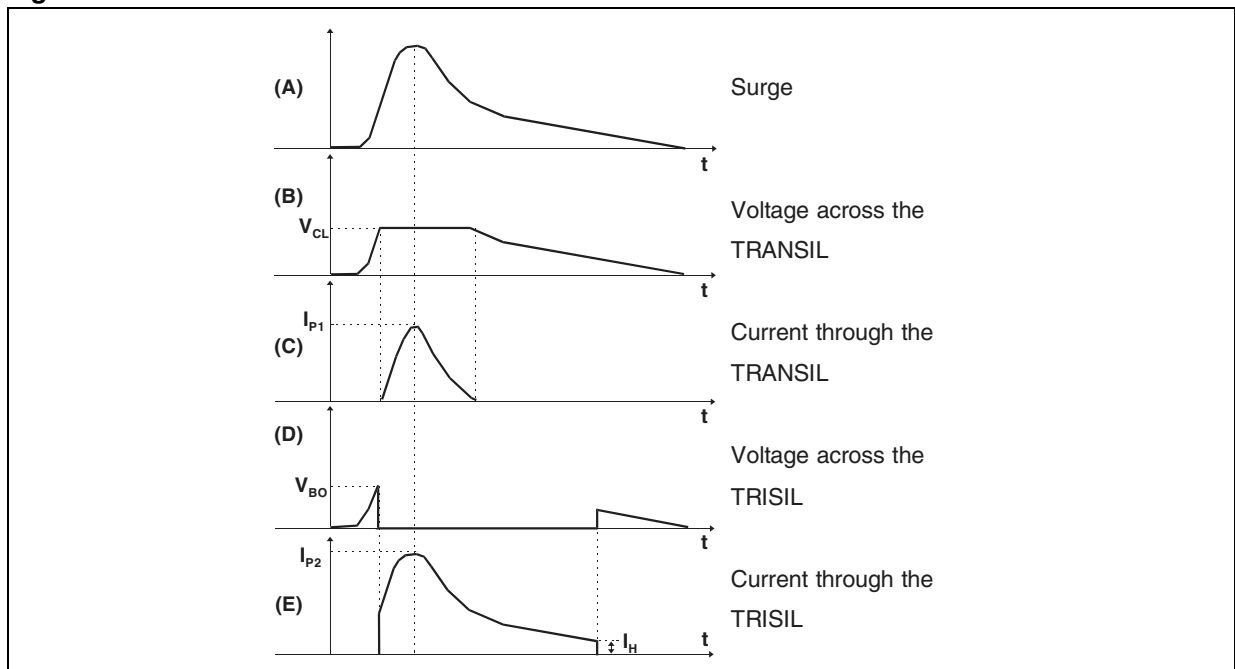

For the same surge (A), Figure 4 shows the electrical behavior of a Transil and a Trisil.

The parts (B) and (C) of Figure 4 give the voltage across the Transil and the current through it. It is important to note that the current flows through the protection device only during the clamping phase. This fact has to be taken into account when the protector is chosen, because the current duration is always shorter than that of the overvoltage surge.

The parts (D) and (E) of Figure 4 relate to the Trisil behavior. In this case the device fires when the voltage across it reaches the breakdown voltage V_{BO} and remains in the on-state until the current falls under the holding value I_H . The current flows through the Trisil during all of the on-state phase.

Power dissipation

The dissipated power in both the Transil and the Trisil is due to the presence of voltage across and current through the protection device.

Note that for the same package, the current-handling capability of a Transil depends on the breakdown voltage, whereas this is not the case for a Trisil.

For example, with the CB429 package we have the Transil series 1.5 KE and the Trisil family TPB which have different behavior in terms of current suppression.

Table 1. Current capabilities of Transil 1.5KE and Trisil TPB

	Current capability for 1ms wave			
	10V	62V	150V	220V
Transil 1.5KE	103A	17.7A	7.2A	4.6A
Trisil TPB		100A	100A	100A

As shown in table 1 the current rating of TPB devices is always 100 A whatever the V_{BR} value, while it depends on the V_{BR} for the 1.5KE series.

AN574 APPLICATION NOTE

SUMMARY

Table 2. Transil/Trisil Summary



	TRANSIL	TRISIL
TYPE OF ACTION	CLAMPING	CROWBAR
ELECTRICAL CHARACTERISTICS		
SCHEMATICS		
ELECTRICAL BEHAVIOUR		
ACTION START	$V_{surge} > V_{BR}$	$V_{surge} > V_{BO}$
ACTION STOP	$V_{surge} < V_{BR}$	$I < \text{Holding Current}$

Table 3. Transil/Trisil distinctive advantages

TRANSIL	TRISIL
No short - circuit across low - impedance lines, eg - power - supply.	Greater power handling due to lower voltage across terminals.
No need to ensure device switch - off after transient subsides.	Available with programmable breakover voltage.

Tables 2 and 3 summarize the different behavior and advantages of both Transil and Trisil devices. It is not possible to say "Transils are better than Trisils" or the opposite, only that their application areas are different. STMicroelectronics produces both types of devices meeting the widest protection requirements range.

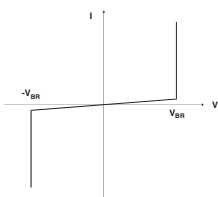
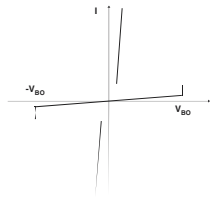
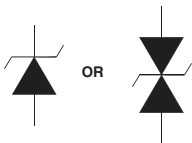
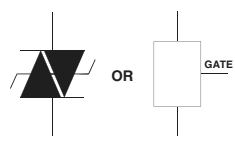
REVISION HISTORY**Table 4. Revision History**

Date	Revision	Description of Changes
November-1997	1	First Issue
10-May-2004	2	Stylesheet update. No content change.

Information furnished is believed to be accurate and reliable. However, STMicroelectronics assumes no responsibility for the consequences of use of such information nor for any infringement of patents or other rights of third parties which may result from its use. No license is granted by implication or otherwise under any patent or patent rights of STMicroelectronics. Specifications mentioned in this publication are subject to change without notice. This publication supersedes and replaces all information previously supplied. STMicroelectronics products are not authorized for use as critical components in life support devices or systems without express written approval of STMicroelectronics.

The ST logo is a registered trademark of STMicroelectronics.
All other names are the property of their respective owners

© 2004 STMicroelectronics - All rights reserved

STMicroelectronics GROUP OF COMPANIES

Australia - Belgium - Brazil - Canada - China - Czech Republic - Finland - France - Germany - Hong Kong - India - Israel - Italy - Japan -
Malaysia - Malta - Morocco - Singapore - Spain - Sweden - Switzerland - United Kingdom - United States

www.st.com