



AN1894 APPLICATION NOTE

VIPower: VIPer12A NON ISOLATED BUCK AND BUCK-BOOST CONVERTER REFERENCE BOARD

P. LIDAK - R. HAUSER

ABSTRACT

Presented circuit can be used to produce a single, non isolated positive or negative voltage. It is dedicated for building an auxiliary power supply based on the VIPer12AS monolithic device with rather low output power required.

1. INTRODUCTION

There are some applications, where an off-line power supply without isolation between input and output can be tolerated and rather low output current is required. In this case the converter should be simple and low cost. These requirements can be satisfied by a step-down converter based on monolithic device VIPer12AS that incorporates the PWM controller together with the Vertical power MOSFET switch in a SO8 package. The presented power supply has two variants. The first is a buck (step-down) converter with a positive output voltage referenced to the common ground. The second one with negative output voltage is a buck-boost converter. The presented reference board incorporates both variants by different assembly options.

2. CIRCUIT DESCRIPTION

2.1 Buck Converter +15V/100mA, +5V/60mA or 20mA (Variant 1)

2.1.1 Operating Conditions

Input Voltage range	90-264 VAC
Input Voltage Frequency range	50/60 Hz
Main Output	15V / 100mA
Second Output (through linear regulator)	5V / 60 or 20mA
Total Maximum Output Power	1.6W

2.1.2 Circuit Operation

The total schematic of the power supply can be seen in Figure 1. The output of the converter is not isolated from input. For this reason the reference ground is common for an input and output connection terminal. The input capacitor C1 is charged from line via one way rectifier consisting of diodes D1 and D2. Two diodes in series are used for EMI reasons to sustain burst pulses of 2kV. The capacitor C1 together with capacitor C2 and inductor L1 forms an EMI filter. The DC voltage at C2 is then applied to the VIPer12 that works as a high side switch. It means the IC and corresponding supply and feedback loop circuitry is floating. The IC supply circuit consists of the high voltage diode D4, ceramic capacitor C7 low voltage D7 and capacitor C4. The voltage feedback loop is provided via zener diode D3, resistor R3 and capacitor C6.

The diode D7 between capacitor C7 and C4 ensures the proper start-up of the converter. Thanks to this diode the feedback loop circuit is separated from supply circuit. The internal start-up current source of the VIPer12 charges the IC supply capacitor C4 to a specified start-up threshold voltage of about 16V.

2.1.3 Bill of Materials

The bill of material that corresponds to the Figure 1 can be seen in Table 1.

Table 1: Bill of Material for Non Isolated Buck Converter with Positive Output Voltage

Ref.	Q.ty	Value	Description
CON1	1		WECO 10.877.002 - clamp, 2 pole, horizontal, type 94 380V 15A
CON2	1		WECO 10.877.003 - clamp, 3 pole, horizontal, type 94 380V 15A
C1, C2	2	4.7uF	Nippon Chemi-Con KMG 400 VB 4R7 M Electrolytic capacitor KMG 400V 20%
C3	1	56uF	Nippon Chemi-Con LXY 35 VB 56 M F11 Electrolytic capacitor LXY 35V 273mA 0.35R 20% -
C4	1	10uF	Nippon Chemi-Con KME 50 VB 10 M Electrolytic capacitor KME 50V 20%
C6	1	22nF	Ceramic capacitor X7R 50V 10%
C7	1	100nF	Ceramic capacitor X7R 50V 10%
C8	1	100nF	Ceramic capacitor X7R 50V 10%
D1, D2	2	GL1M	Diotec GL1M diode, trr=1.5us 1000V 1A
D3	1	ZMM13	Zener diode 13V 0.5W 5%
D4, D5	2	RGL34J	Diotec RGL34J Fast recovery diode trr=250ns 600V 0.5A
D6	1	ZMM18	Zener diode 18V 0.5W 5%
D7	1	LL4148	LL4148 diode 75V 200mA
L1	1	1.5mH	EPCOS B78108-S1155-J inductor, bobbin core BC 100mA 23R 10%
L2	1	1mH	EPCOS B82144-A2105-J inductor, large bobbin core LBC 200mA 3.8R 10%
R1	1	10R	Yageo 254-0 10R 5% 1J resistor, wirewound, fusible, TK120 CRF 254-4 3W 5%
R3	1	1k	resistor, metal film 100V 0.125W 1%
R5	1	0R	resistor, metal film
R6	1	0R	resistor, metal film
U1	1	VIPer12AS	STMicroelectronics VIPer12AS Off-line SMPS Primary IC 730V 0.4A 27R
U2	1	L78L05CD	STMicroelectronics L78L05CD positive voltage regulator 5V 100mA 10%, for variant 1b
U3	1	L78M05CDT	STMicroelectronics L78M05CDT positive voltage regulator 5V 0.5A 5%, for variant 1a

AN1894 - APPLICATION NOTE

2.1.4 PCB Layout

The PCB is designed as single sided board made of FR-4 material with 35mm copper plating with solder and silk screen mask. The assembled board contains both SMD and through hole components. The board incorporates both a buck and buck-boost variant of the converter. The outline dimensions are 38x29mm. Assembly top side (through-hole components) and solder bottom (SMD components) side can be seen in Figure 2 and Figure 3.

Figure 2: Assembly Top (not in scale)

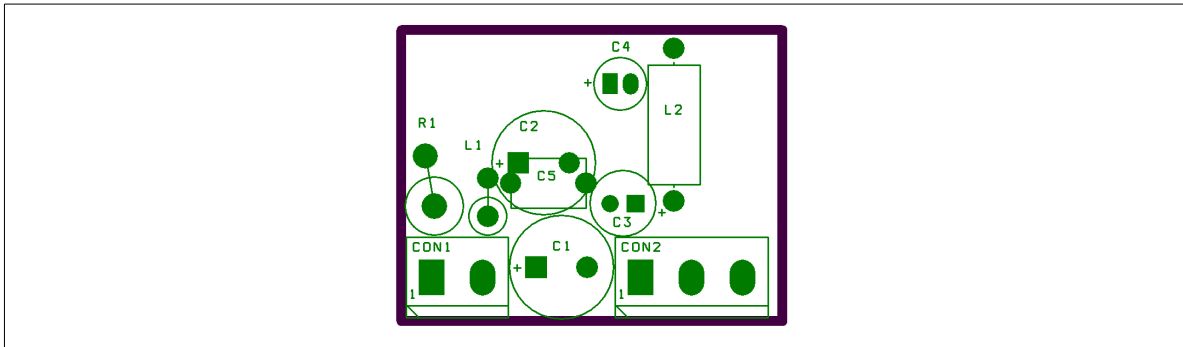

Figure 3: Assembly Solder Side (not in scale)

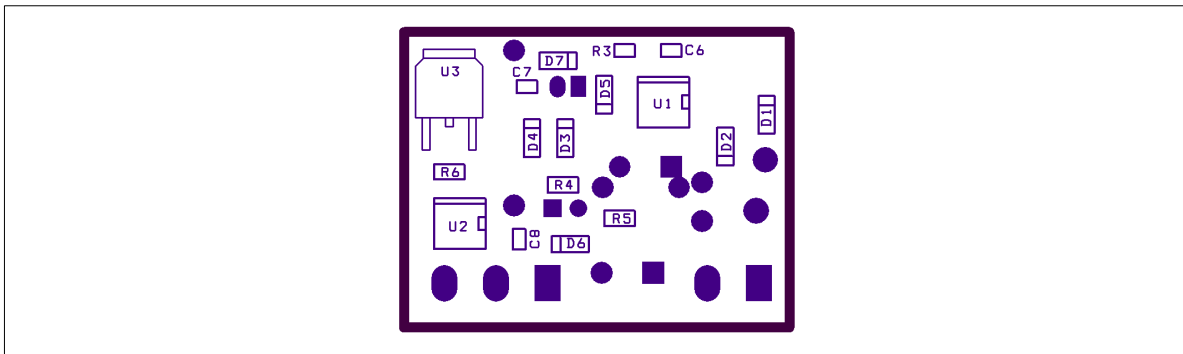
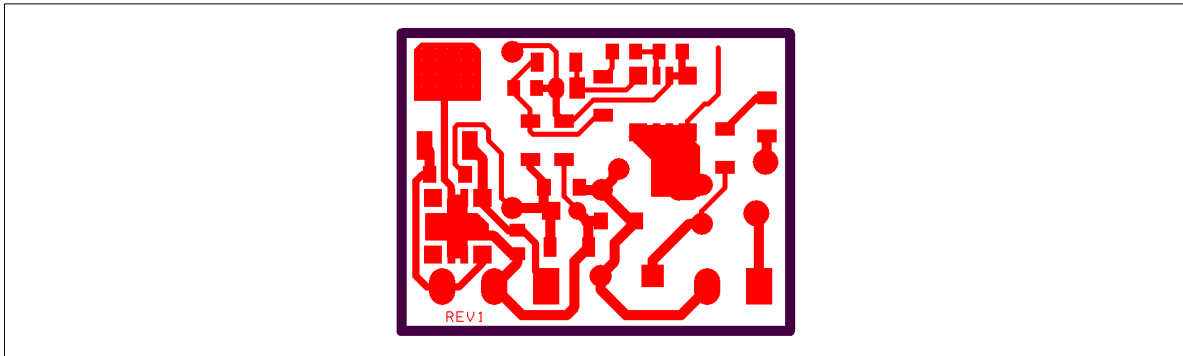

Figure 4: PCB Layout (not in scale)



The PCB layout of the copper connections is depicted in Figure 4. The holes for through-hole components are not seen in the picture.

The physical appearance of the converter can be observed from Figure 5.

Figure 5: Picture of the Converter



2.1.5 Buck Converter Evaluation and Measurements

The output regulation characteristics can be seen in Figure 6. It shows the variation of the output voltage with output current at specific DC input voltage. The zener diode D6 was not connected during the measurements

Figure 6: Output Regulation Characteristics (Parameter is V_{in})

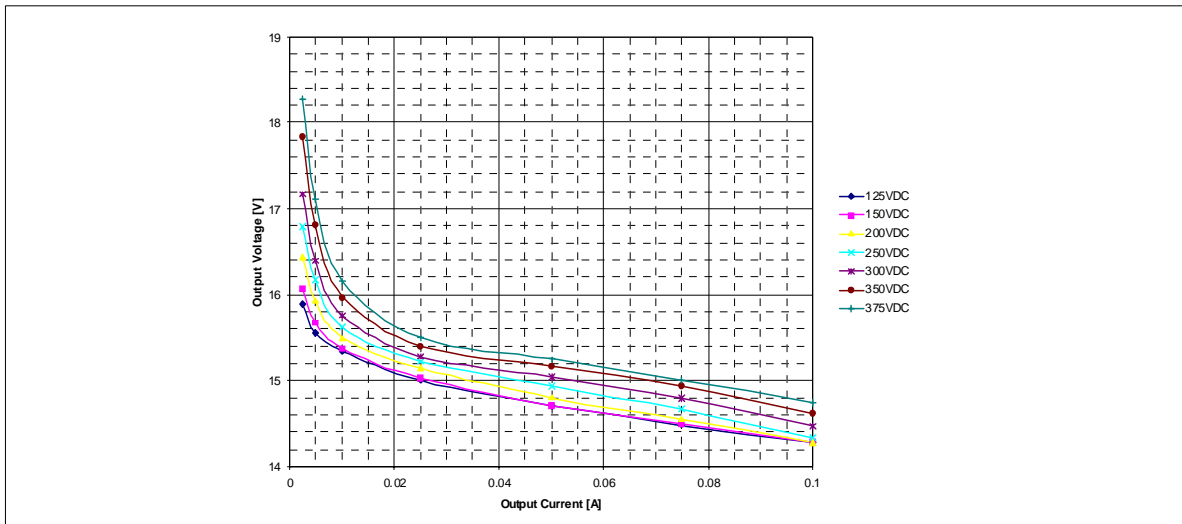

Using the same measured values, Figure 6 can be redrawn using a different parameter. Figure 7 shows the variation of the output voltage with input DC voltage change. The output current is the parameter in this case.

AN1894 - APPLICATION NOTE

Figure 7: Output Regulation Characteristics (Parameter is I_{out})

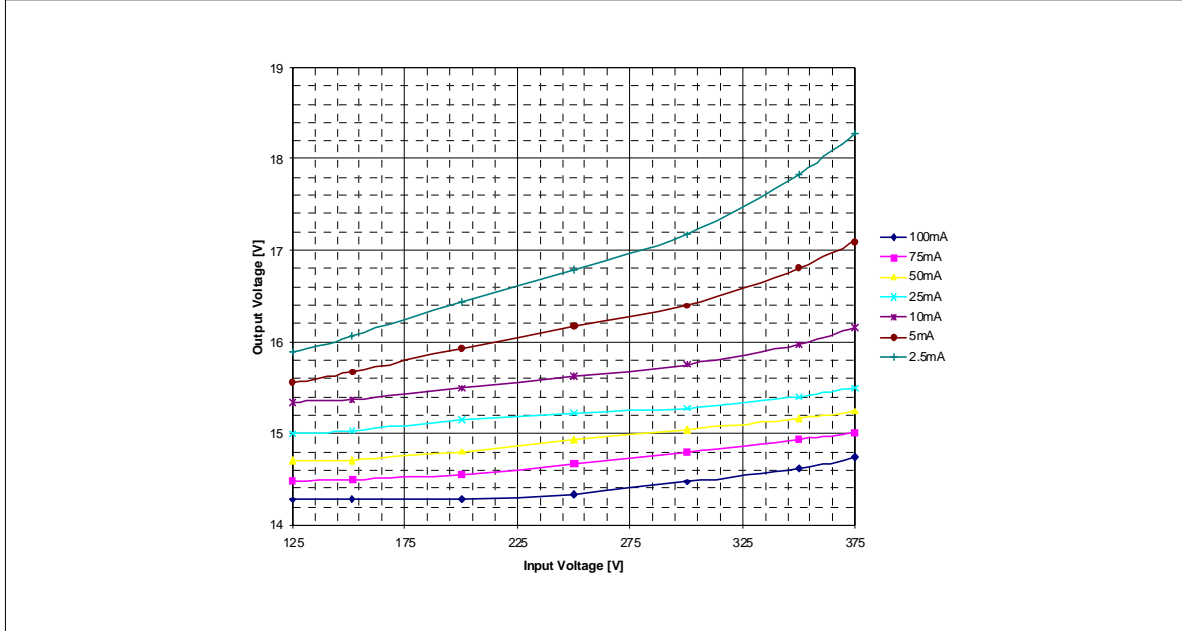

One of the most important and observed characteristics is the converter's efficiency. Figure 8 depicts the dependency of the efficiency on the input voltage (parameter is output current) while Figure 9 shows the dependency on the output current (parameter is input voltage).

Figure 8: Efficiency variation with input voltage (Parameter is I_{out})

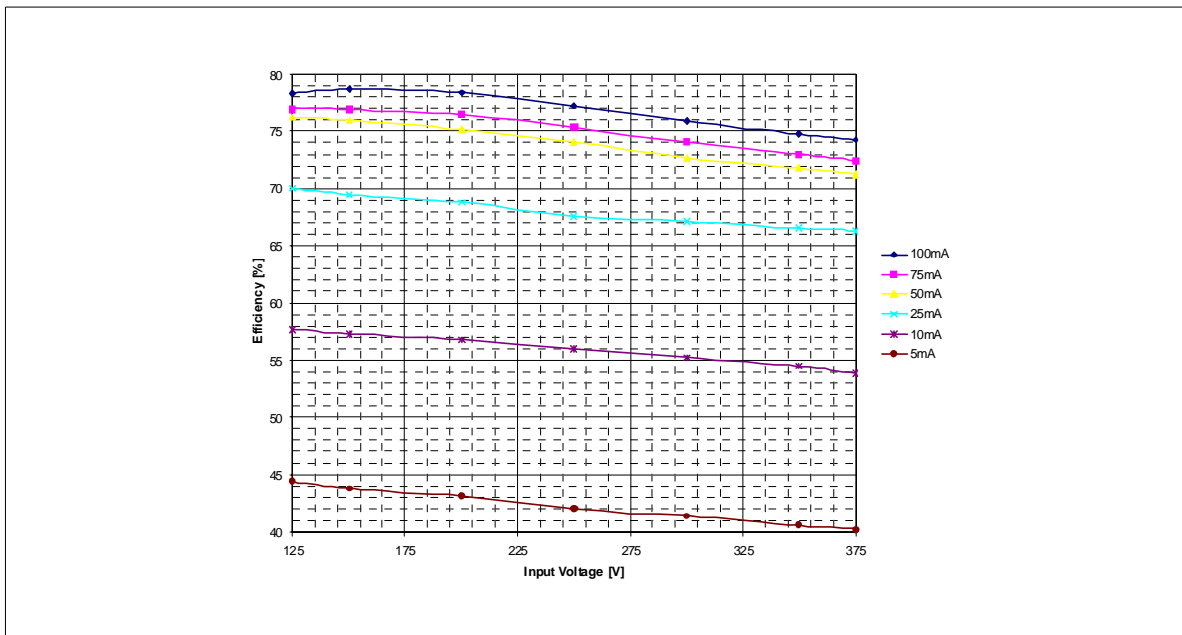
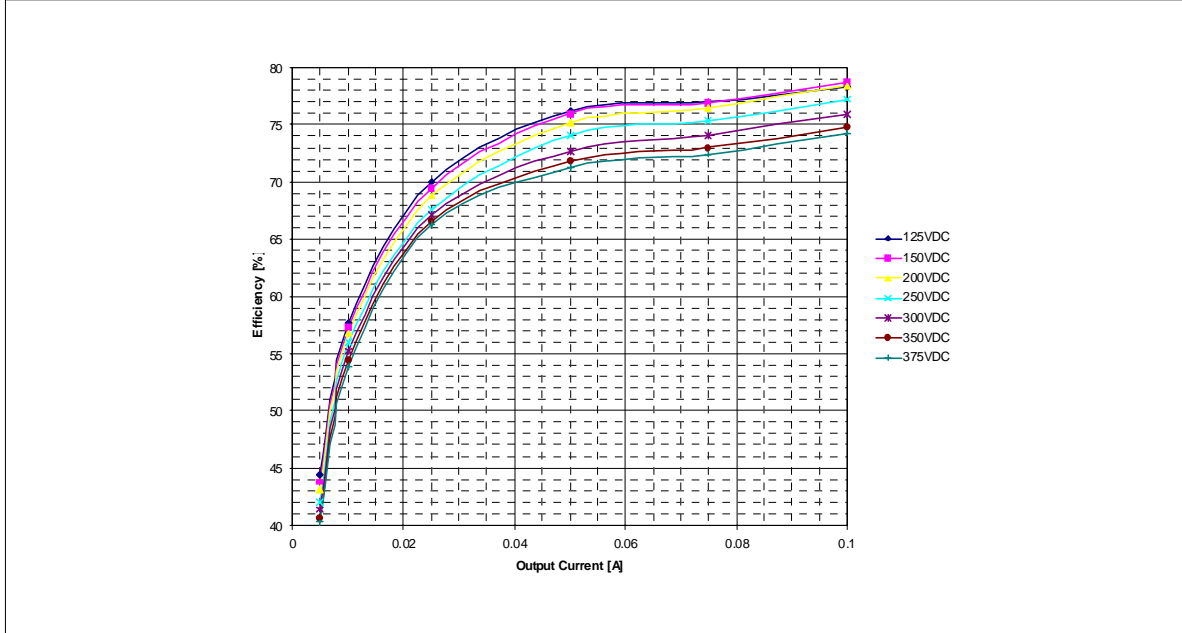

Figure 9: Efficiency variation with output current (Parameter is V_{in})



Following pictures starting from Figure 10 to Figure 17 show the most important voltage or current waveforms at different input and output conditions. Channel 1 (pink) is the power MOSFET Source terminal voltage of the VIPer12. Channel 4 (red) shows the inductor current. The purpose of those pictures is to demonstrate the skipping cycle function at light or no-load condition and cycle-by-cycle primary current limitation at overload or output shorted condition.

Figure 10: $V_{in}=127VDC$, $I_{out}=100mA$

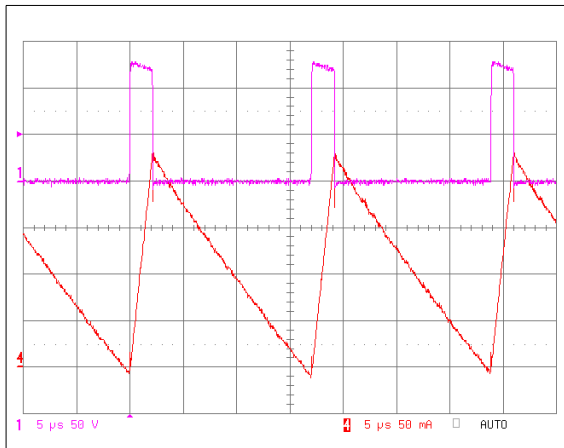
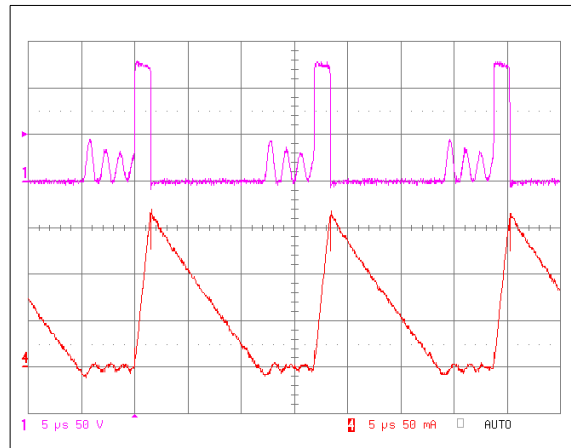

Figure 11 : $V_{in}= 127VDC$, $I_{out}= 50mA$



AN1894 - APPLICATION NOTE

Figure 12 : $V_{in}= 373\text{VDC}$, $I_{out}= 100\text{mA}$

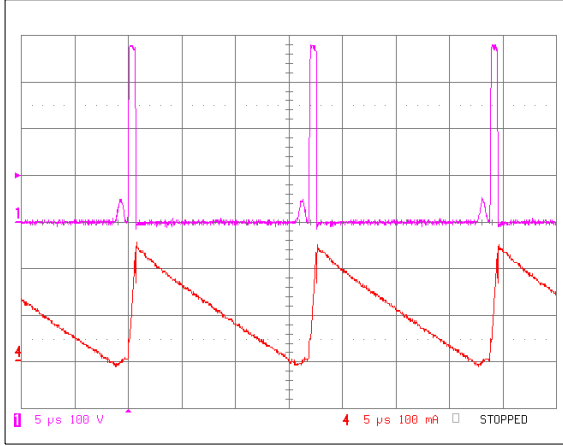

Figure 13 : $V_{in}= 373\text{VDC}$, $I_{out}= 50\text{mA}$

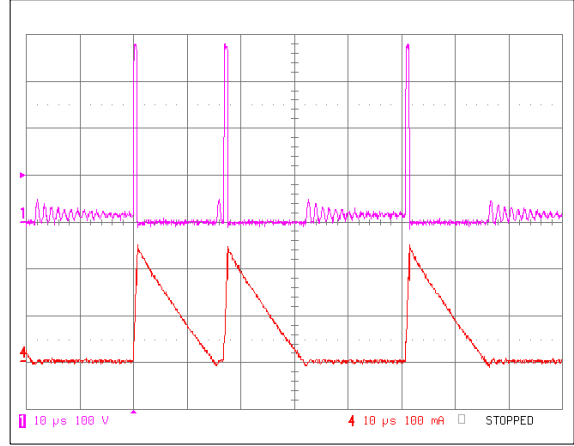

Figure 14 : $V_{in}= 373\text{VDC}$, no-load

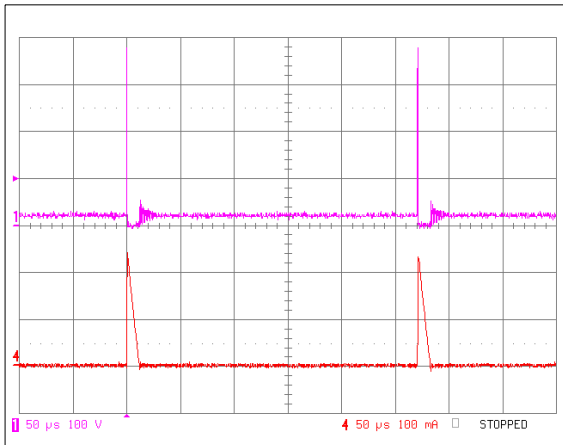

Figure 15: $V_{in}= 127\text{VDC}$, no-load

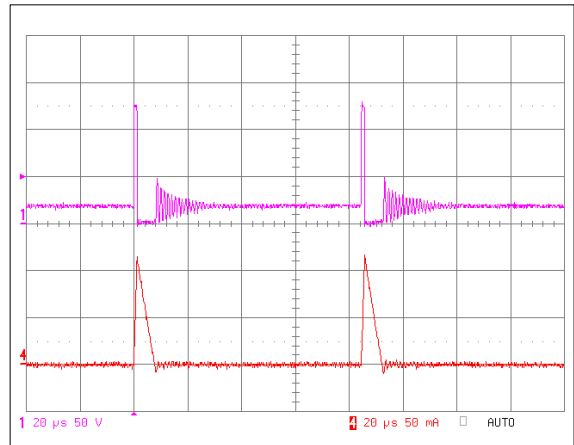

Figure 16: $V_{in}= 127\text{VDC}$, output shorted

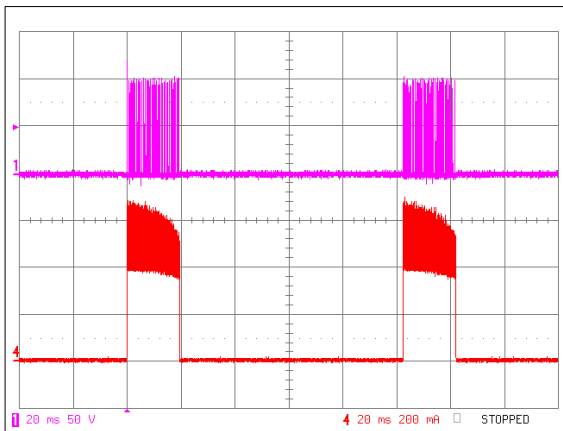
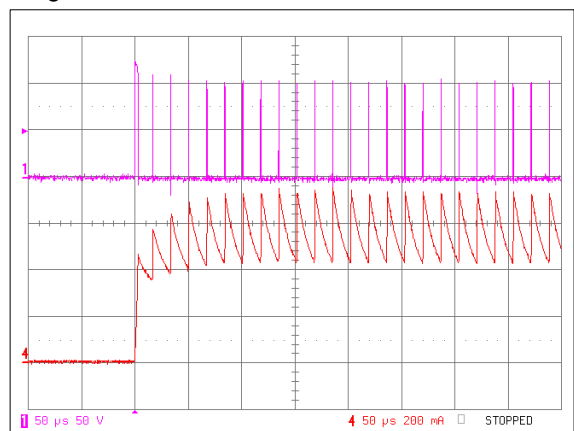

Figure 17: $V_{in}= 127\text{VDC}$, output shorted, burst magnified



Furthermore conducted emissions were measured in neutral and line wire using peak or average detector. The measurements were performed at 230VAC input voltage and the 15V output was fully loaded by 100mA load. The presented results depicted from Figure 18 to Figure 21 show the results. For compliance with the EN 55014 standard, a small input filter (X-capacitor, common mode choke) should be added, if there is no EMI filter for the complete system. Alternatively, a double sided pcb can be used.

Figure 18: Phase L, average detector

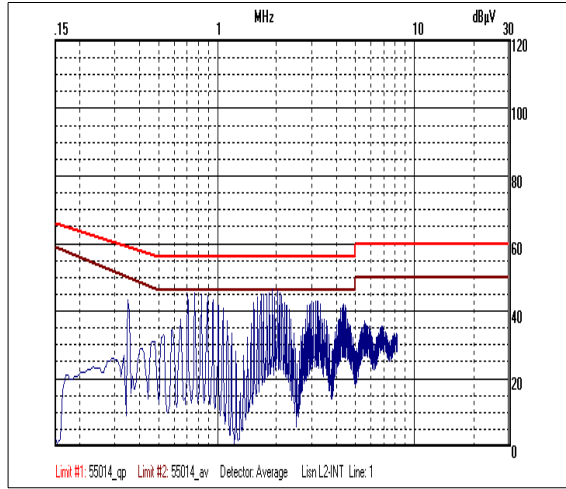

Figure 19: Phase L, peak detector

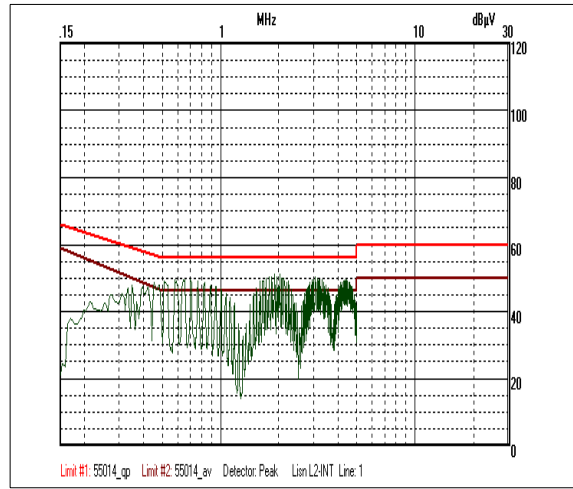

Figure 20: Phase N, average detector

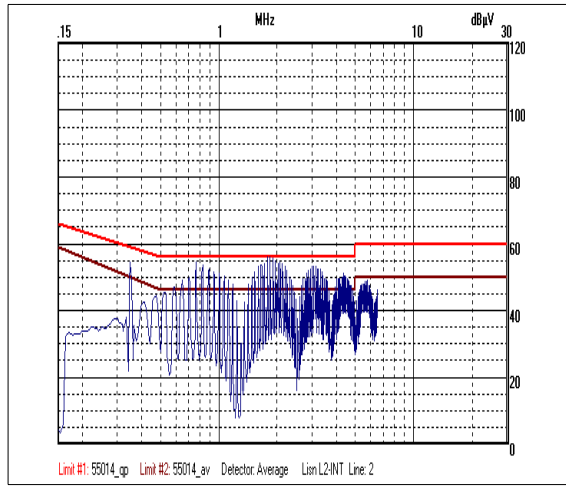
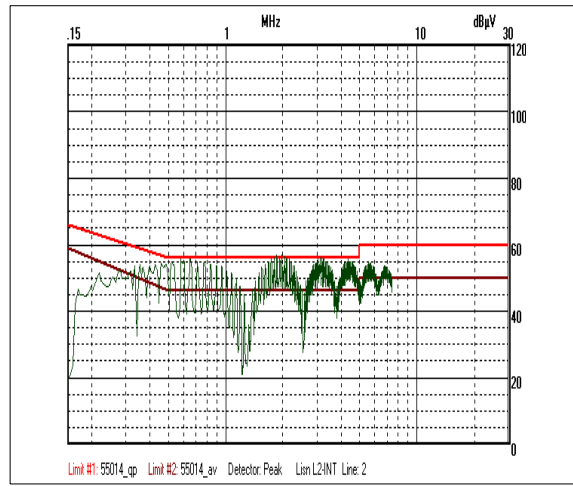

Figure 21: Phase N, peak detector



2.2 Inverting Converter -15V/100mA (Variant 2)

2.2.1 Operating Conditions

Input Voltage range	90-264 VAC
Input Voltage Frequency range	50/60 Hz
Output	-15V / 100mA
Total Maximum Output Power	1.5W

Figure 23: Output Regulation Characteristics (Parameter is V_{in})

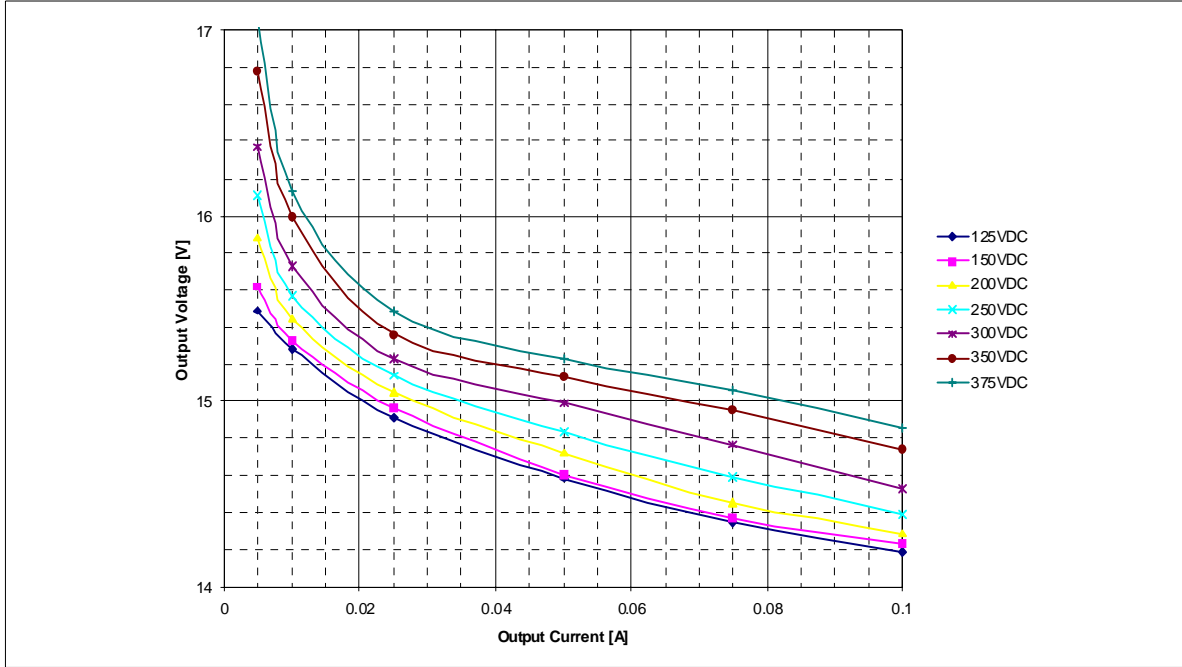

Using the same measured values, Figure 23 can be redrawn using a different parameter. Figure 24 shows the variation of the output voltage with input DC voltage change. The output current is the parameter in this case.

Figure 24: Output Regulation Characteristics (Parameter is I_{out})

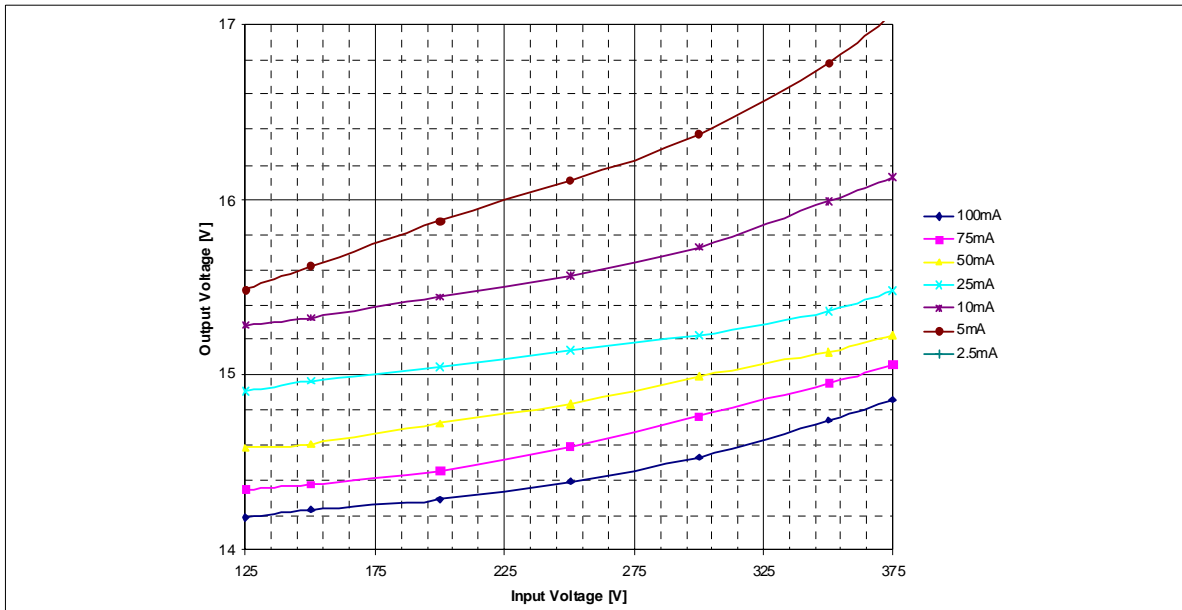

AN1894 - APPLICATION NOTE

Figure 25 depicts the dependency of the efficiency on the input voltage (parameter is output current) while Figure 26 shows the dependency on the output current (parameter is input voltage).

Figure 25: Efficiency variation with input voltage (Parameter is I_{out})

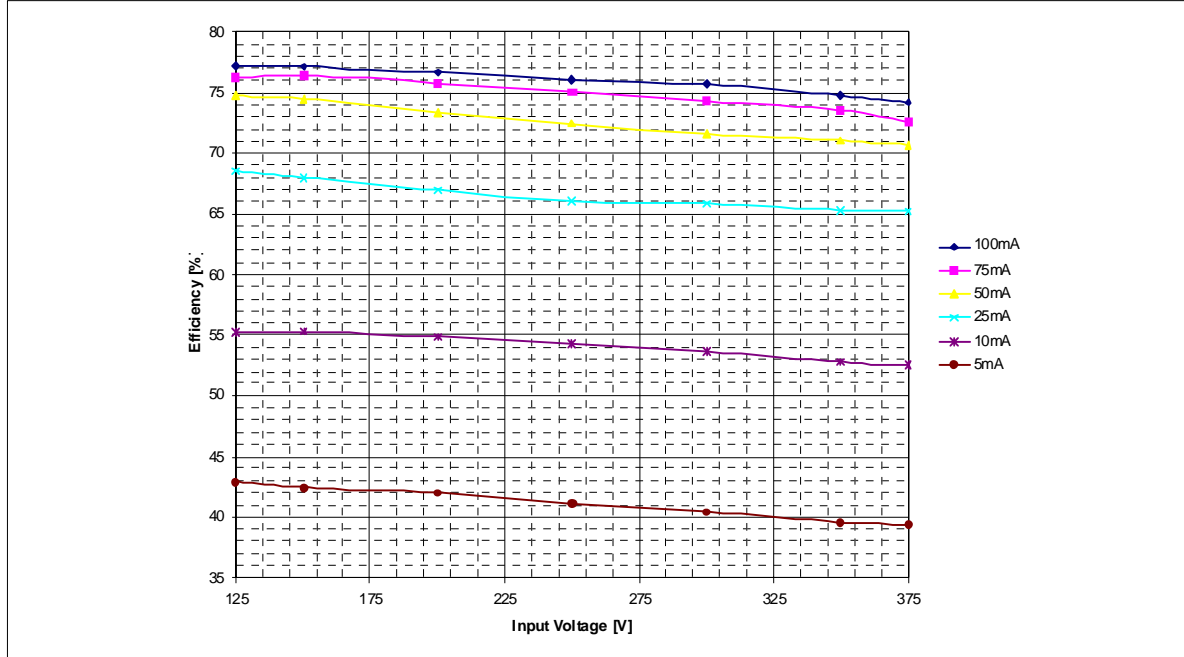
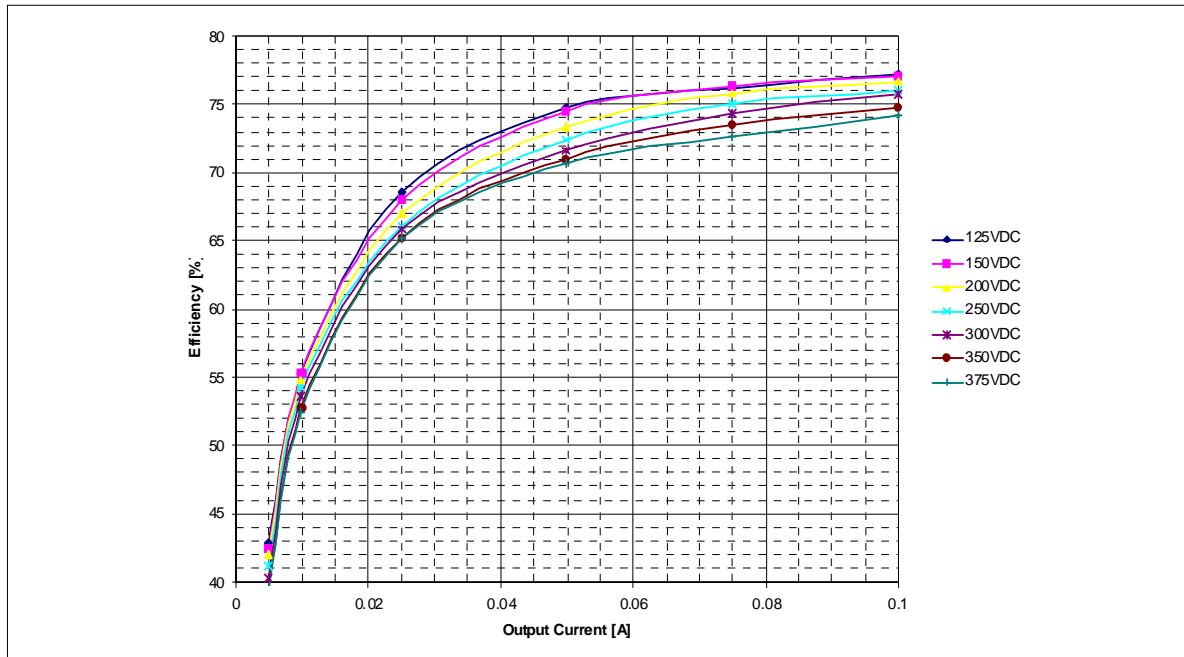

Figure 26: Efficiency variation with output current (Parameter is V_{in})



Following pictures starting from Figure 27 to Figure 34 show the most important voltage or current waveforms at different input and output conditions. The channel 1 (pink) is the power MOSFET Source terminal voltage of the VIPer12. The channel 4 (red) shows the inductor current. The purpose of those pictures is to demonstrate the skipping cycle function at light or no-load condition and cycle-by-cycle primary current limitation at overload or output shorted condition.

Figure 27: $V_{in}= 127\text{VDC}$, $I_{out}= 100\text{mA}$

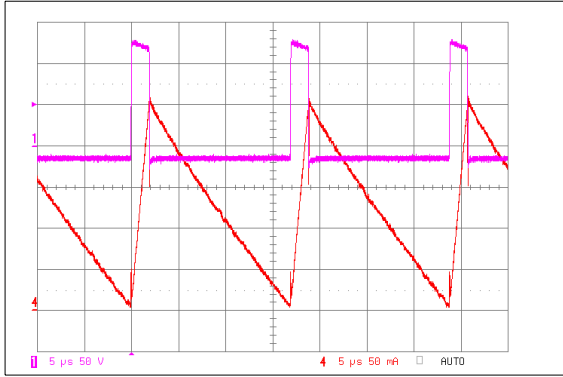

Figure 28: $V_{in}= 127\text{VDC}$, $I_{out}= 50\text{mA}$

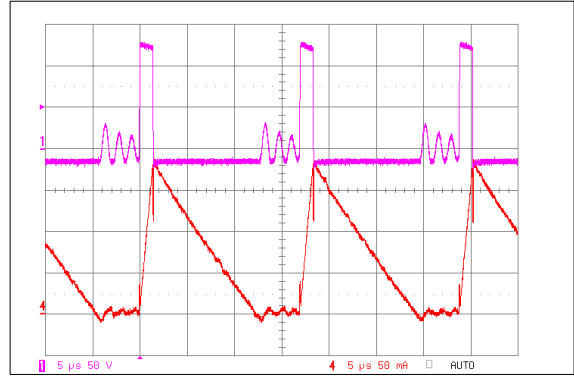

Figure 29: $V_{in}= 373\text{VDC}$, $I_{out}= 100\text{mA}$

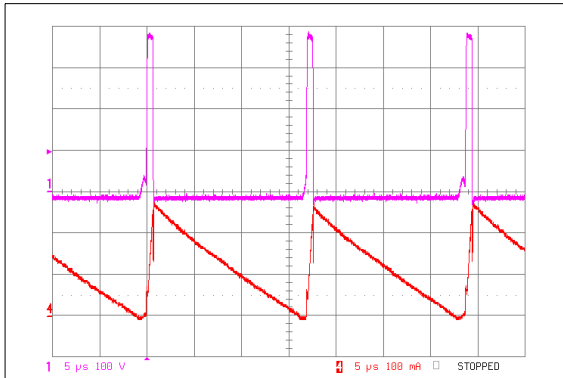

Figure 30: $V_{in}= 373\text{VDC}$, $I_{out}= 50\text{mA}$

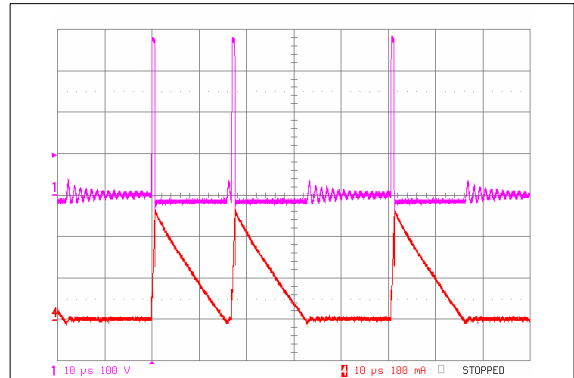

Figure 31: $V_{in}= 373\text{VDC}$, no-load

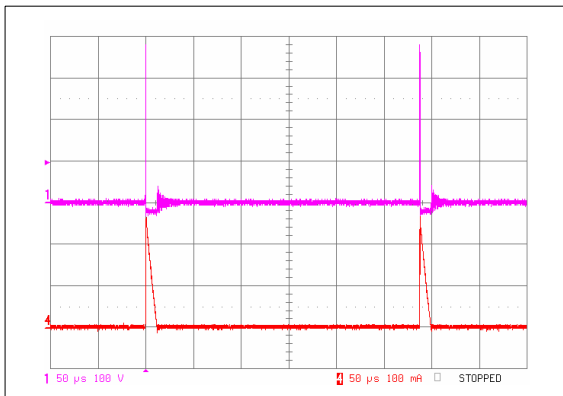
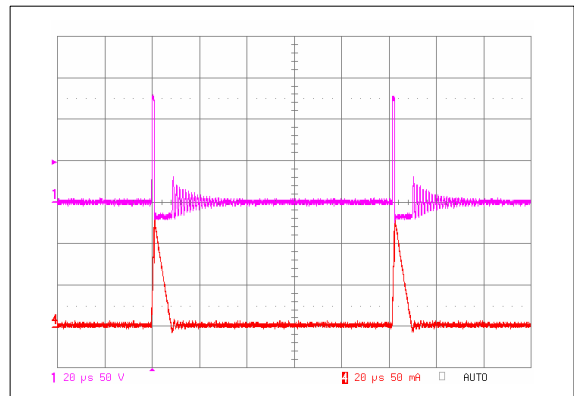

Figure 32: $V_{in}= 127\text{VDC}$, no-load



AN1894 - APPLICATION NOTE

Figure 33: $V_{in}= 127\text{VDC}$, output shorted

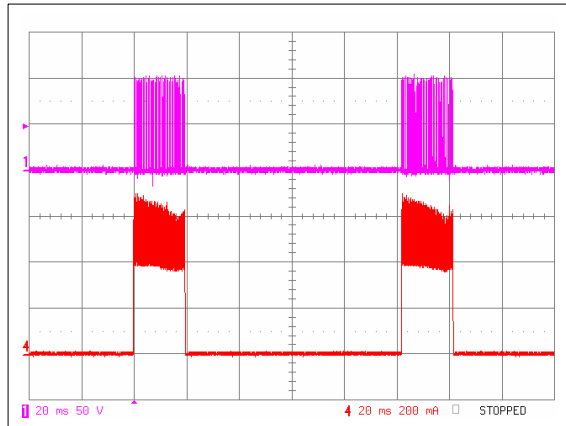
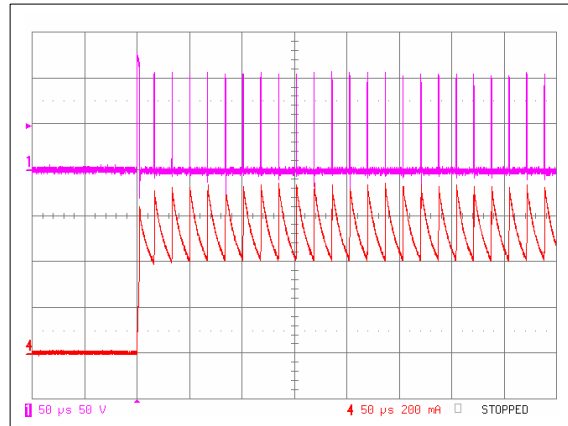

Figure 34: $V_{in}= 127\text{VDC}$, output shorted, burst magnified



Waveforms look very similar to those presented for the buck converter. One should notice the negative voltage present on the VIPer12 source after internal switch turn-off. The level of this negative voltage is equal to the output voltage level.

3. CONCLUSION

A reference board with the monolithic switcher VIPer12AS was presented. The way, how the reference board can be easily switched between two basic non-isolated topologies buck and buck-boost converter was described. Depicted output regulation and overall converter efficiency characteristics measured at different working conditions show good performance of this simple VIPer12AS application in such difficult working environment. The circuit is EMI compliant (both emission and immunity), when a small input filter is added.

Information furnished is believed to be accurate and reliable. However, STMicroelectronics assumes no responsibility for the consequences of use of such information nor for any infringement of patents or other rights of third parties which may result from its use. No license is granted by implication or otherwise under any patent or patent rights of STMicroelectronics. Specifications mentioned in this publication are subject to change without notice. This publication supersedes and replaces all information previously supplied. STMicroelectronics products are not authorized for use as critical components in life support devices or systems without express written approval of STMicroelectronics.

The ST logo is a trademark of STMicroelectronics

© 2004 STMicroelectronics - Printed in ITALY- All Rights Reserved.

STMicroelectronics GROUP OF COMPANIES

Australia - Brazil - Canada - China - Finland - France - Germany - Hong Kong - India - Israel - Italy - Japan - Malaysia - Malta - Morocco - Singapore - Spain - Sweden - Switzerland - United Kingdom - U.S.A.

<http://www.st.com>