

Protection of single battery voltage SLICs for new networks in US market

Introduction

Despite the widespread proliferation of digital technologies, analog networks remain the most commonly used telecommunication means in the world. Thanks to its simple and cheap technology, POTS (plain old telephone set) are still utilized extensively.

Figure 1. Schematic of new networks

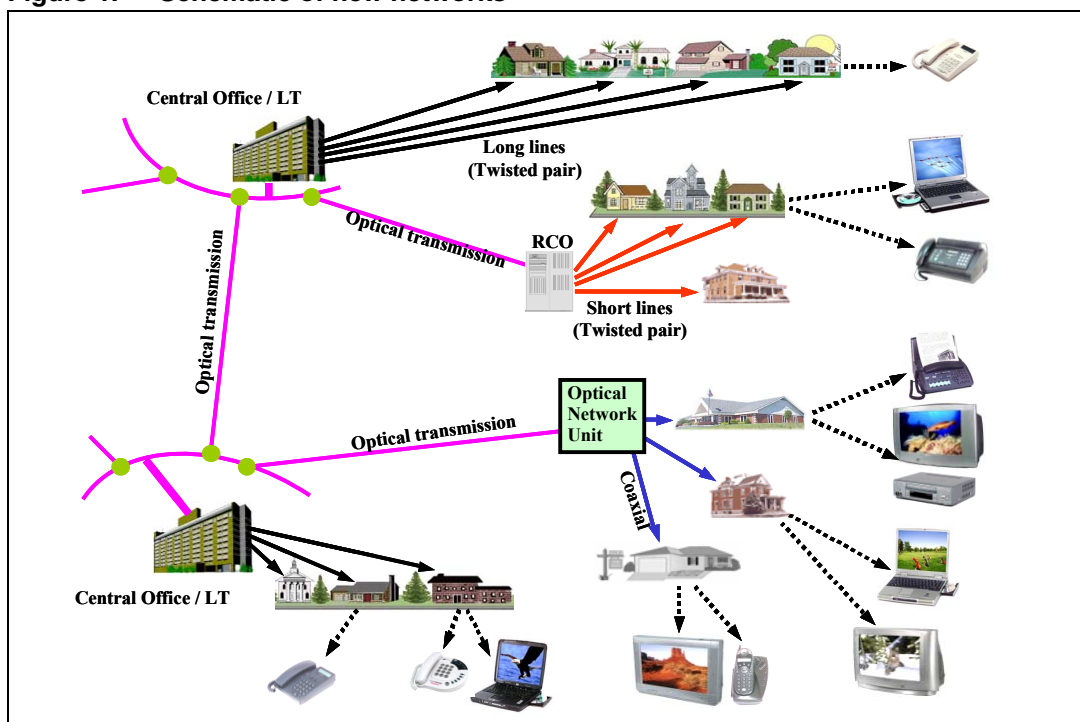

Figure 1 shows a schematic of modern telecom networks that are expected to keep growing. These networks are essentially made up of two kinds of lines, classical long lines (several kilometers long) that directly connect the Central Office (CO) to the subscriber, and short lines (few tens of meters in length) that connect Remote Central Offices (RCO), Optical Network Units (ONU) or Radio Network Units (RNU) to subscriber terminals. In these networks SLICs can be present in either conventional Central Offices or any of the above mentioned remote locations or in Remote Terminals (RT) in the customer premises which connect to POTS through short lines. The link between these remote locations and the CO is established by a long high speed digital link e.g. coaxial cable, fiber optic cable, Wireless Local Loop (WLL). This disparity in line length has given rise to SLICs of two types. Protection of both kinds of SLICs is a very important aspect in the design of the system. The purpose of this application note is to propose a complete protection solution for short line SLICs located in RT in customer premises.

Contents

Contents	2
1 Telecom disturbances	3
2 LCP152xx concept	5
3 SLIC protection	7
3.1 Lightning surge protection	9
3.2 Power crossing protection	12
4 Conclusion	15
5 Revision history	15

1 Telecom disturbances

Figure 2 shows the different disturbances that may appear on the telecom line. Among these, lightning and power crossing are the main considerations for wireline applications. These disturbances are well defined in the country standards.

Figure 2. Line disturbance causes

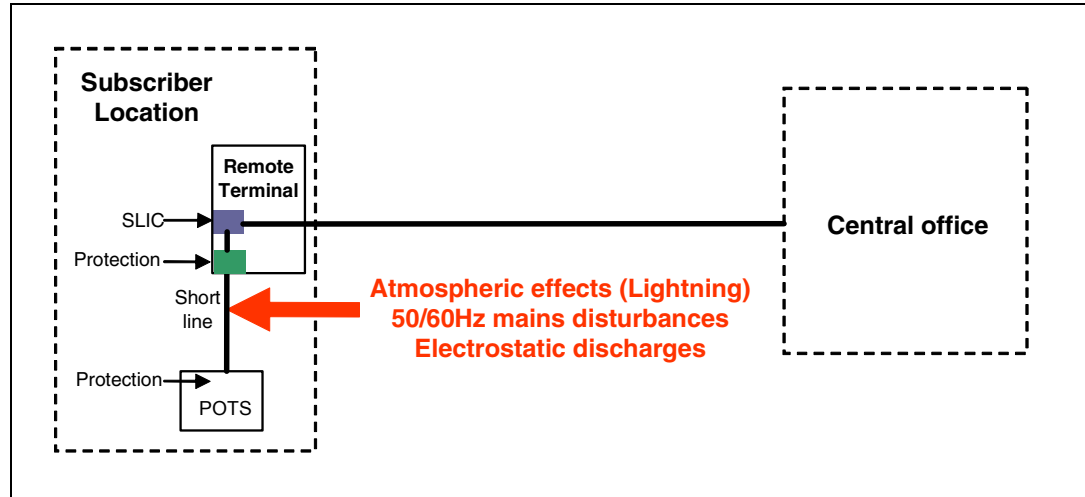

As the purpose of this application note is to illustrate the protection topology needed for short line SLICs located in RT in customer premises in the US, the standard to be considered for lightning and power crossing tests is the Telcordia GR1089 Intrabuilding (equipment port type 4).

The Telcordia GR1089 specifies two acceptance criteria:

- First level: the equipment shall continue to operate properly after the test.
- Second level: the equipment may be damaged, but should not become a fire or electrical hazard.

For intrabuilding equipment, however, only first level acceptance criterion need to be satisfied for lightning tests.

Table 1 and Table 2 give the list of lightning and power crossing tests in the Telcordia GR1089 intrabuilding standard for equipment port type 4.

Table 1. Telcordia GR1089 intrabuilding lightning tests

Surge	Peak voltage (V)	Peak current (A)	Voltage and current waveforms (µs)	Repetitions of each polarity	Test configuration ⁽¹⁾
1	±800	100	2/10	1	M (on tip and ring)
2	±1500	100	2/10	1	L

1. M: metallic; L: longitudinal

Table 2. Telcordia GR1089 2nd level intrabuilding power crossing test (equipment port type 4)

Test	Test for	Voltage (V _{rms})	Current (A _{rms})	Duration	Test configuration ⁽¹⁾
1	Secondary contact	120	25	15 minutes	M (on tip and ring), L

1. M: metallic; L: longitudinal

Table 3. IEC61000-4-2 ESD surge standard

Contact discharge		Air discharge	
Level	Test voltage (kV)	Level	Test voltage (kV)
1	2	1	2
2	4	2	4
3	6	3	8
4	8	4	15
X ⁽¹⁾	Special	X ⁽¹⁾	Special

1. "X" is a level to be defined.

Table 3 shows the most commonly used worldwide standard for ESD. Generally, Level 4 is required. Such tests appear in the Telcordia GR1089 standard and do apply to equipment port type 4.

The next section presents the protection concept of the LCP152xx used to protect short line SLICs with a single battery voltage.

2 LCP152xx concept

Figure 3. LCP152xx concept behavior

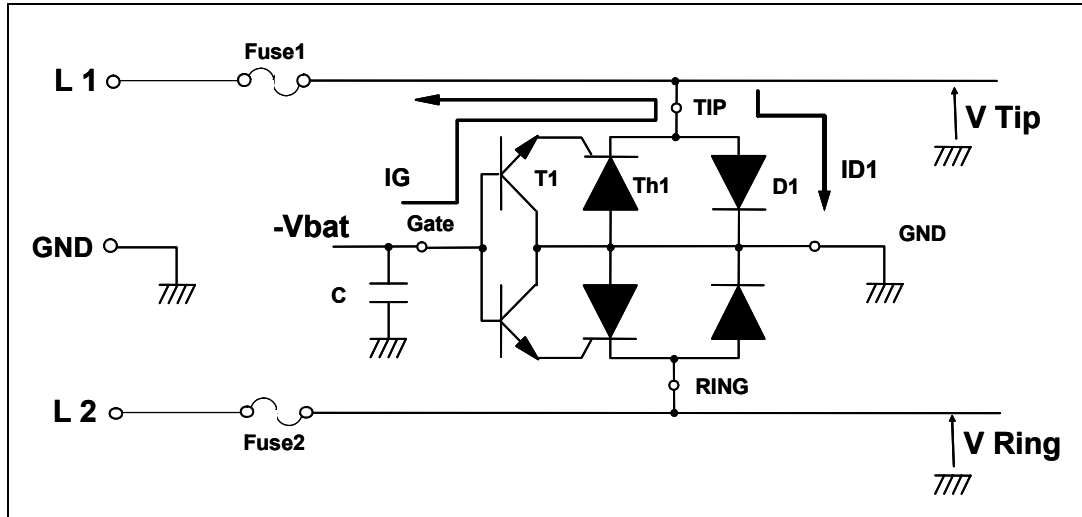
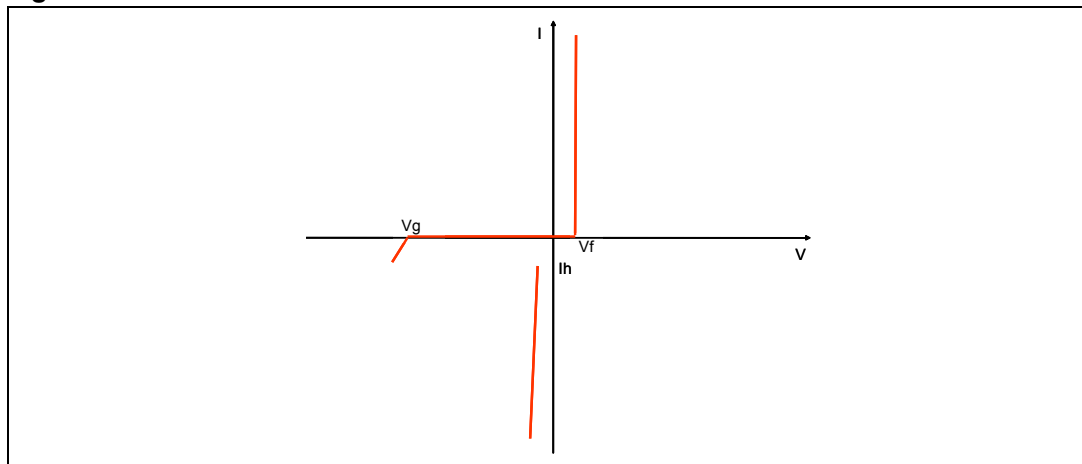

Figure 3 shows the protection circuit using the LCP152xx crowbar concept that can be used for protection of single battery high voltage SLICs. It's noteworthy that the schematic does not show series resistors that would normally be used on wires L1 and L2. This configuration permits the negative firing threshold V_g of the LCP152xx to be programmed at the negative battery voltage of the SLIC (up to -150 V), while the positive clamping threshold is at the GND.

Figure 4. LCP152xx electrical characteristics



It can be seen from the characteristics of the device (shown in Figure 4) that the device operates asymmetrically.

Under normal operating conditions i.e. when the voltage on the line is between 0 and $-V_{bat}$, the LCP152xx is transparent to the application.

For positive surges on either wire (e.g. L1), the diode D1 clamps the surge voltage to its forward voltage (V_f).

When there is a negative surge voltage bigger than $-V_{bat}$, on either wire (e.g. L1), a current I_G flows through the base of transistor T1 and is injected into the gate of thyristor Th1. This current causes Th1 to fire and the entire surge current is bypassed to GND. As soon as the surge current flowing through Th1 drops below the holding current I_h , Th1 switches off.

Figure 5. Example of recommended PCB layout for protection with LCP1521S

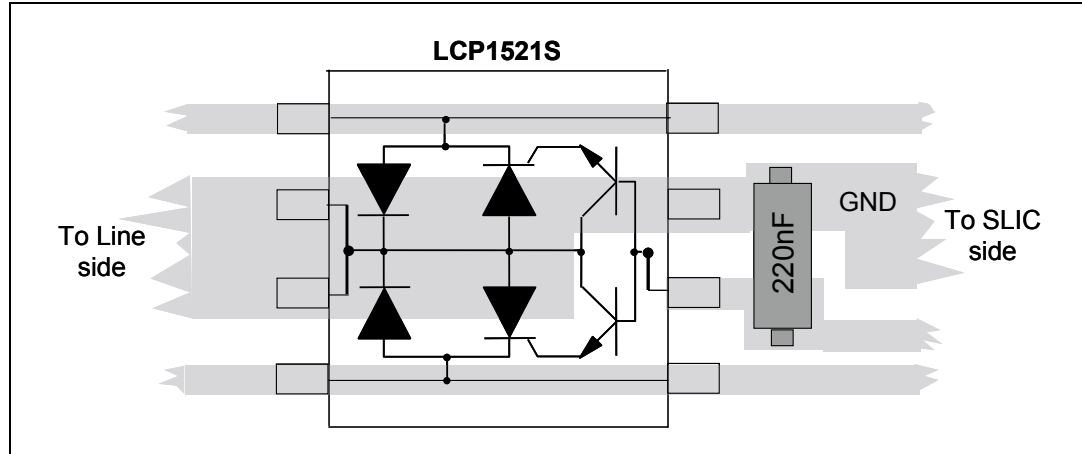

Figure 5 represents the PCB layout that would typically be used to optimize SLIC protection using LCP1521S which is in SO-8 package. The LCP152xx is also available in QFN 3x3 6 lead package, and is called LCP152DEE.

A capacitor is connected between the gate of the LCP1521S and the ground in order to speed up the firing of this device during fast edge surges. As shown in *Figure 5* the capacitor needs to be placed as close as possible to the LCP1521S gate pin and also to the reference ground track (or plane). Please note that the capacitor is generally present around the $-V_{bat}$ pin of the SLIC. The optimized value for the capacitor is 220 nF.

Such a layout is recommended for the QFN package as well.

Fuse1 and Fuse 2 in *Figure 3* are necessary in order for the equipment to be protected from power crossing disturbances. These are defined in the different country standards. The fuses shouldn't open for First level tests, while they must open safely for Second level tests where the LCP152xx will fail.

3 SLIC protection

Figure 6. Protection diagram for short line SLICs like STLC3055N located in remote terminals

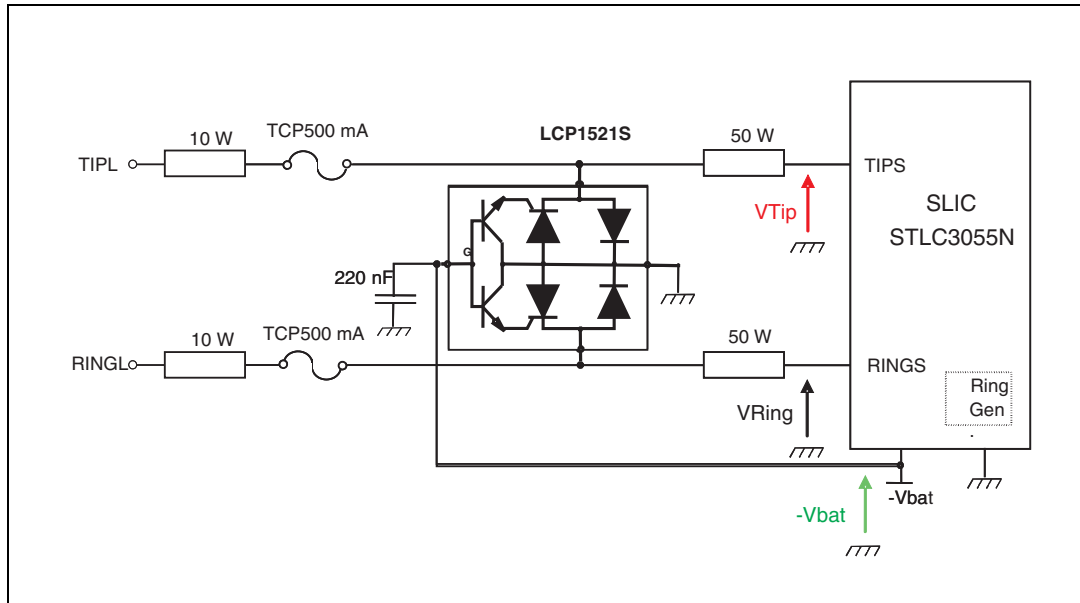

Figure 6 gives the protection circuit of a single battery voltage short line SLIC located in RT in the US. In this particular application note the STLC3055N has been chosen as an example of a single battery high voltage SLIC. High voltage SLICs like this, are well suited to short line applications that require smaller battery and ringing voltages, as compared to long line applications. Since the ringing signal is smaller, it is generated by the SLIC itself (without external ring generator). These SLICs are capable of higher voltages (~ -70 V during ringing) than classical long line SLICs (which generate ~ -56.6 V constant) and are therefore called high voltage SLICs.

At any given time the line card could be in one of three operating modes i.e. idle mode, ringing mode or speech mode. The protection circuit used must protect the line card during all three operating modes. During idle mode there is only the battery voltage on the line and when in speech or ringing mode the corresponding signal is superimposed on the battery voltage. The LCP1521S assumes this protection function for all three operating modes.

The fuse TCP500mA from Cooper-Bussman along with a 10Ω resistor is the serial protection used to protect the LCP1521S and the EUT against power crossing disturbances. The 50Ω resistor is used to limit the current entering the SLIC.

Figure 7. STLC3055N evaluation board used to perform tests

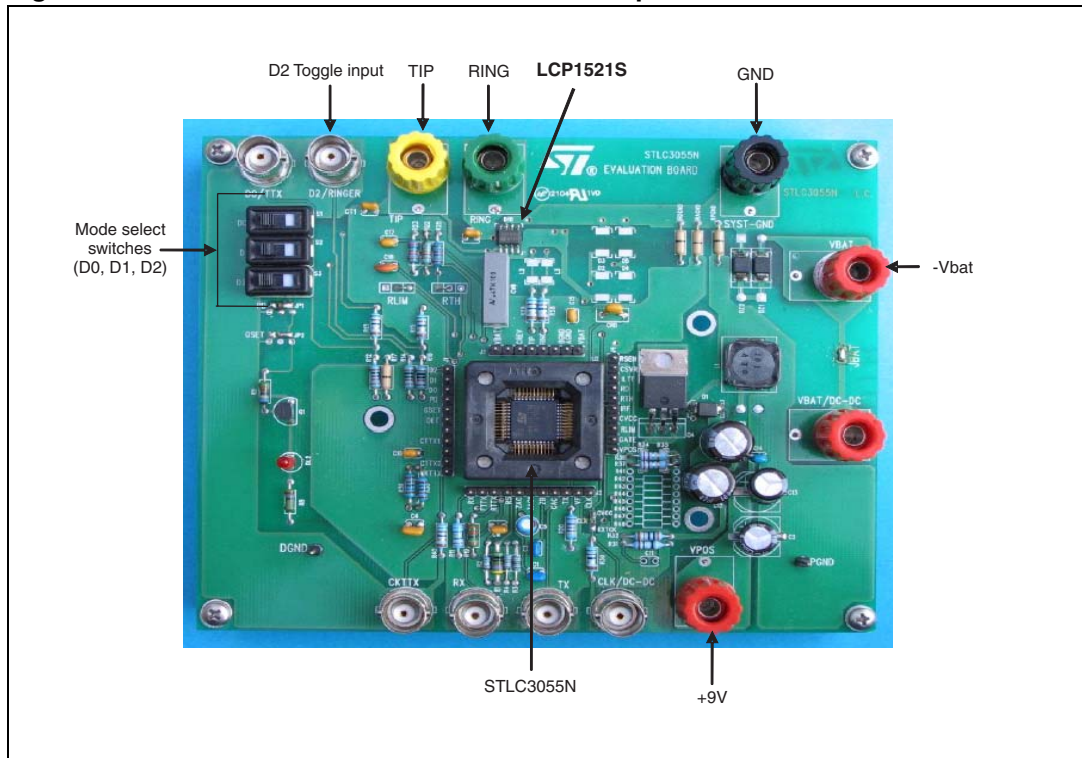

Figure 7 shows the STLC3055N evaluation board (Ref.:WT546) used to perform the tests. Please note that, as only lightning protection is managed on this board (by the LCP1521S), both fuses and 10 Ω resistors have to be added externally in order to assume protection against power crossing disturbances. The mode the SLIC operates in is selected by the mode select switches. These switches are single pole, double throw switches, that connect the pins D0, D1 or D2 to either Ground or V_{CC} i.e. logic level 0 or 1 respectively. The D2 toggle input is connected to a square wave at the ring frequency when the SLIC is in ringing mode. All the results shown here under were from tests performed on this board. The tests are performed only in Active mode Normal Polarity and Ringing mode as these two modes test the performance of the protection for both possible battery voltage levels.

Figure 8 shows the voltage on TIP, RING and $-V_{bat}$ during Active mode Normal Polarity where TIP is at -3.5V and RING is at -44.5 V ($-V_{bat} = -50.9$ V). The polarity can be reversed (i.e. TIP = -44.5 V and RING = -3.5 V) by switching D2. Figure 9 shows the TIP, RING and $-V_{bat}$ voltages in the Ringing mode. The voltage on each wire swings between -2.1 V and -66.4 V ($-V_{bat} = -70.9$ V) at the ring frequency of 20 Hz.

Figure 8. Tip, ring and $-V_{bat}$ voltages during active mode normal polarity (ANP mode)

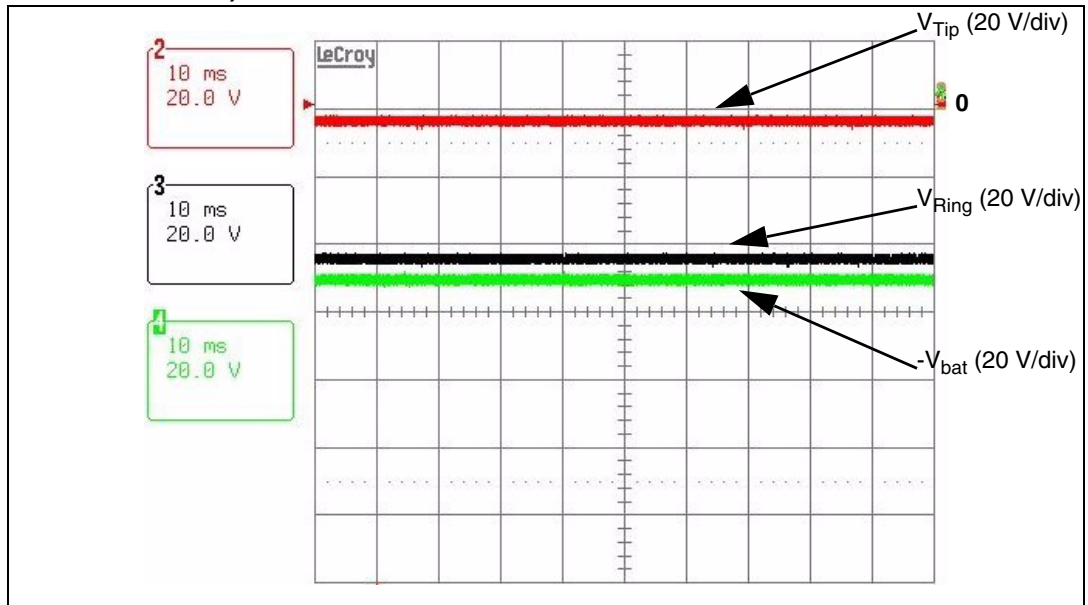
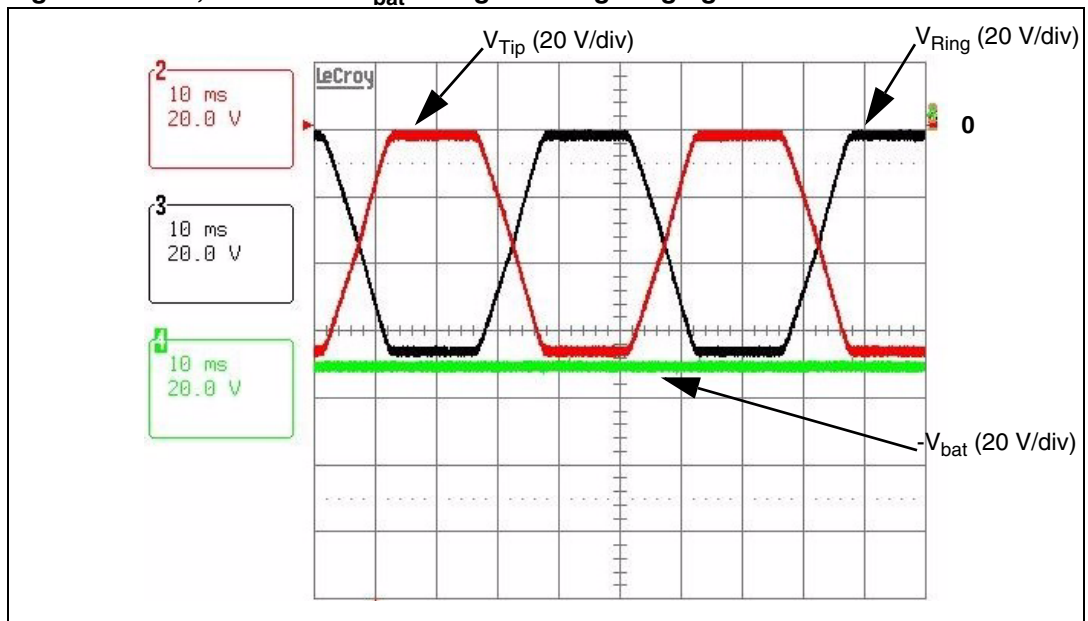

Figure 9. TIP, RING and $-V_{bat}$ voltages during Ringing mode



3.1 Lightning surge protection

Since the application is dedicated to US, the protection has to be Telcordia GR1089 compliant. Also because it is only meant for intrabuilding SLICs located in RT, this protection needs only to be able to handle a 100 A (2/10 μ s) current surge. Telcordia GR1089 Intrabuilding standard requires the EUT to meet First level compliance criterion for lightning tests.

Figure 10 shows the setup used to perform lightning tests in longitudinal mode. To perform lightning tests in metallic mode, the set up is similar except that one of the wires (TIP or RING) is connected to ground and the surge is applied only on the other wire.

Figure 10. Lightning measurement set up for longitudinal tests

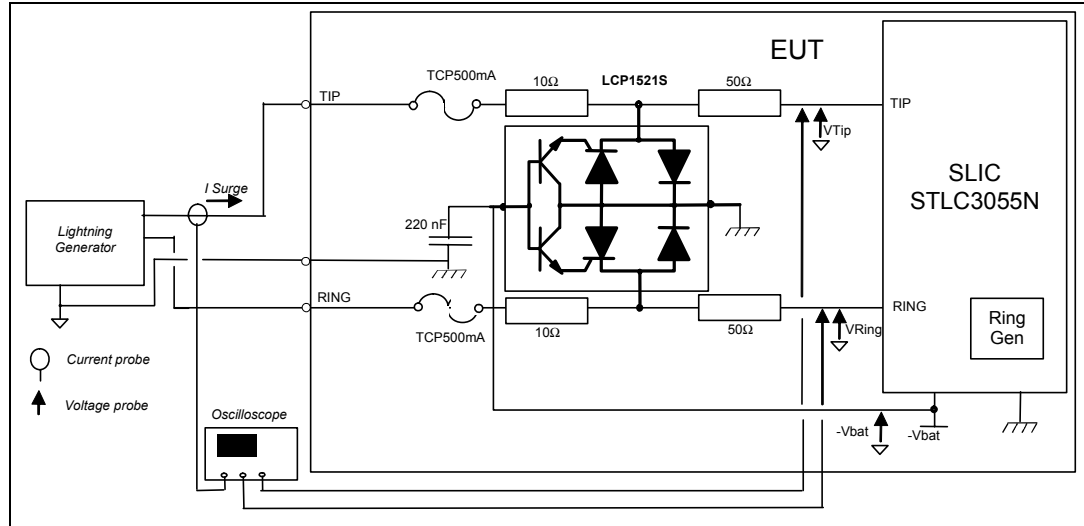

Figure 11. +800 V - 100 A (2/10 μs) - Metallic on ring - ringing mode

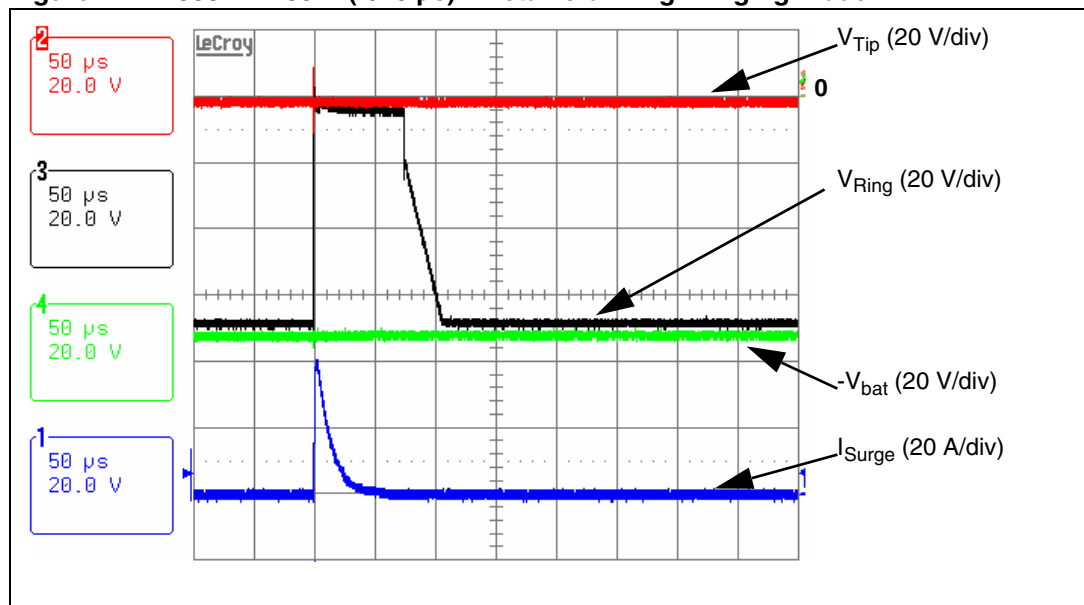

Figure 12. -800 V - 100 A (2/10 μ s) - Metallic on tip - ANP mode

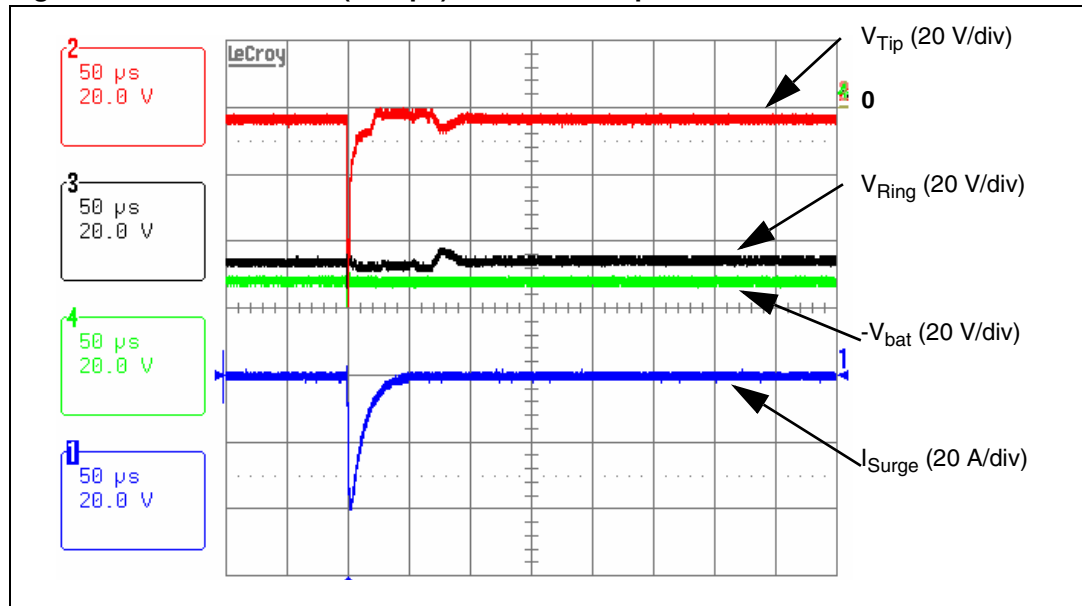

Figure 11 and Figure 12 show the behavior of the protection for positive and negative surges in Ringing mode and ANP mode respectively. The lightning surge is applied in metallic configuration and is 2/10 μ s – 800 V – 100 A per the Telcordia GR1089 Intrabuilding standard. In both cases it is seen that the peak current is only about 40 A. This is because of the two 10 Ω resistors on the line ($800\text{ V} / (8\ \Omega + 10\ \Omega) \sim 40\text{ A}$).

In the case of Figure 11 it is seen that the diode of the LCP1521S on the Ring wire clamps the voltage to GND when a positive surge is applied to RING. The protection behavior would be similar if the surge was applied on TIP. We also see that there is little effect of the surge on V_{Tip} and $-V_{bat}$. After the surge, V_{Ring} returns to the operating voltage.

Figure 12 shows that the thyristor structure inside the LCP1521S on the TIP wire fires when a negative surge of higher magnitude than $-V_{bat}$ is applied. When the current through the thyristor drops below its holding current, the voltage on TIP returns to the operating voltage.

Figure 13. +1500 V - 100 A (2/10 μ s) - longitudinal - ANP mode

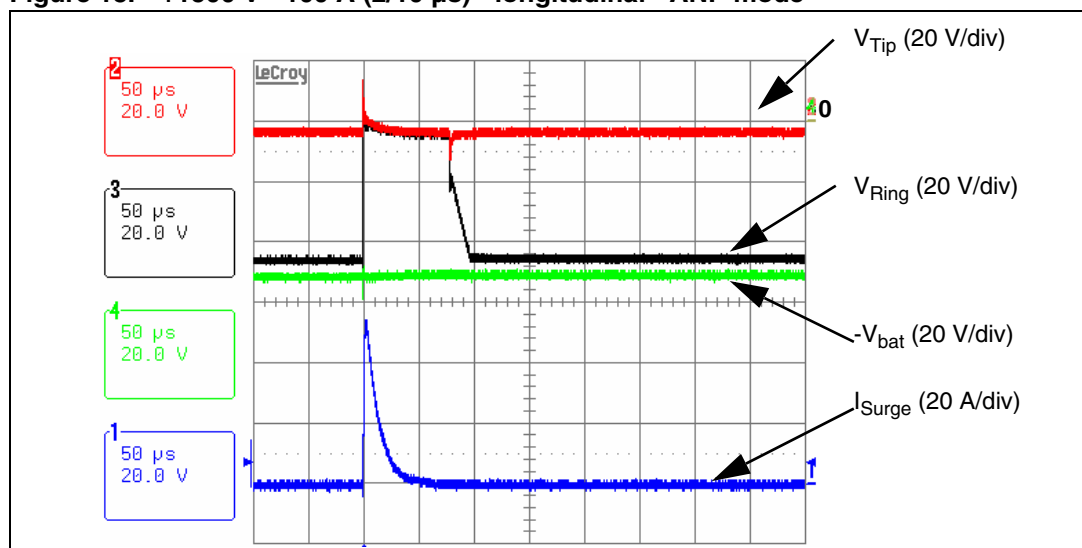

Figure 14. -1500 V - 100 A (2/10 μ s) - longitudinal - ringing mode

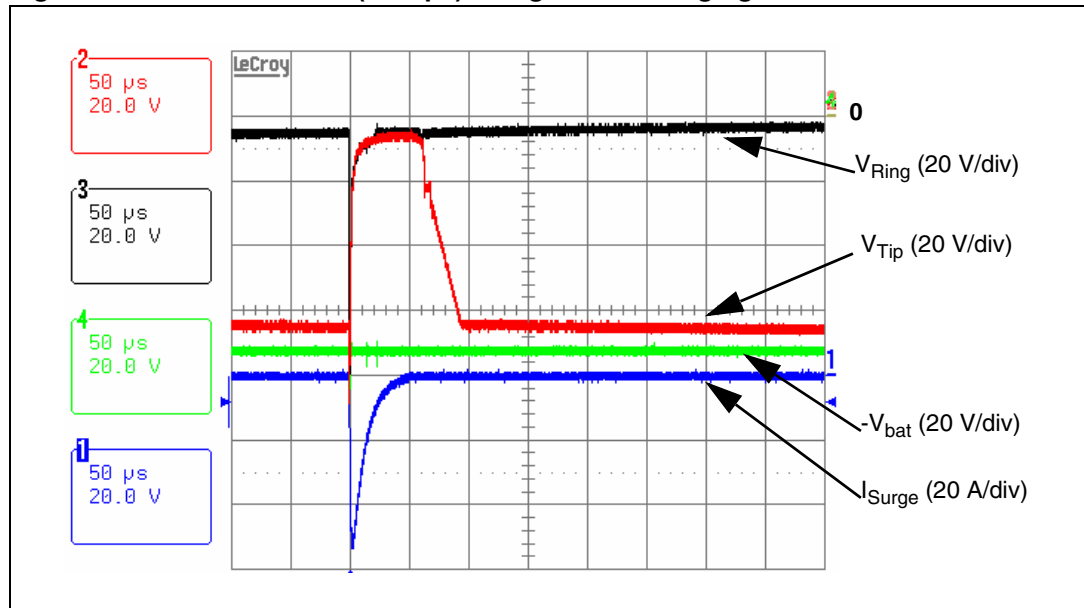

Figure 13 and Figure 14 also show the behavior of the protection for positive and negative surges in ANP mode and Ringing mode respectively. The lightning surge is applied in longitudinal configuration and is 2/10 μ s – 1500 V – 100 A per the Telcordia GR1089 Intrabuilding standard. In both cases it is seen that the peak current is only about 55 A. This is because of the two 10 Ω resistors on the line ($1500\text{ V} / (15\ \Omega + 10\ \Omega) \sim 55\text{ A}$).

The behavior of the protection for the 1500 V surge is the same as it is for the 800 V surge, the only difference being that the protection on both wires act, due to the longitudinal application of the pulse.

Although, the protection solution was tested for all lightning tests required by the Telcordia GR1089 Intrabuilding standard, for reasons of brevity, only some of them are illustrated above. All results are available upon request. The SLIC returned to its initial operating conditions after the surge application for all tests, i.e. the protection solution provides the SLIC, Telcordia GR1089 First level compliance.

3.2 Power crossing protection

The test setup used to perform the power crossing tests is exactly the same as the setup for lightning tests (shown in Figure 10 on page 10), with the AC surge generator connected instead of the lightning surge generator.

As seen in Table 2., the Telcordia GR1089 Intrabuilding standard requires the equipment (Port type 4) to meet Second level compliance criterion for 120 V_{rms} , 25 A_{rms} , 15 min power crossing test.

Figure 15. 120 V_{rms} - 25 A_{rms} - 15 min. - metallic on tip - ANP mode

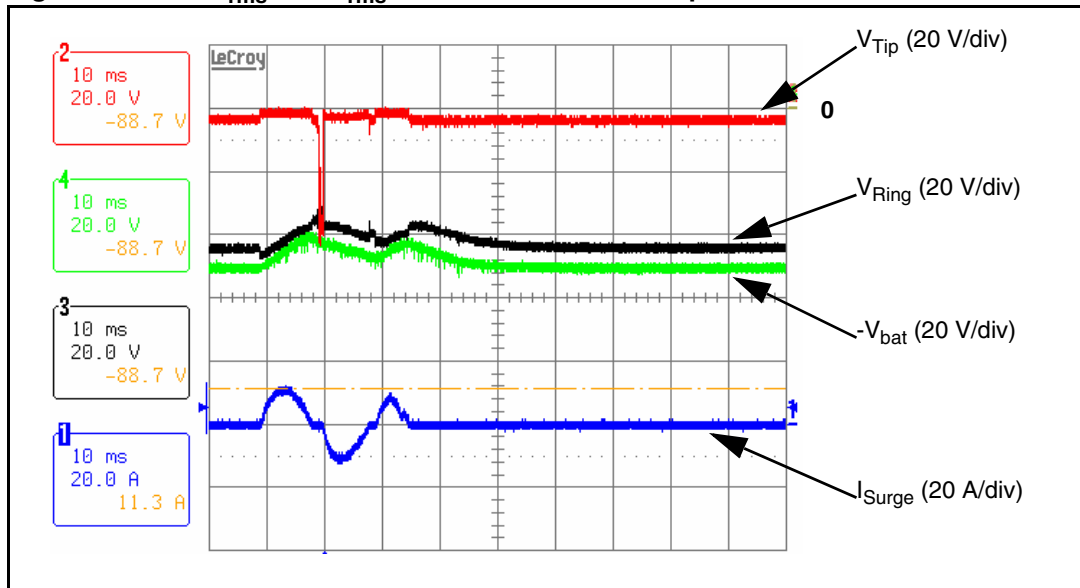

Figure 16. 120 V_{rms} - 25 A_{rms} - 15min. - longitudinal - ringing mode

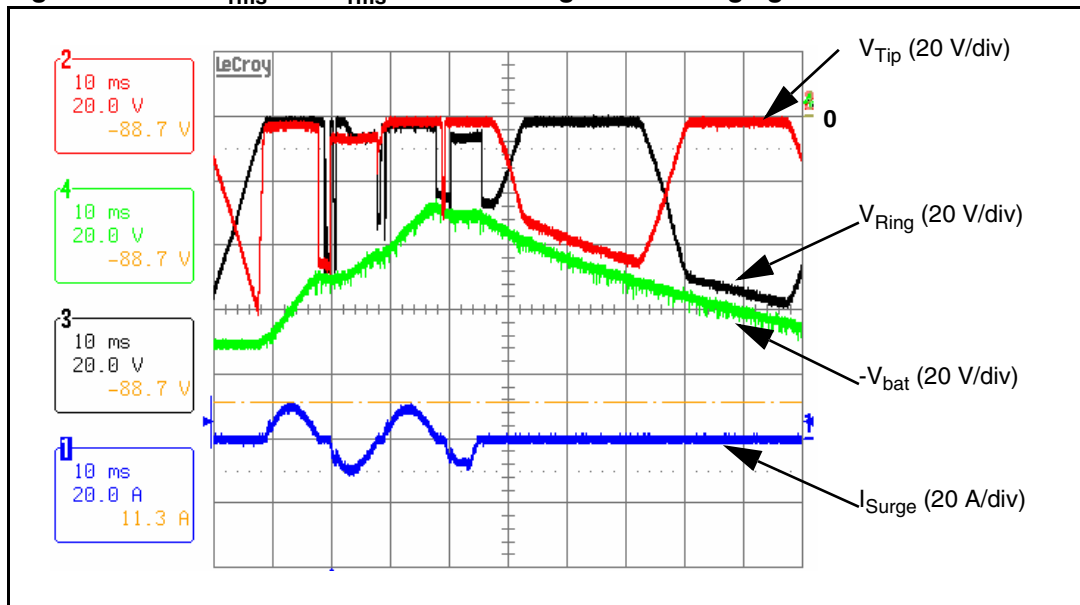

Figure 15 and Figure 16 show the protection behavior in ANP mode and Ringing mode when the power cross is applied in metallic configuration on TIP and in Longitudinal configuration respectively. The current is 11.3 A_{pk} ($120 \text{ V}_{\text{rms}} / (4.8 \Omega + 10 \Omega) \sim 8.1 \text{ A}_{\text{rms}} \sim 11.3 \text{ A}_{\text{pk}}$). It is seen that the power is engaged on the wire for 1.5 to 2 cycles before the fuse opens. During this time it is noted that the voltage is clamped to GND by the diode inside LCP1521S for the positive half cycles. During the negative half cycles, the thyristor structure inside LCP1521S fires when the voltage exceeds $-V_{\text{bat}}$. We see some disturbance in $-V_{\text{bat}}$ voltages but it returns to initial condition after the test. In Figure 15 the protection on Ring doesn't react because the power cross is only applied on TIP. But however there is a small disturbance on V_{Ring} during the surge due to the disturbance on $-V_{\text{bat}}$.

The protection solution was tested for all configurations, but only two are illustrated for brevity. All other test results are available upon request. The TCP 500 mA fuse opened safely in all cases (i.e. without smoke or fire) and ensured Telcordia GR1089 Second level compliance. There was no damage to the SLIC or even the LCP1521S after the power cross tests. Although not required by the Telcordia standard, this sort of co-ordination of serial and parallel protection reduces the system down time and keeps system recovery costs low after a power cross in the field.

4 Conclusion

The purpose of this application note was to propose a complete protection solution for single battery voltage SLICs located in remote terminals, at customer premises, in the US. Therefore, the standard that has been considered for lightning and power crossing tests in order to validate this protection solution is the Telcordia GR1089 Intrabuilding (equipment port type 4).

The protection solution consists of programmable overvoltage protection and fuses for overcurrent protection. The overvoltage protection device is an ST product based on the crowbar concept (LCP1521S). While the series protection is mainly done using fuses TCP 500 mA from Cooper-Bussman. There is a 10 Ω resistor on each wire that makes the fuses TCP500mA compatible with the LCP1521S and makes the solution compliant with the Telcordia GR1089 Intrabuilding standard.

All the tests mentioned in the tables of the Telcordia GR1089 Intrabuilding standard were performed on the STLC3055N evaluation board shown in [Figure 7 on page 8](#), with both external fuses and 10 Ω resistors. All test results are available upon request. These results showed that there was no impact on either of the fuses during lightning tests, while they opened safely, in time to protect the SLIC and the LCP1521S, during power crossing tests.

The presented protection topology is an effective protection solution for single battery voltage SLICs located at remote terminals in the US. The application note is intended only as a guideline. While the STLC3055N is a good example of a single battery voltage SLIC that one might see in a remote terminal, SLIC designs are excessively variant and therefore exact implementation of the above circuitry for a different SLIC may or may not be the most efficient solution.

5 Revision history

Date	Revision	Changes
03-Nov-2006	1	Initial release.

Please Read Carefully:

Information in this document is provided solely in connection with ST products. STMicroelectronics NV and its subsidiaries ("ST") reserve the right to make changes, corrections, modifications or improvements, to this document, and the products and services described herein at any time, without notice.

All ST products are sold pursuant to ST's terms and conditions of sale.

Purchasers are solely responsible for the choice, selection and use of the ST products and services described herein, and ST assumes no liability whatsoever relating to the choice, selection or use of the ST products and services described herein.

No license, express or implied, by estoppel or otherwise, to any intellectual property rights is granted under this document. If any part of this document refers to any third party products or services it shall not be deemed a license grant by ST for the use of such third party products or services, or any intellectual property contained therein or considered as a warranty covering the use in any manner whatsoever of such third party products or services or any intellectual property contained therein.

UNLESS OTHERWISE SET FORTH IN ST'S TERMS AND CONDITIONS OF SALE ST DISCLAIMS ANY EXPRESS OR IMPLIED WARRANTY WITH RESPECT TO THE USE AND/OR SALE OF ST PRODUCTS INCLUDING WITHOUT LIMITATION IMPLIED WARRANTIES OF MERCHANTABILITY, FITNESS FOR A PARTICULAR PURPOSE (AND THEIR EQUIVALENTS UNDER THE LAWS OF ANY JURISDICTION), OR INFRINGEMENT OF ANY PATENT, COPYRIGHT OR OTHER INTELLECTUAL PROPERTY RIGHT.

UNLESS EXPRESSLY APPROVED IN WRITING BY AN AUTHORIZED ST REPRESENTATIVE, ST PRODUCTS ARE NOT RECOMMENDED, AUTHORIZED OR WARRANTED FOR USE IN MILITARY, AIR CRAFT, SPACE, LIFE SAVING, OR LIFE SUSTAINING APPLICATIONS, NOR IN PRODUCTS OR SYSTEMS WHERE FAILURE OR MALFUNCTION MAY RESULT IN PERSONAL INJURY, DEATH, OR SEVERE PROPERTY OR ENVIRONMENTAL DAMAGE. ST PRODUCTS WHICH ARE NOT SPECIFIED AS "AUTOMOTIVE GRADE" MAY ONLY BE USED IN AUTOMOTIVE APPLICATIONS AT USER'S OWN RISK.

Resale of ST products with provisions different from the statements and/or technical features set forth in this document shall immediately void any warranty granted by ST for the ST product or service described herein and shall not create or extend in any manner whatsoever, any liability of ST.

ST and the ST logo are trademarks or registered trademarks of ST in various countries.

Information in this document supersedes and replaces all information previously supplied.

The ST logo is a registered trademark of STMicroelectronics. All other names are the property of their respective owners.

© 2006 STMicroelectronics - All rights reserved

STMicroelectronics group of companies

Australia - Belgium - Brazil - Canada - China - Czech Republic - Finland - France - Germany - Hong Kong - India - Israel - Italy - Japan - Malaysia - Malta - Morocco - Singapore - Spain - Sweden - Switzerland - United Kingdom - United States of America

www.st.com