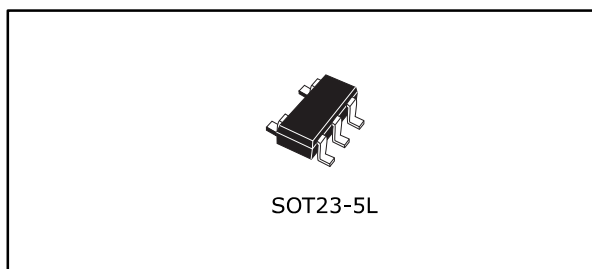

150 mA, ultra low quiescent current linear voltage regulator

Datasheet - production data

**Features**

- Input voltage from 1.5 to 5.5 V
- Very low quiescent current:
 - 1.0 μ A (typ.) at no load
 - 1.4 μ A (typ.) at 150 mA load
 - 1 nA (typ.) in OFF mode
 - 200 nA max. in OFF mode at 125 °C
- Output voltage tolerance: \pm 2% at 25 °C
- 150 mA guaranteed output current
- Wide range of output voltages: 0.8 V to 3.3 V in 100 mV steps
- Logic-controlled electronic shutdown
- Compatible with ceramic capacitor ($C_{OUT} = 1 \mu$ F)
- Internal current and thermal limit
- Temperature range: from -40 °C to 125 °C

Application

- Mobile phones
- Digital still cameras (DSC)
- Battery-powered equipment
- Portable media players

Description

The STLQ015 provides 150 mA of maximum current with an input voltage range from 1.5 V to 5.5 V and a typical dropout voltage of 112 mV. The key feature of this device is its quiescent current, which is just 1.4 μ A at maximum output current. The device is stable with a ceramic capacitor on the output. It offers very low quiescent current and extends battery-life of applications requiring very long standby time. The enable logic control function puts the STLQ015 in shutdown mode, reducing total current consumption to 1 nA. The device also includes short-circuit constant-current limiting and thermal protection. Typical applications are: portable and battery-powered systems, electronic sensors and microcontroller power supply.

Contents

1	Block diagram.....	3
2	Pin configuration and description.....	4
3	Typical application	5
4	Maximum ratings	6
5	Electrical characteristics	7
6	Typical performance characteristics	9
7	Package information	12
	7.1 SOT23-5L package information	12
	7.2 SOT23-5L packing information.....	14
8	Ordering information.....	15
9	Revision history	16

1 Block diagram

Figure 1: Device block diagram

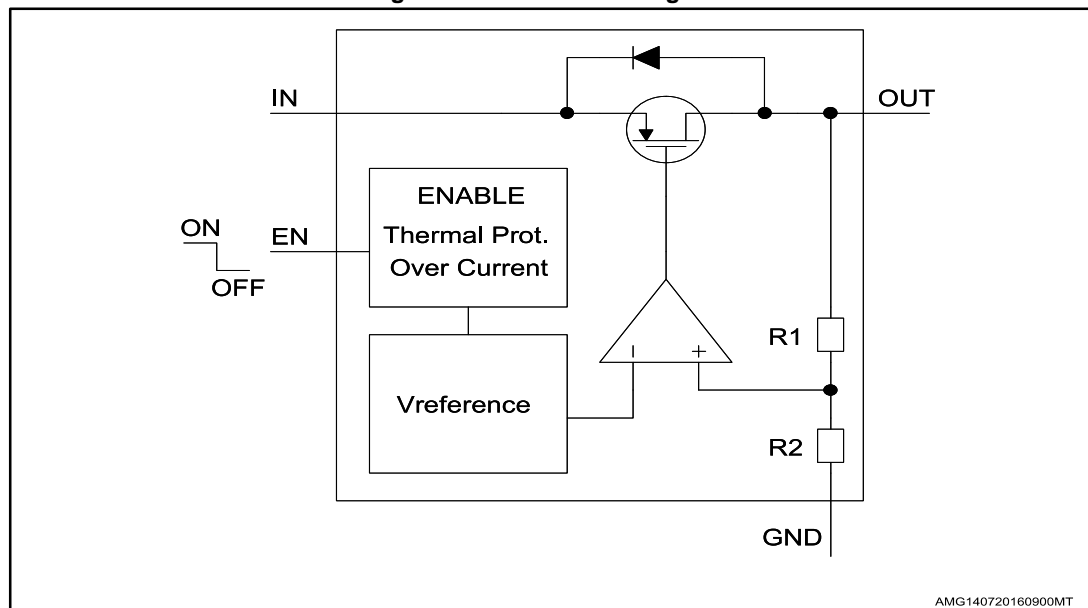

2 Pin configuration and description

Figure 2: Pin configuration (top view)

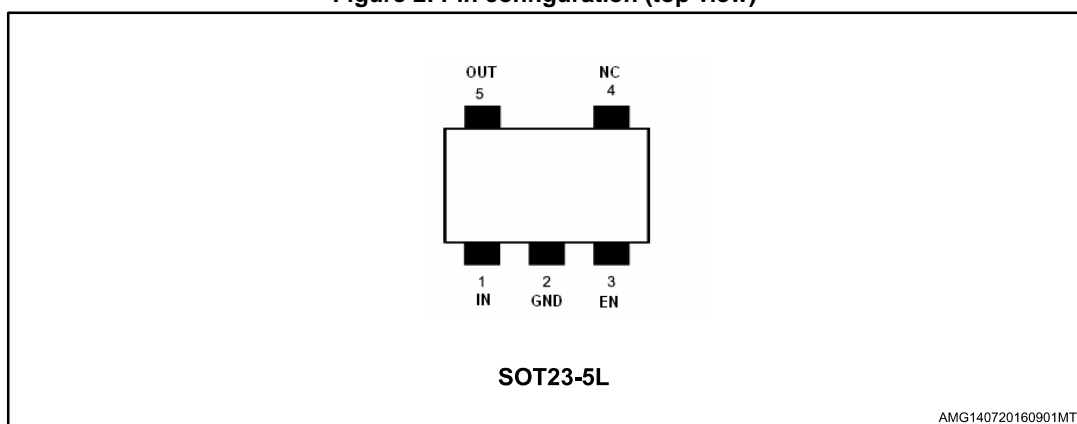
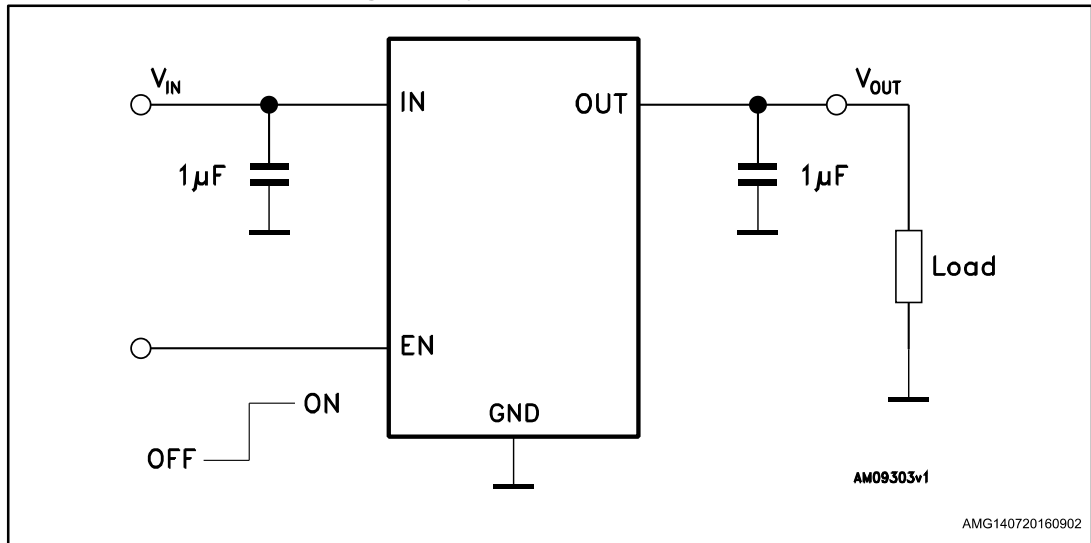

Table 1: Pin description

Pin	Symbol	Functions
3	EN	Enable input Set V_{EN} = high to turn on the device Set V_{EN} = low to turn off the device
2	GND	Ground
1	IN	Input voltage
5	OUT	Output voltage
4	NC	Not connected

3 Typical application

Figure 3: Typical application circuit



4 Maximum ratings

Table 2: Absolute maximum ratings

Symbol	Parameter	Value	Unit
V _{IN}	DC input voltage	-0.3 to 7	V
V _{OUT}	DC output voltage	-0.3 to V _{IN} +0.3	V
V _{EN}	Enable input voltage	-0.3 to V _{IN} +0.3	V
I _{OUT}	Output current	Internally limited	mA
ESD	Human body model	±3	kV
	Machine model	±300	V
P _D	Power dissipation	Internally limited	mW
T _{STG}	Storage temperature range	-65 to 150	°C
T _{OP}	Max. junction temperature	150	°C



Absolute maximum ratings are those values beyond which damage to the device may occur. Functional operation under these conditions is not implied. All values are referred to GND.

Table 3: Thermal data

Symbol	Parameter	Value	Unit
R _{thJA}	Thermal resistance junction-ambient	255	°C/W
R _{thJC}	Thermal resistance junction-case	81	°C/W

5 Electrical characteristics

$T_J = 25\text{ °C}$, $V_{IN} = V_{OUT(NOM)} + 1\text{ V}$, $C_{IN} = C_{OUT} = 1\text{ }\mu\text{F}$, $I_{OUT} = 1\text{ mA}$, $V_{EN} = V_{IN}$, unless otherwise specified.

Table 4: Electrical characteristics

Symbol	Parameter	Test conditions	Min.	Typ.	Max.	Unit
V_{IN}	Operating input voltage	$I_{OUT} = 0$	1.5		5.5	V
		$-40\text{ °C} < T_J < 125\text{ °C}$, $I_{OUT} = 150\text{ mA}$	1.55		5.5	
V_{OUT}	V_{OUT} accuracy	$I_{OUT} = 1\text{ mA}$	-2		2	%
		$I_{OUT} = 1\text{ mA}$, $V_{OUT} < 1\text{ V}$	-20		+20	mV
		$I_{OUT} = 1\text{ mA}$, $-40\text{ °C} < T_J < 125\text{ °C}$	-3		3	%
$\Delta V_{OUT-LINE}$	Static line regulation	$V_{OUT} + 1\text{ V} \leq V_{IN} \leq 5.5\text{ V}$, $I_{OUT} = 1\text{ mA}$		± 0.01		%/V
$\Delta V_{OUT-LOAD}$	Static load regulation	$I_{OUT} = 1\text{ mA}$ to 150 mA		± 0.002		%/mA
V_{DROP}	Dropout voltage ⁽¹⁾	$I_{OUT} = 150\text{ mA}$		112		mV
		$I_{OUT} = 150\text{ mA}$, $-40\text{ °C} < T_J < 125\text{ °C}$			300	
e_n	Output noise voltage	10 kHz to 100 kHz, $I_{OUT} = 10\text{ mA}$, $V_{OUT} = 0.8\text{ V}$		75		μV_{RMS}
SVR	Supply voltage rejection $V_{OUT} = 0.8\text{ V}$	$V_{IN} = V_{OUTNOM} + 1\text{ V} \pm V_{RIPPLE}$ $V_{RIPPLE} = 0.1\text{ V}$, frequency = 1 kHz $I_{OUT} = 10\text{ mA}$		40		dB
		$V_{IN} = V_{OUTNOM} + 1\text{ V} \pm V_{RIPPLE}$ $V_{RIPPLE} = 0.1\text{ V}$, frequency = 10 kHz $I_{OUT} = 1\text{ mA}$		30		
		$V_{IN} = V_{OUTNOM} + 1\text{ V} \pm V_{RIPPLE}$ $V_{RIPPLE} = 0.1\text{ V}$, frequency = 100 kHz $I_{OUT} = 1\text{ mA}$		15		
I_q	Quiescent current	$I_{OUT} = 0$		1.0	1.7	μA
		$I_{OUT} = 0$ to 150 mA , $-40\text{ °C} < T_J < 125\text{ °C}$		1.4	2.4	
I_{OFF}	Shutdown current ⁽²⁾	V_{IN} input current in OFF mode: $V_{EN} = \text{GND}$, $-40\text{ °C} < T_J < 125\text{ °C}$		1	200	nA
I_{SC}	Short-circuit current	$R_L = 0$	250	350		mA
V_{EN}	Enable input logic low	$V_{IN} = 1.5\text{ V}$ to 5.5 V			0.4	V
	Enable input logic high	$V_{IN} = 1.5\text{ V}$ to 5.5 V	0.7			V

Electrical characteristics
STLQ015

Symbol	Parameter	Test conditions	Min.	Typ.	Max.	Unit
I_{EN}	Enable pin input current	$V_{EN} = 5.5 \text{ V}$		1	200	nA
T_{ON}	Turn-on time ⁽³⁾	$V_{OUT} = 0.8 \text{ V}$, $I_{OUT} = 150 \text{ mA}$		160		μs
T_{SHDN}	Thermal shutdown			170		$^{\circ}\text{C}$
	Hysteresis			15		
C_{OUT}	Output capacitor	Capacitance (see typical performance characteristics for stability)	0.47		10	μF
	ESR		0.056		6	Ω

Notes:

⁽¹⁾Dropout voltage is the input-to-output voltage difference at which the output voltage is 100 mV below its nominal value. This specification does not apply to output voltages below 1.5 V.

⁽²⁾During shutdown and at no load, P-channel leakage current flowing through the internal resistor divider causes the V_{OUT} rise.

⁽³⁾Turn-on time is the time measured between the enable input just exceeding V_{EN} high value and the output voltage just reaching 95% of its nominal value.

6 Typical performance characteristics

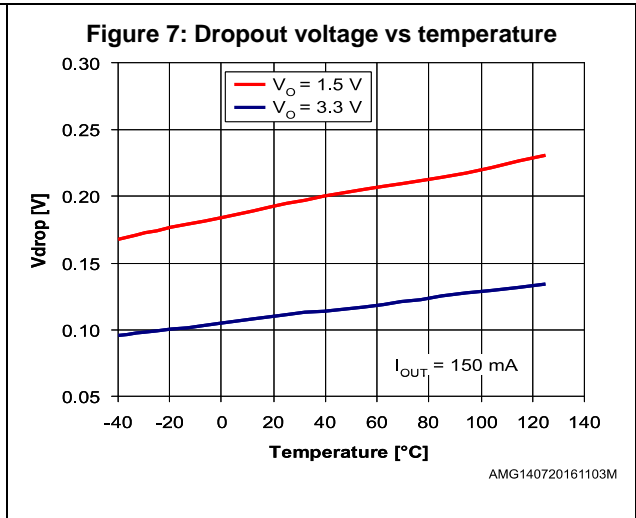
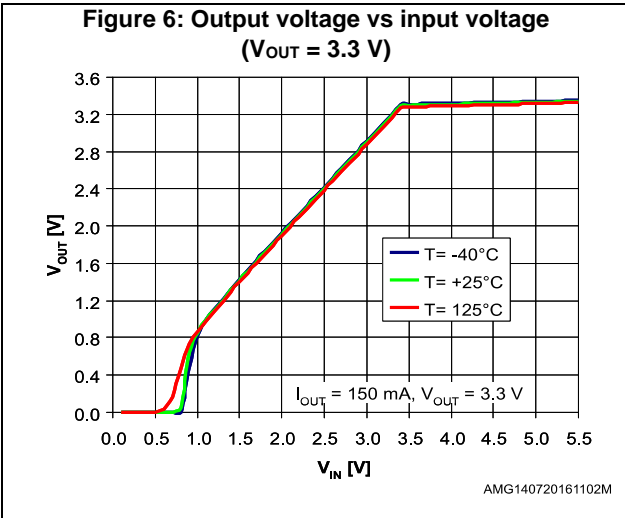
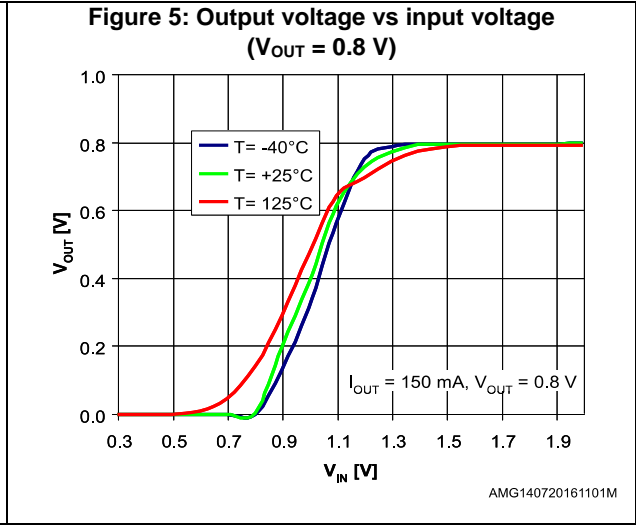
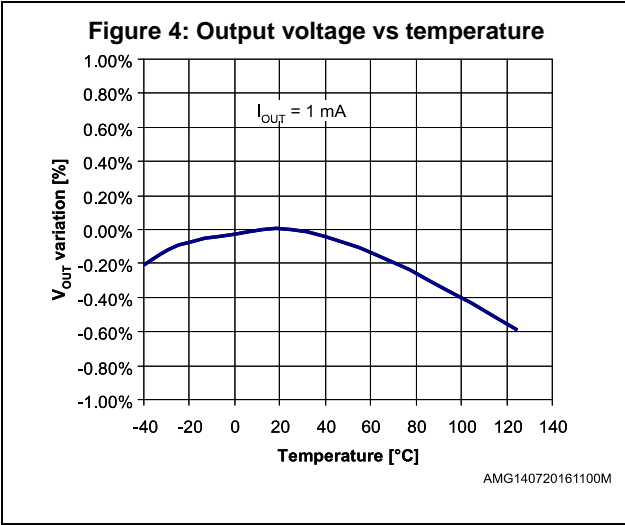

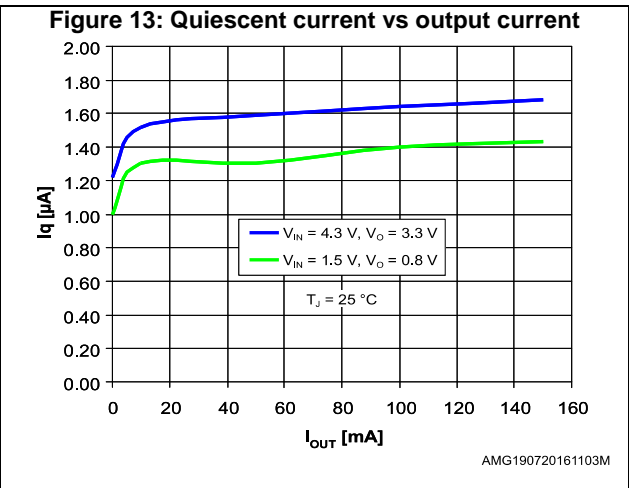
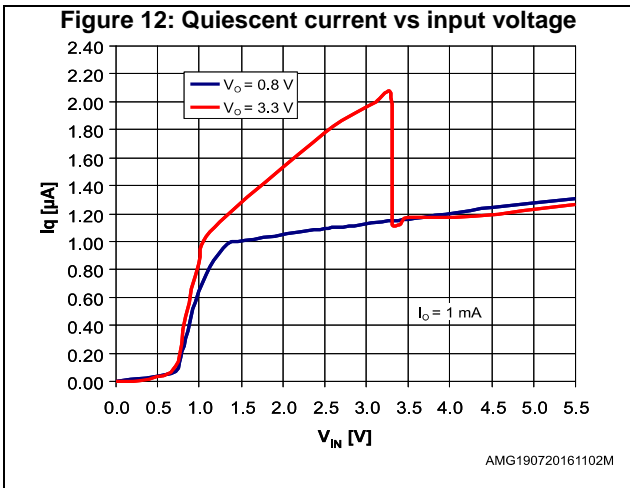
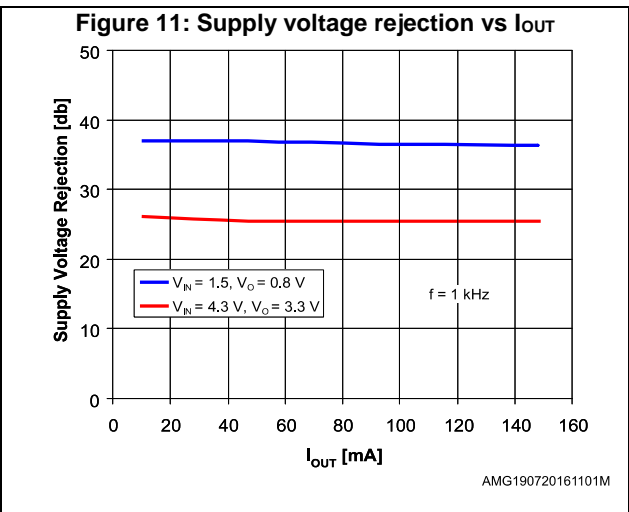
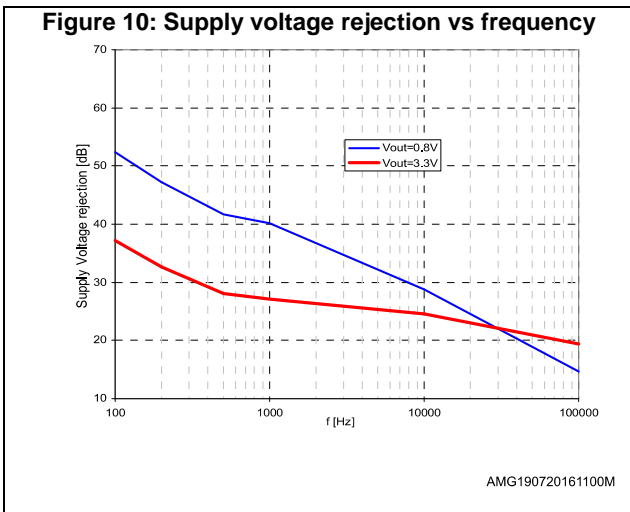
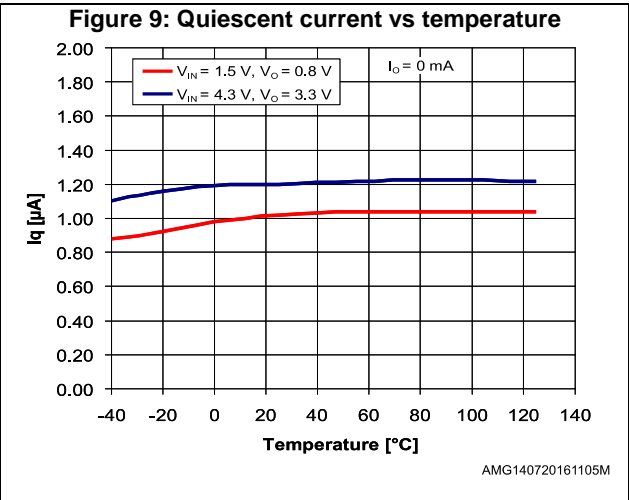
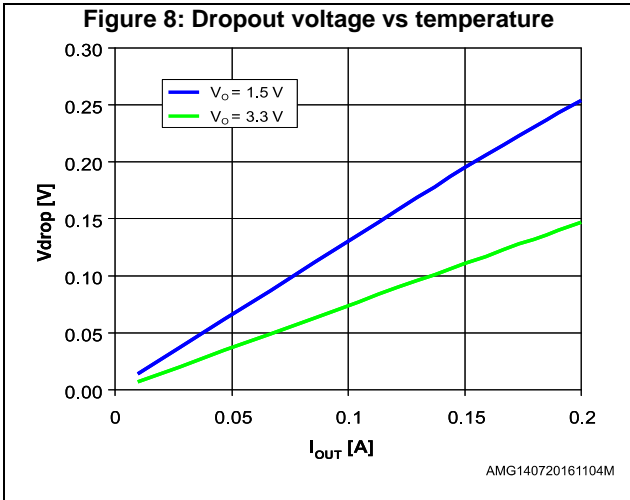

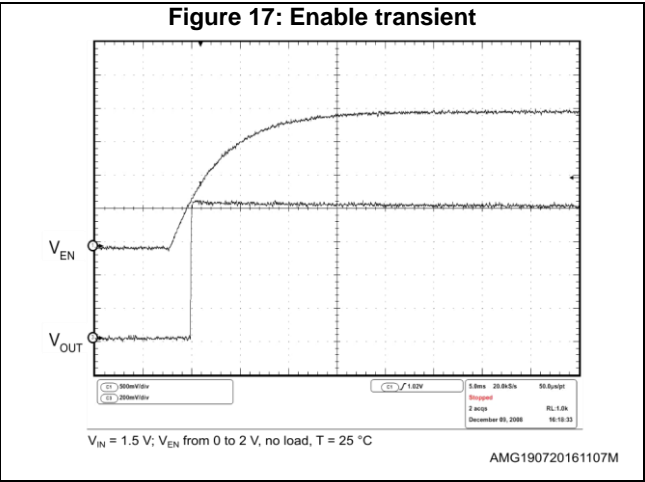
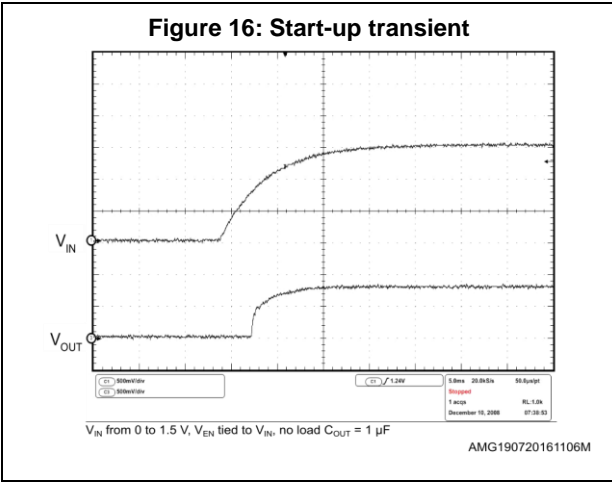
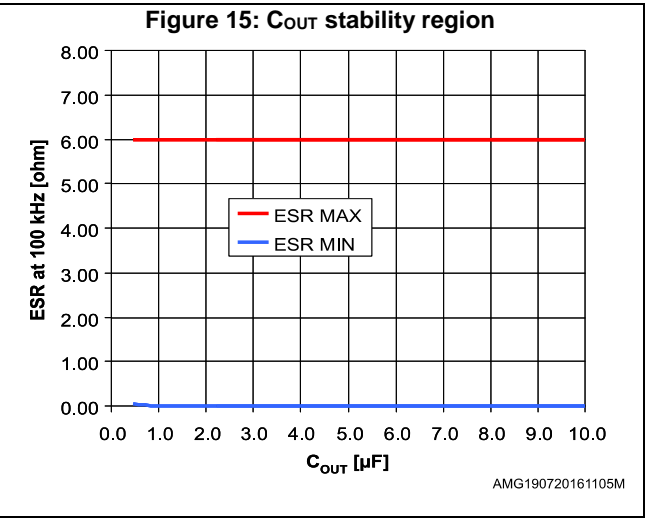
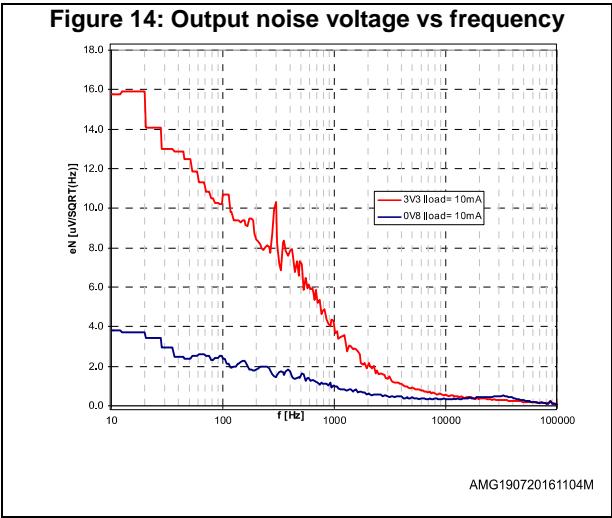

7 Package information

In order to meet environmental requirements, ST offers these devices in different grades of ECOPACK® packages, depending on their level of environmental compliance. ECOPACK® specifications, grade definitions and product status are available at: www.st.com. ECOPACK® is an ST trademark.

7.1 SOT23-5L package information

Figure 18: SOT23-5L package outline

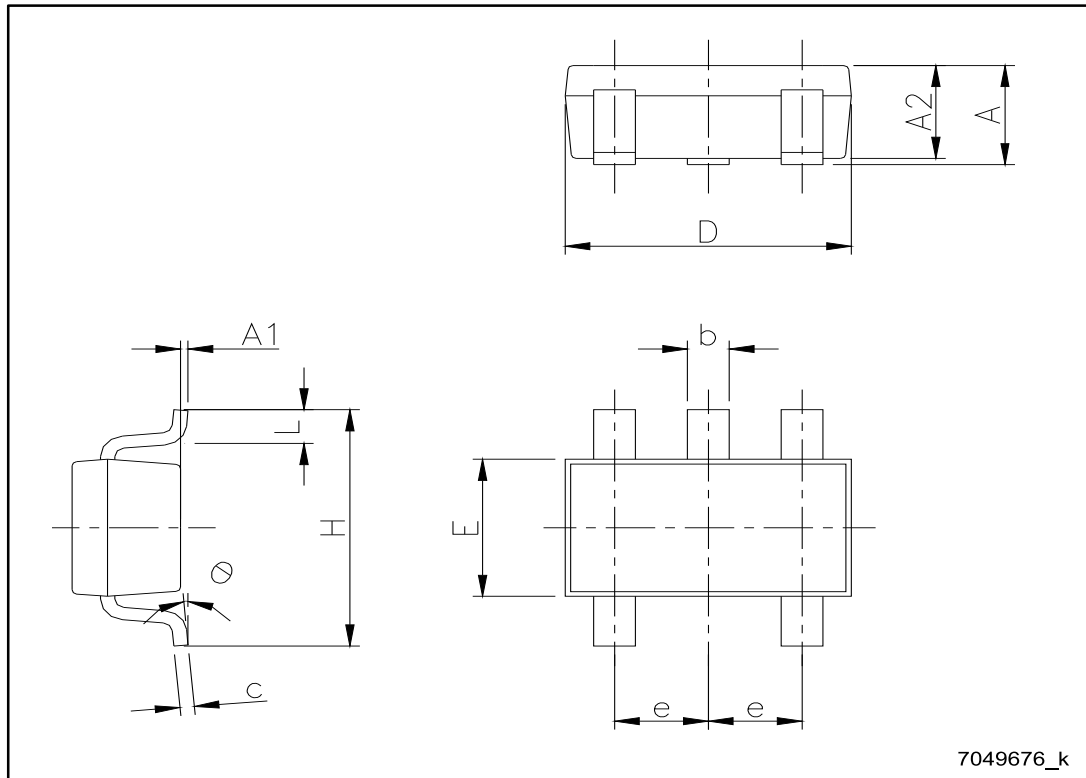
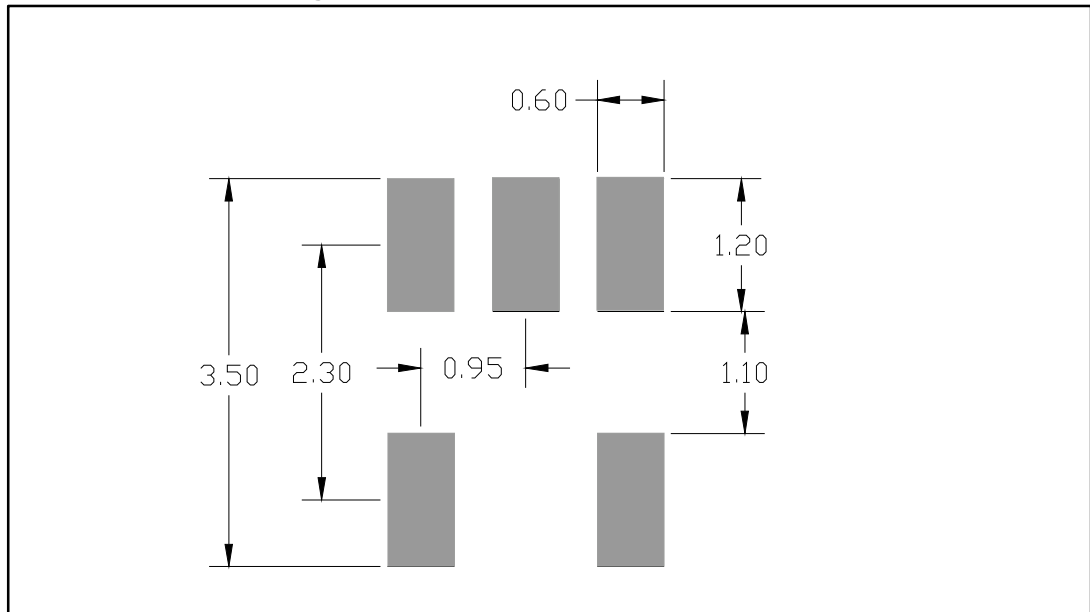

Table 5: SOT23-5L package mechanical data

Dim.	mm		
	Min.	Typ.	Max.
A	0.90		1.45
A1	0		0.15
A2	0.90		1.30
b	0.30		0.50
c	0.09		0.20
D		2.95	
E		1.60	
e		0.95	
H		2.80	
L	0.30		0.60
θ	0°		8°

Figure 19: SOT23-5L recommended footprint



Dimensions are in mm

7.2 SOT23-5L packing information

Figure 20: SOT23-5L tape and reel outline

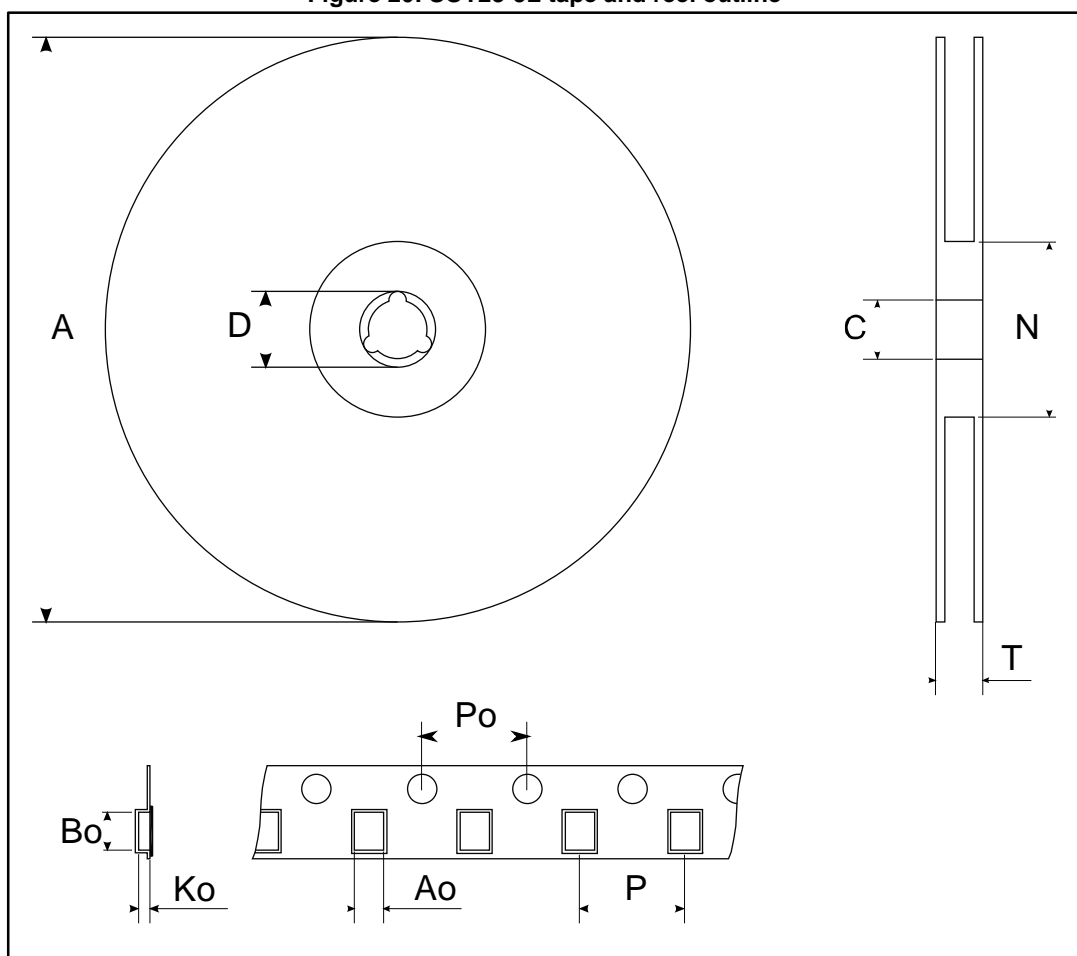

Table 6: SOT23-5L tape and reel mechanical data

Dim.	mm		
	Min.	Typ.	Max.
A			180
C	12.8	13.0	13.2
D	20.2		
N	60		
T			14.4
Ao	3.13	3.23	3.33
Bo	3.07	3.17	3.27
Ko	1.27	1.37	1.47
Po	3.9	4.0	4.1
P	3.9	4.0	4.1

8 Ordering information

Table 7: Order code

Order code	Output voltage	Package	Marking
STLQ015M12R	1.2 V	SOT23-5L	1512
STLQ015M15R	1.5 V		1515
STLQ015M18R	1.8 V		1518
STLQ015M21R	2.1 V		1521
STLQ015M25R	2.5 V		1525
STLQ015M28R	2.8 V		1528
STLQ015M30R	3.0 V		1530
STLQ015M31R	3.1 V		1531
STLQ015M33R	3.3 V		1533

9 Revision history

Table 8: Document revision history

Date	Revision	Changes
23-Mar-2010	1	Initial release.
20-Jan-2011	2	Modified: Table 5 on page 13 and Figure 18. Added: Figure 19.
11-Sep-2012	3	Added: new order codes STLQ015XG12R, STLQ015XG15R and STLQ015XG18R to the device summary table.
17-Feb-2014	4	Changed the part number STLQ015xx to STLQ015. Changed the title in cover page. Updated Description and Table : in cover page. Changed typ. value of I _Q parameter in Table 4: Electrical characteristics. Minor text changes.
03-Jul-2015	5	Added package SOT23-5L. Updated <i>Table 1.: Pin description</i> , <i>Table 3.: Thermal data</i> and <i>Figure 2.: Pin configuration (top view)</i> Updated 8: <i>Order code</i> . Updated <i>Section 7: Package information</i> . Minor text changes.
02-Sep-2016	6	Updated Section 8: "Ordering information" . Minor text changes.

IMPORTANT NOTICE – PLEASE READ CAREFULLY

STMicroelectronics NV and its subsidiaries ("ST") reserve the right to make changes, corrections, enhancements, modifications, and improvements to ST products and/or to this document at any time without notice. Purchasers should obtain the latest relevant information on ST products before placing orders. ST products are sold pursuant to ST's terms and conditions of sale in place at the time of order acknowledgement.

Purchasers are solely responsible for the choice, selection, and use of ST products and ST assumes no liability for application assistance or the design of Purchasers' products.

No license, express or implied, to any intellectual property right is granted by ST herein.

Resale of ST products with provisions different from the information set forth herein shall void any warranty granted by ST for such product.

ST and the ST logo are trademarks of ST. All other product or service names are the property of their respective owners.

Information in this document supersedes and replaces information previously supplied in any prior versions of this document.

© 2016 STMicroelectronics – All rights reserved