

## 300 mA low quiescent current soft-start, low noise voltage regulator

Datasheet - production data

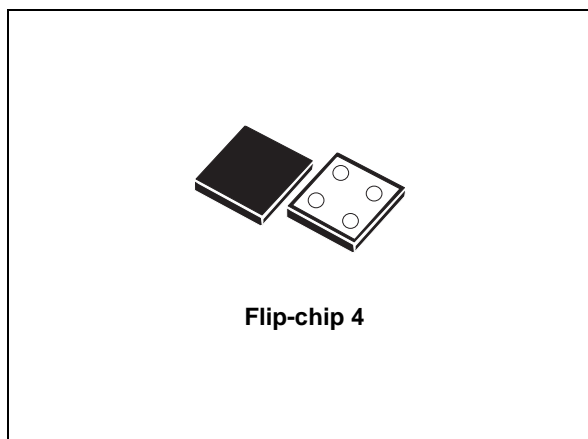

### Features

- Input voltage from 1.5 to 5.5 V
- Ultra low dropout voltage (200 mV typ. at 300 mA load)
- Very low quiescent current (20  $\mu$ A typ. at no load, 40  $\mu$ A typ. at 300 mA load, 1  $\mu$ A max. in off mode)
- Very low noise (30  $\mu$ V<sub>RMS</sub> from 1 kHz to 100 kHz at V<sub>OUT</sub> = 1.8 V)
- Output voltage tolerance:  $\pm$  2.0 % @ 25 °C
- 300 mA guaranteed output current
- Wide range of output voltages available on request: 0.8 V to 4.5 V with 100 mV step
- Logic-controlled electronic shutdown
- Compatible with ceramic capacitor C<sub>OUT</sub> = 1  $\mu$ F
- Internal current and thermal limit
- Flip-chip 4 bumps 0.8 x 0.8 mm pitch 0.4 mm
- Internal soft-start (typ. 100  $\mu$ s)
- Temperature range: - 40 °C to 125 °C

### Applications

- Mobile phones
- Personal digital assistants (PDAs)
- Cordless phones and similar battery-powered systems
- Digital still cameras.

### Description

The LD39030SJ is a low noise voltage regulator that provides 300 mA maximum current from an input voltage in the 1.5 V to 5.5 V range, with a typical dropout voltage of 200 mV. It is stabilized with a ceramic capacitor on the output. The ultra low drop voltage, low quiescent current, and low noise features make it suitable for low power battery-powered applications. Power supply rejection is typically 62 dB at low frequencies and starts to roll off at 10 kHz. An enable logic control function puts the LD39030SJ in shutdown mode allowing a total current consumption lower than 1  $\mu$ A. The device also includes a short-circuit constant current limiting and thermal protection.

**Table 1. Device summary**

Order codes	Output voltages
LD39030SJ10R	1 V
LD39030SJ12R	1.2 V
LD39030SJ126R	1.26 V
LD39030SJ28R	2.8 V
LD39030SJ285R	2.85 V
LD39030SJ33R	3.3 V

# Contents

1	Block diagram .....	3
2	Pin configuration .....	4
3	Typical application .....	5
4	Maximum ratings .....	6
5	Electrical characteristics .....	7
6	Soft-start function .....	9
7	Typical performance characteristics .....	10
8	Package mechanical data .....	13
9	Packaging mechanical data .....	15
10	Revision history .....	17



# 1 Block diagram

Figure 1. Block diagram

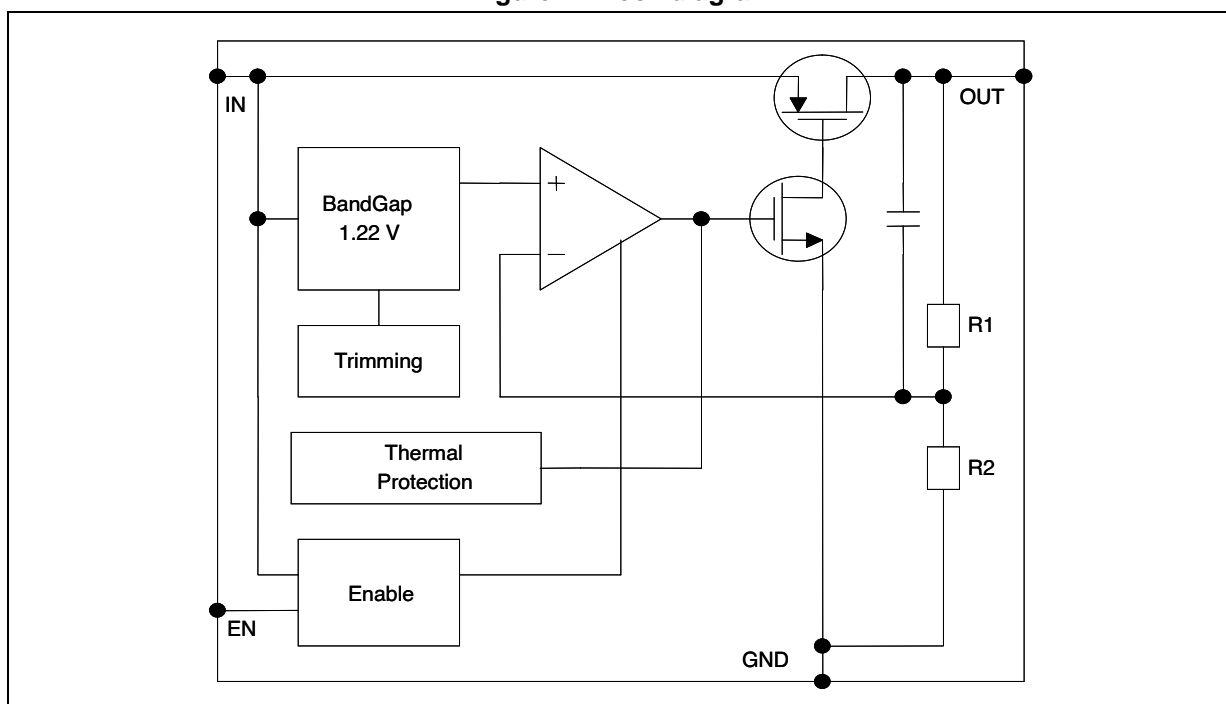

## 2 Pin configuration

Figure 2. Pin connection (top view)

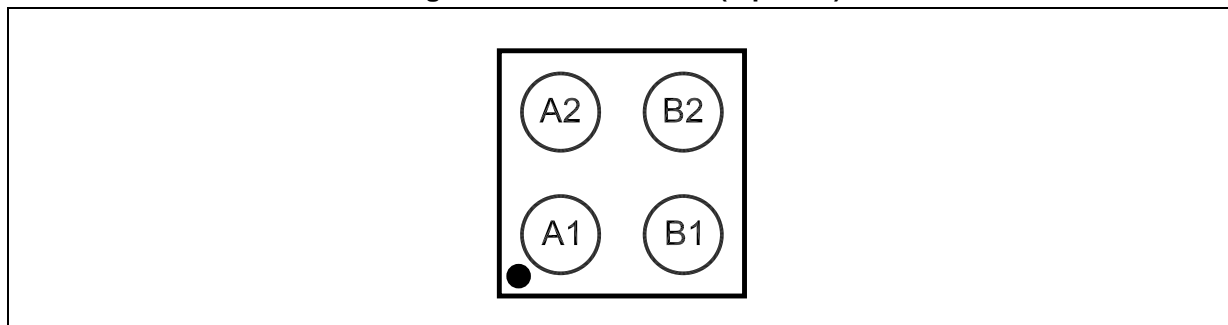
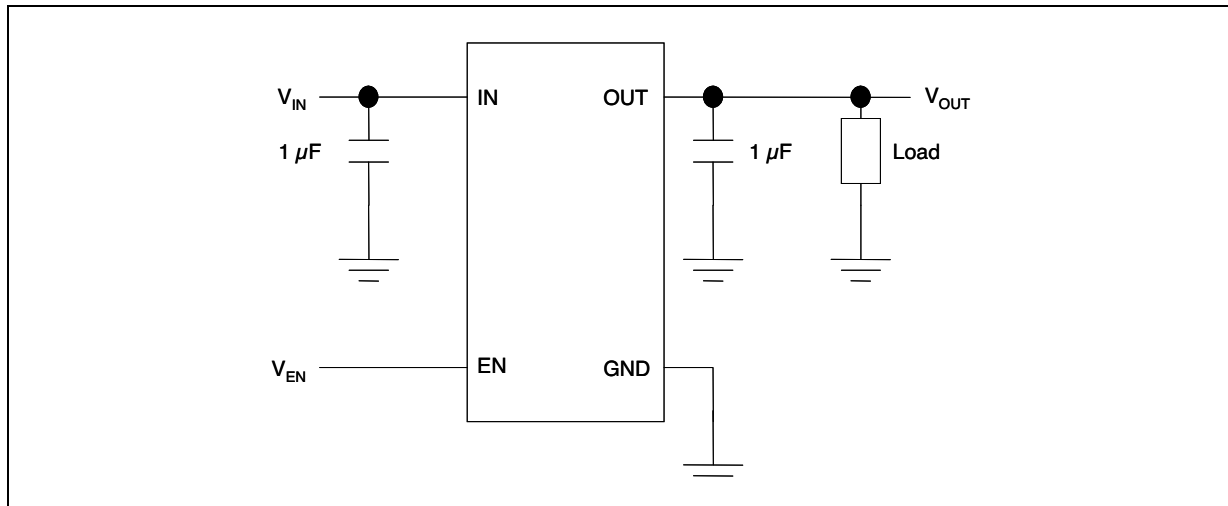

Table 2. Pin description

Pin n°	Symbol	Function
A2	EN	Enable pin logic input: low = shutdown, high = active
A1	GND	Common ground
B2	IN	Input voltage of the LDO
B1	OUT	Output voltage

### 3 Typical application

Figure 3. Typical application circuit



## 4 Maximum ratings

**Table 3. Absolute maximum ratings**

Symbol	Parameter	Value	Unit
$V_{IN}$	DC input voltage	- 0.3 to 6	V
$V_{OUT}$	DC output voltage	- 0.3 to $V_{IN} + 0.3$	V
$V_{EN}$	Enable input voltage	- 0.3 to $V_{IN} + 0.3$	V
$I_{OUT}$	Output current	Internally limited	mA
$P_D$	Power dissipation	Internally limited	mW
$T_{STG}$	Storage temperature range	- 65 to 150	°C
$T_{OP}$	Operating junction temperature range	- 40 to 125	°C

*Note: Absolute maximum ratings are those values beyond which damage to the device may occur. Functional operation under these conditions is not implied. All values are referred to GND.*

**Table 4. Thermal data**

Symbol	Parameter	Value	Unit
$R_{thJA}$	Thermal resistance junction-ambient	180	°C/W

## 5 Electrical characteristics

$T_J = 25\text{ °C}$ ,  $V_{IN} = V_{OUT(NOM)} + 1\text{ V}$ ,  $C_{IN} = C_{OUT} = 1\text{ }\mu\text{F}$ ,  $I_{OUT} = 1\text{ mA}$ ,  $V_{EN} = V_{IN}$ , unless otherwise specified.

Table 5. Electrical characteristics <sup>(1)</sup>

Symbol	Parameter	Test conditions	Min.	Typ.	Max.	Unit
$V_{IN}$	Operating input voltage		1.5		5.5	V
$V_{UVLO}$	Turn-on threshold			1.45	1.48	V
	Turn-off threshold		1.30	1.35		mV
$V_{OUT}$	$V_{OUT}$ accuracy	$V_{OUT} > 1.5\text{ V}$ , $I_{OUT} = 1\text{ mA}$ , $T_J = 25\text{ °C}$	-2.0		2.0	%
		$V_{OUT} > 1.5\text{ V}$ , $I_{OUT} = 1\text{ mA}$ , $-40\text{ °C} < T_J < 125\text{ °C}$	-3.0		3.0	%
		$V_{OUT} \leq 1.5\text{ V}$ , $I_{OUT} = 1\text{ mA}$		$\pm 10$		mV
		$V_{OUT} \leq 1.5\text{ V}$ , $I_{OUT} = 1\text{ mA}$ , $-40\text{ °C} < T_J < 125\text{ °C}$		$\pm 30$		mV
$\Delta V_{OUT}$	Static line regulation	$V_{OUT} + 1\text{ V} \leq V_{IN} \leq 5.5\text{ V}$ , $I_{OUT} = 1\text{ mA}$		0.01		%/V
$\Delta V_{OUT}$	Transient line regulation <sup>(2)</sup>	$\Delta V_{IN} = +500\text{ mV}$ , $I_{OUT} = 1\text{ mA}$ , $T_R = T_F = 5\text{ }\mu\text{s}$		10		mVpp
$\Delta V_{OUT}$	Static load regulation	$I_{OUT} = 1\text{ mA}$ to $300\text{ mA}$		0.002		%/mA
$\Delta V_{OUT}$	Transient load regulation <sup>(2)</sup>	$I_{OUT} = 1\text{ mA}$ to $300\text{ mA}$ , $T_R = T_F = 5\text{ }\mu\text{s}$		40		mVpp
$V_{DROP}$	Dropout voltage <sup>(3)</sup>	$I_{OUT} = 300\text{ mA}$ , $V_{OUT} > 1.5\text{ V}$ $-40\text{ °C} < T_J < 125\text{ °C}$		200	300	mV
$e_N$	Output noise voltage	10 Hz to 100 kHz, $I_{OUT} = 10\text{ mA}$		30		$\mu\text{V}_{RMS}/\text{V}$
SVR	Supply voltage rejection $V_{OUT} = 1.2\text{ V}$	$V_{IN} = V_{OUTNOM} + 1\text{ V} \pm V_{RIPPLE}$ $V_{RIPPLE} = 0.1\text{ V}$ Freq. = 1 kHz $I_{OUT} = 10\text{ mA}$		62		dB
		$V_{IN} = V_{OUTNOM} + 0.5\text{ V} \pm V_{RIPPLE}$ $V_{RIPPLE} = 0.1\text{ V}$ Freq. = 10 kHz $I_{OUT} = 10\text{ mA}$		62		
$I_Q$	Quiescent current	$I_{OUT} = 0\text{ mA}$		20		$\mu\text{A}$
		$I_{OUT} = 0\text{ mA}$ , $-40\text{ °C} < T_J < 125\text{ °C}$			50	
		$I_{OUT} = 0$ to $300\text{ mA}$		40		
		$I_{OUT} = 0$ to $300\text{ mA}$ , $-40\text{ °C} < T_J < 125\text{ °C}$			85	
		$V_{IN}$ input current in OFF MODE: $V_{EN} = \text{GND}$		0.001	1	
$I_{SC}$	Short-circuit current	$R_L = 0$	400			mA

Table 5. Electrical characteristics (continued) (1)

Symbol	Parameter	Test conditions	Min.	Typ.	Max.	Unit
$V_{EN}$	Enable input logic low	$V_{IN}=1.5\text{ V to }5.5\text{ V, }-40\text{ }^{\circ}\text{C}<T_J<125\text{ }^{\circ}\text{C}$			0.4	V
	Enable input logic high	$V_{IN}=1.5\text{ V to }5.5\text{ V, }-40\text{ }^{\circ}\text{C}<T_J<125\text{ }^{\circ}\text{C}$	0.9			
$I_{EN}$	Enable pin input current	$V_{SHDN}=V_{IN}$		0.1	100	nA
$T_{ON}$	Turn-on time (4)			100		$\mu\text{s}$
$T_{SHDN}$	Thermal shutdown			160		$^{\circ}\text{C}$
	Hysteresis			20		
$C_{OUT}$	Output capacitor	Capacitance (see <a href="#">Section 7: Typical performance characteristics</a> )	1		22	$\mu\text{F}$

1. For  $V_{OUT(NOM)} < 1.2\text{ V}$ ,  $V_{IN} = 1.5\text{ V}$ .
2. All transient values are guaranteed by design, not production tested.
3. Dropout voltage is the input-to-output voltage difference at which the output voltage is 100 mV below its nominal value. This specification does not apply for output voltages below 1.5 V.
4. Turn-on time is time measured between the enable input just exceeding  $V_{EN}$  high value and the output voltage just reaching 95 % of its nominal value.



## 6 Soft-start function

The LD39030S has an internal soft-start circuit. By increasing the startup time up to  $100\ \mu\text{s}$ , without the need of any external soft-start capacitor, this feature is able to reduce the regulator inrush current to 1/3 of the original value.

Figure 4. Soft-start function

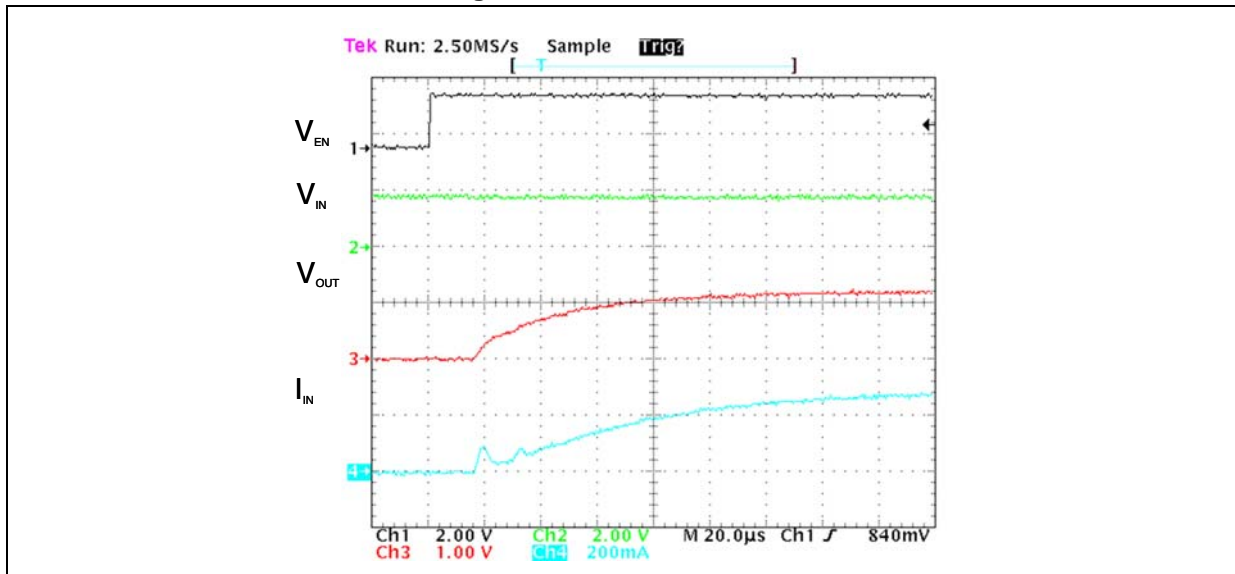

$V_{IN} = 1.8\ \text{V}$ ,  $V_{EN} = 1.8\ \text{V}$ ,  $C_{IN} = 1\ \mu\text{F}$ ,  $C_{OUT} = 1\ \mu\text{F}$ .

# 7 Typical performance characteristics

$C_{IN} = C_{OUT} = 1 \mu F, V_{EN}$  to  $V_{IN}$ .

Figure 5. Output voltage vs. temperature

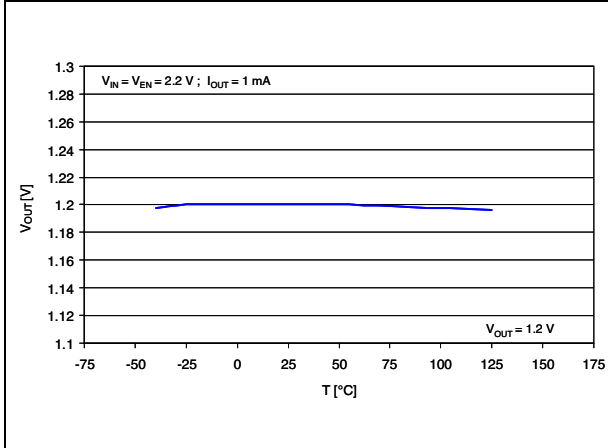

Figure 6. Output voltage vs. input voltage

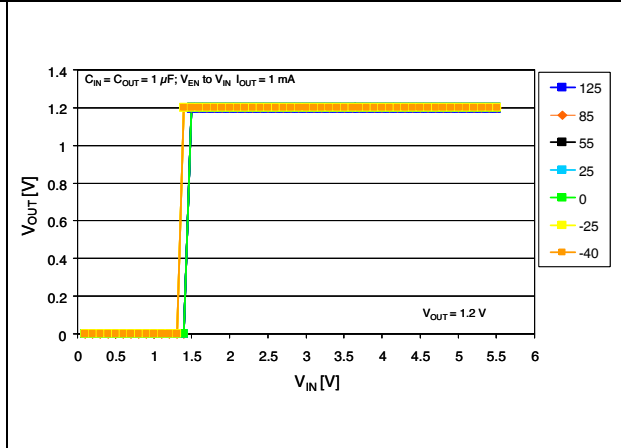

Figure 7. Line regulation vs. temperature

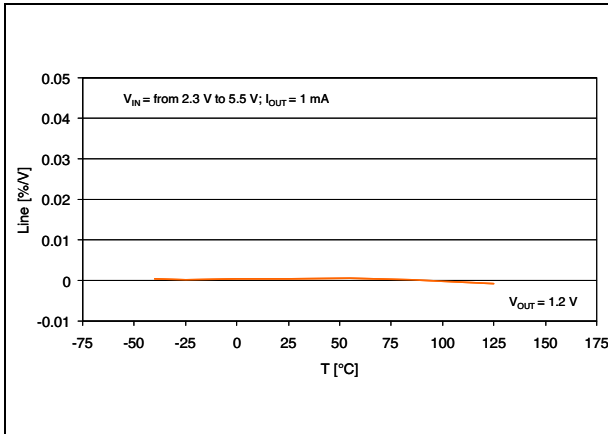

Figure 8. Load regulation vs. temperature

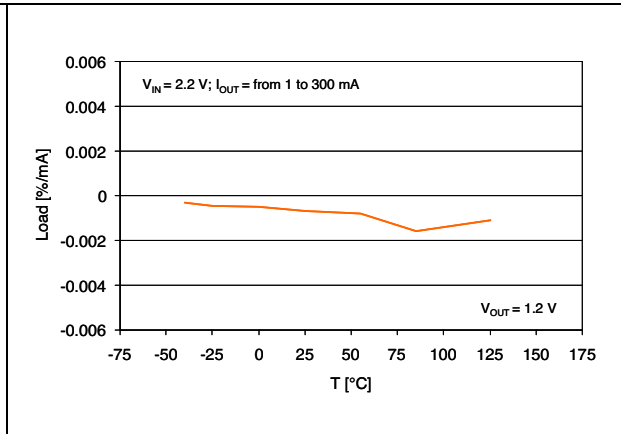

Figure 9. Short-circuit current vs. drop voltage

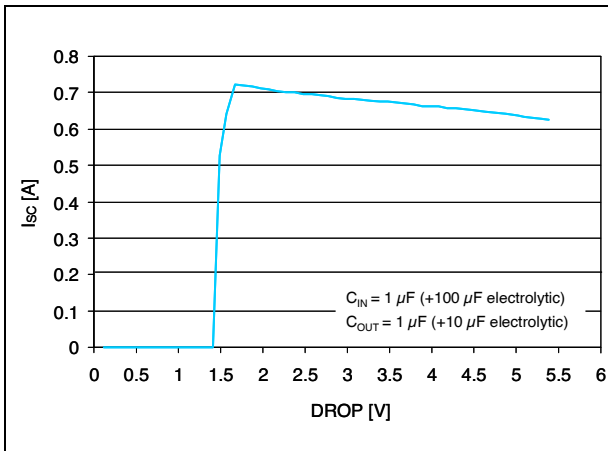

Figure 10. Quiescent current vs. input voltage

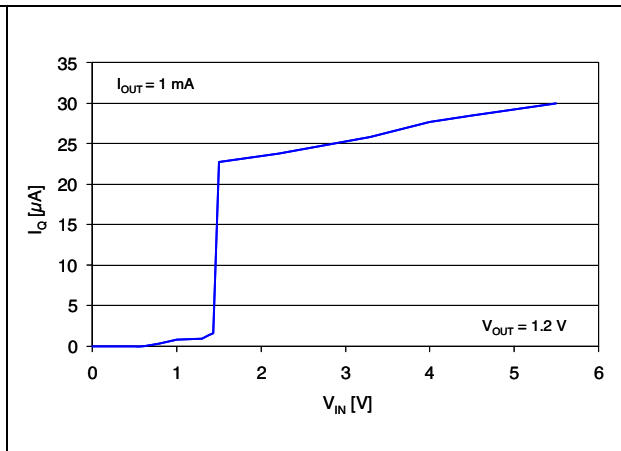

Figure 11. Enable threshold vs. temperature

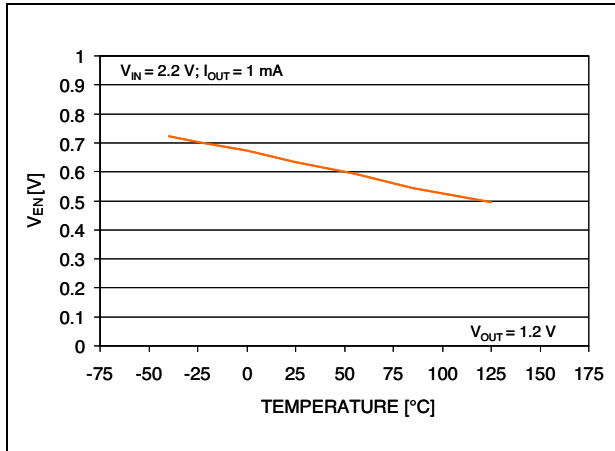

Figure 12. Quiescent current vs. temperature

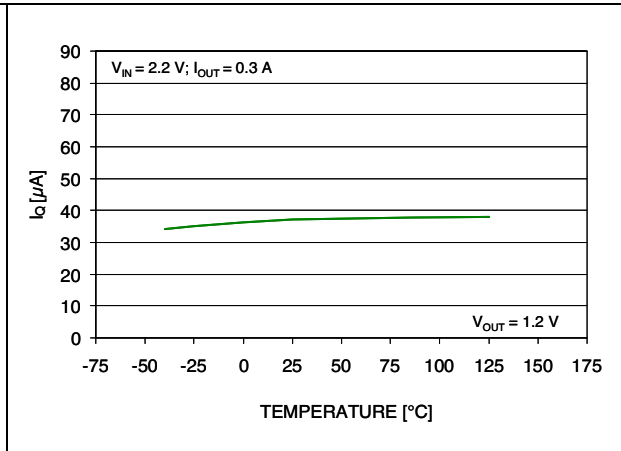

Figure 13. Supply voltage rejection vs. temperature (Freq. = 1 kHz)

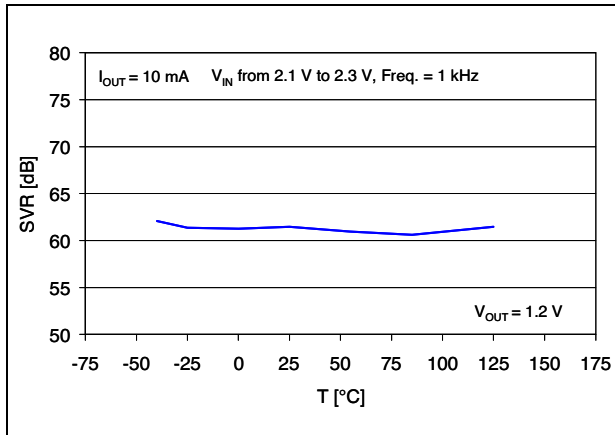

Figure 14. Supply voltage rejection vs. frequency (V<sub>IN</sub> = 1.6 V to 1.8 V)

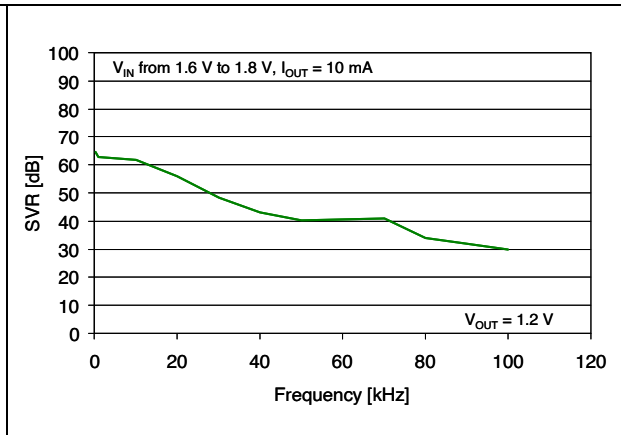

Figure 15. Supply voltage rejection vs. temperature (Freq. = 10 kHz)

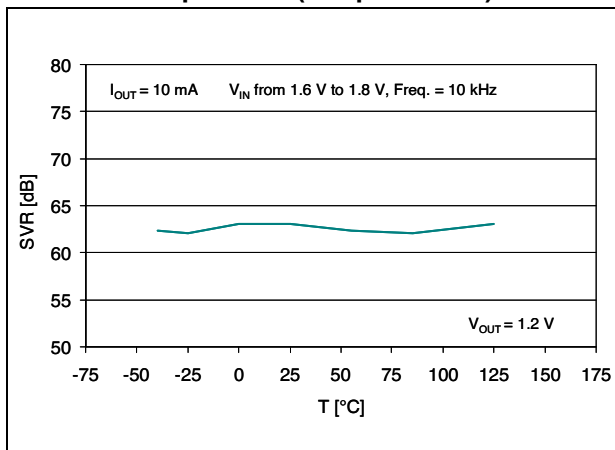

Figure 16. Supply voltage rejection vs. frequency (V<sub>IN</sub> = 2.1 V to 2.3 V)

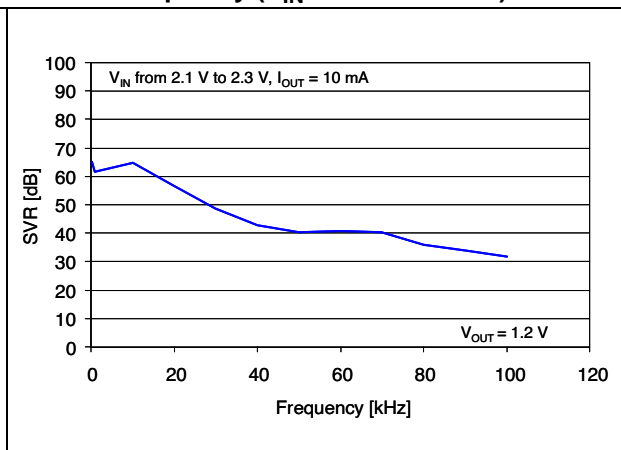

Figure 17. Line transient

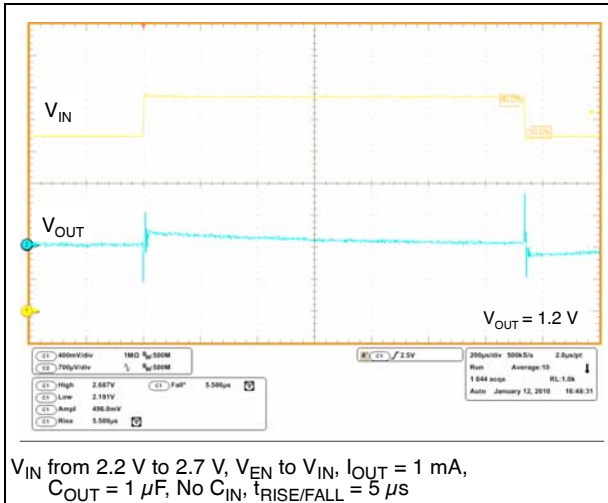

Figure 18. Load transient

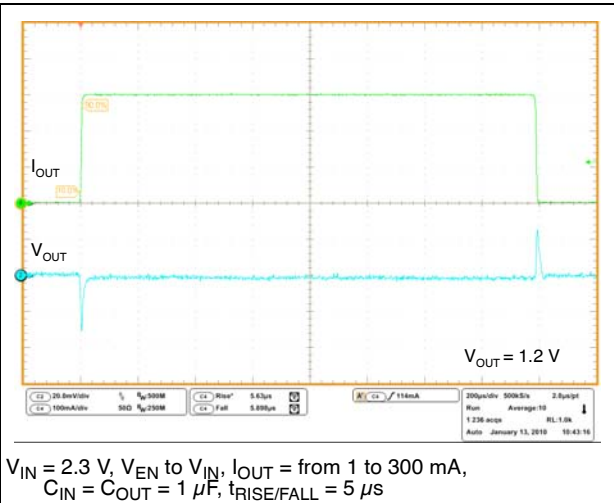

Figure 19. Enable transient

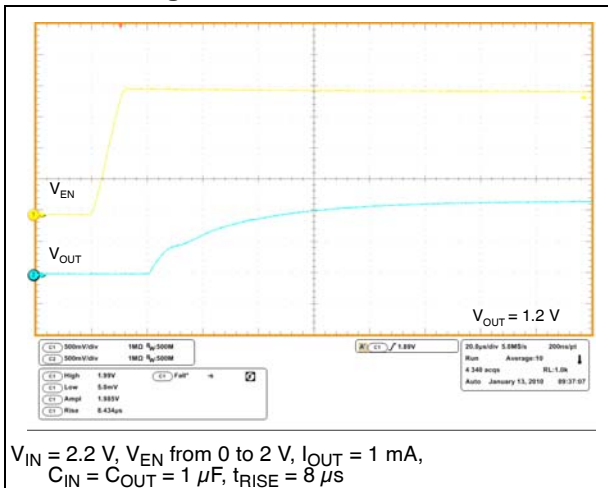

Figure 20. Startup transient

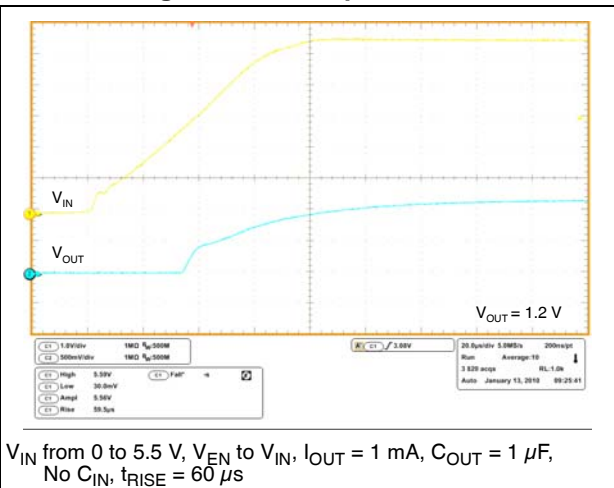
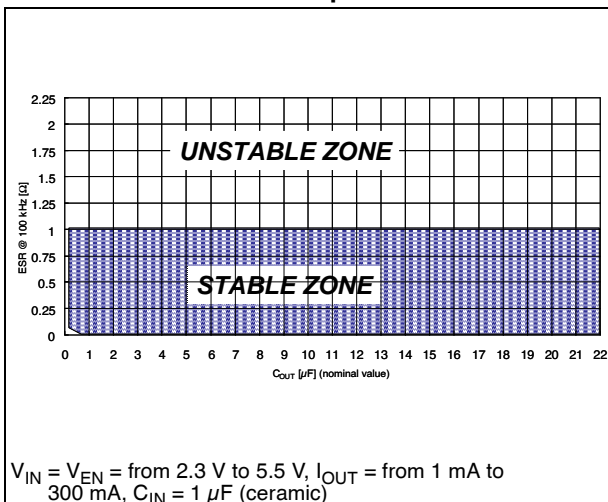

Figure 21. ESR required for stability with ceramic capacitors



## 8 Package mechanical data

In order to meet environmental requirements, ST offers these devices in different grades of ECOPACK® packages, depending on their level of environmental compliance. ECOPACK specifications, grade definitions, and product status are available at: [www.st.com](http://www.st.com). ECOPACK is an ST registered trademark.

Figure 22. Flip-chip 4 package drawing (dimensions are in mm.)

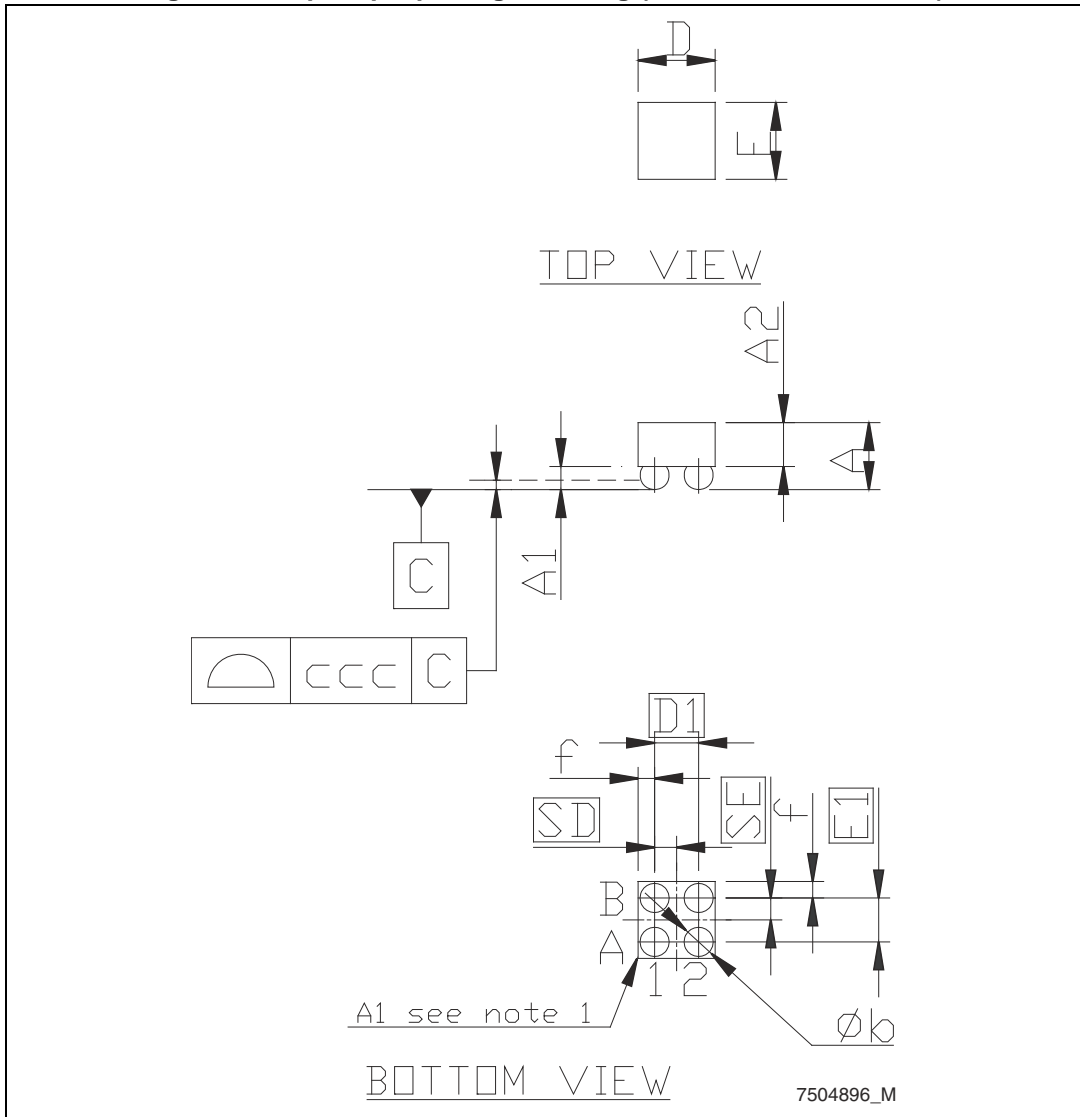
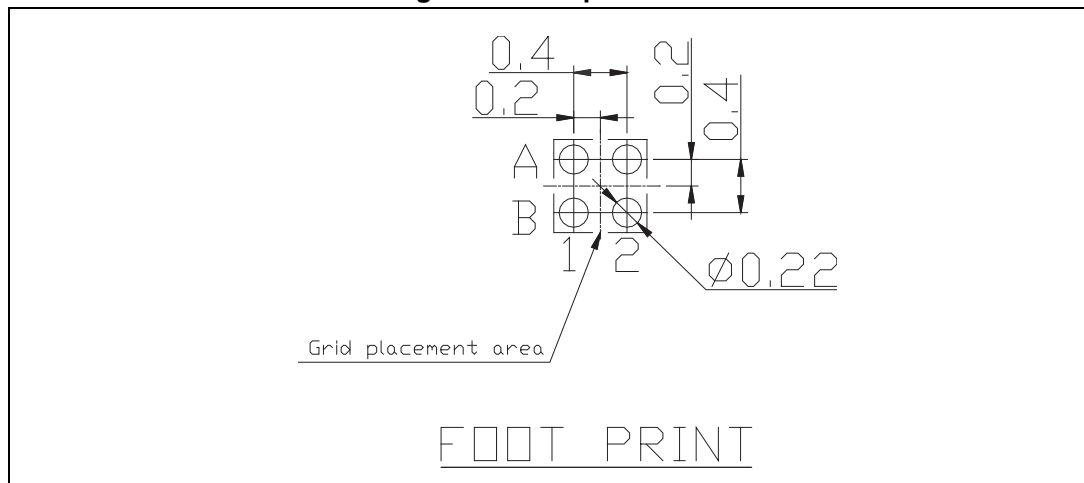

Table 6. Flip-chip 4 package mechanical data

Dim.	mm.		
	Min.	Typ.	Max.
A	0.52	0.56	0.60
A1	0.17	0.20	0.23
A2	0.35	0.36	0.37
b	0.23	0.25	0.29
D	0.758	0.788	0.818
D1		0.4	
E	0.758	0.788	0.818
E1		0.4	
SD	0.18	0.2	0.22
SE	0.18	0.2	0.22
f		0.199	
ccc		0.075	

Figure 23. Footprint data



## 9 Packaging mechanical data

Figure 24. Flip-chip 4 tape and reel drawing

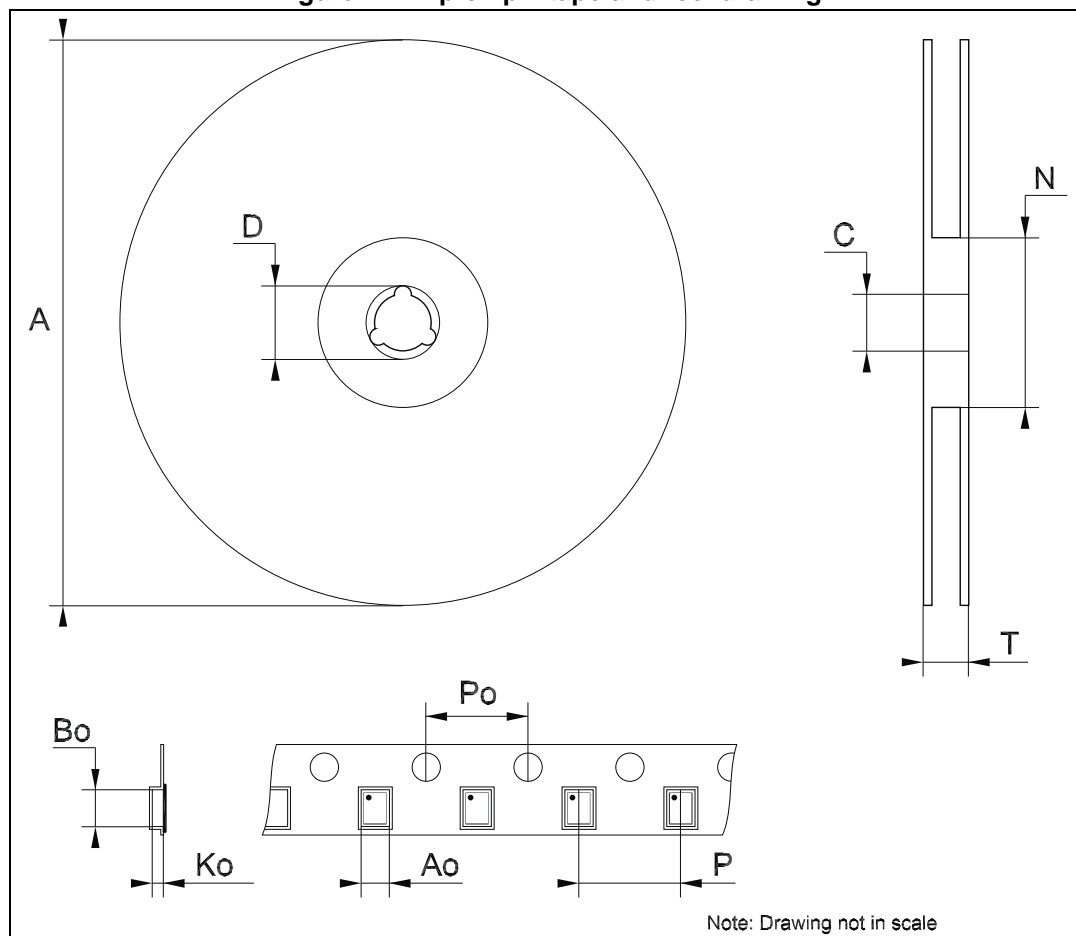

Table 7. Flip-chip 4 tape and reel mechanical data

Dim.	mm		
	Min.	Typ.	Max.
A			178
C	12.8		13.2
D	20.2		
N	59	60	61
T			8.4
Ao	0.82	0.87	0.92
Bo	0.82	0.87	0.92
Ko	0.64	0.69	0.74
Po	3.9	4.0	4.1
P	3.9	4.0	4.1



## 10 Revision history

**Table 8. Document revision history**

Date	Revision	Changes
14-Oct-2010	1	First release.
10-Jul-2012	2	Added new order code LD39030SJ33R <a href="#">Table 1 on page 1</a> . Updated Flip-chip 4 mechanical data <a href="#">Table 6 on page 14</a> and <a href="#">Figure 22 on page 13</a> .
25-Oct-2012	3	Added new order code LD39030SJ126R <a href="#">Table 1 on page 1</a> . Document status promoted from preliminary data to production data.
08-Feb-2013	4	Added <a href="#">Table 7: Options available on request on page 15</a> .
06-Feb-2014	5	Part number LD39030SJxx changed to LD39030SJ. Updated <a href="#">Table 1: Device summary</a> , <a href="#">Section 8: Package mechanical data</a> and <a href="#">Section 9: Packaging mechanical data</a> . Minor text changes.

**Please Read Carefully:**

Information in this document is provided solely in connection with ST products. STMicroelectronics NV and its subsidiaries ("ST") reserve the right to make changes, corrections, modifications or improvements, to this document, and the products and services described herein at any time, without notice.

All ST products are sold pursuant to ST's terms and conditions of sale.

Purchasers are solely responsible for the choice, selection and use of the ST products and services described herein, and ST assumes no liability whatsoever relating to the choice, selection or use of the ST products and services described herein.

No license, express or implied, by estoppel or otherwise, to any intellectual property rights is granted under this document. If any part of this document refers to any third party products or services it shall not be deemed a license grant by ST for the use of such third party products or services, or any intellectual property contained therein or considered as a warranty covering the use in any manner whatsoever of such third party products or services or any intellectual property contained therein.

**UNLESS OTHERWISE SET FORTH IN ST'S TERMS AND CONDITIONS OF SALE ST DISCLAIMS ANY EXPRESS OR IMPLIED WARRANTY WITH RESPECT TO THE USE AND/OR SALE OF ST PRODUCTS INCLUDING WITHOUT LIMITATION IMPLIED WARRANTIES OF MERCHANTABILITY, FITNESS FOR A PARTICULAR PURPOSE (AND THEIR EQUIVALENTS UNDER THE LAWS OF ANY JURISDICTION), OR INFRINGEMENT OF ANY PATENT, COPYRIGHT OR OTHER INTELLECTUAL PROPERTY RIGHT.**

**ST PRODUCTS ARE NOT DESIGNED OR AUTHORIZED FOR USE IN: (A) SAFETY CRITICAL APPLICATIONS SUCH AS LIFE SUPPORTING, ACTIVE IMPLANTED DEVICES OR SYSTEMS WITH PRODUCT FUNCTIONAL SAFETY REQUIREMENTS; (B) AERONAUTIC APPLICATIONS; (C) AUTOMOTIVE APPLICATIONS OR ENVIRONMENTS, AND/OR (D) AEROSPACE APPLICATIONS OR ENVIRONMENTS. WHERE ST PRODUCTS ARE NOT DESIGNED FOR SUCH USE, THE PURCHASER SHALL USE PRODUCTS AT PURCHASER'S SOLE RISK, EVEN IF ST HAS BEEN INFORMED IN WRITING OF SUCH USAGE, UNLESS A PRODUCT IS EXPRESSLY DESIGNATED BY ST AS BEING INTENDED FOR "AUTOMOTIVE, AUTOMOTIVE SAFETY OR MEDICAL" INDUSTRY DOMAINS ACCORDING TO ST PRODUCT DESIGN SPECIFICATIONS. PRODUCTS FORMALLY ESCC, QML OR JAN QUALIFIED ARE DEEMED SUITABLE FOR USE IN AEROSPACE BY THE CORRESPONDING GOVERNMENTAL AGENCY.**

Resale of ST products with provisions different from the statements and/or technical features set forth in this document shall immediately void any warranty granted by ST for the ST product or service described herein and shall not create or extend in any manner whatsoever, any liability of ST.

ST and the ST logo are trademarks or registered trademarks of ST in various countries.

Information in this document supersedes and replaces all information previously supplied.

The ST logo is a registered trademark of STMicroelectronics. All other names are the property of their respective owners.

© 2014 STMicroelectronics - All rights reserved

STMicroelectronics group of companies

Australia - Belgium - Brazil - Canada - China - Czech Republic - Finland - France - Germany - Hong Kong - India - Israel - Italy - Japan - Malaysia - Malta - Morocco - Philippines - Singapore - Spain - Sweden - Switzerland - United Kingdom - United States of America

[www.st.com](http://www.st.com)