

## Very low drop and low noise voltage regulator with inhibit function

Datasheet - production data



to 30  $\mu$ Vrms. Typical application are in cellular phone, palmtop laptop computer, personal digital assistant (PDA), personal stereo, camcorder and camera.

**Table 1. Device summary**

Order codes	Output voltages
LD2985BM18R	1.8 V
LD2985BM25R	2.5 V
LD2985BM28R	2.8 V
LD2985BM30R	3.0 V
LD2985BM31R	3.1 V
LD2985BM33R	3.3 V
LD2985BM50R	5.0 V

### Features

- Very low dropout voltage (280 mV at 150 mA and 7 mV at 1 mA load)
- Very low quiescent current (2 mA typ. at 150 mA load and 80  $\mu$ A at no load)
- Output current up to 150 mA
- Logic controlled electronic shutdown
- Output voltage of 1.8, 2.5, 2.8, 3, 3.1, 3.3, 5 V
- Internal current and thermal limit
- Low output noise voltage 30 mVrms
- Small package SOT23-5L
- Temperature range: - 40°C to 125 °C

### Description

The LD2985 is a 150 mA fixed output voltage regulator. The ultra low drop voltage and the low quiescent current make them particularly suitable for low noise, low power applications, and in battery powered systems. In sleep mode quiescent current is less than 1  $\mu$ A when INHIBIT pin is pulled low. Shutdown logic control function is available on pin 3 (TTL compatible). This means that when the device is used as local regulator, it is possible to put a part of the board in standby, decreasing the total power consumption. An external capacitor,  $C_{BYP} = 10$  nF, connected between bypass pin and GND reduces the noise

# Contents

<b>1</b>	<b>Diagram</b> .....	<b>3</b>
<b>2</b>	<b>Pin configuration</b> .....	<b>4</b>
<b>3</b>	<b>Maximum ratings</b> .....	<b>5</b>
<b>4</b>	<b>Electrical characteristics</b> .....	<b>6</b>
<b>5</b>	<b>Typical characteristics</b> .....	<b>9</b>
<b>6</b>	<b>Application notes</b> .....	<b>12</b>
6.1	External capacitors .....	12
6.2	Input capacitor .....	12
6.3	Output capacitor .....	12
6.4	Important .....	12
6.5	Inhibit input operation .....	12
6.6	Reverse current .....	13
<b>7</b>	<b>Package mechanical data</b> .....	<b>14</b>
<b>8</b>	<b>Packaging mechanical data</b> .....	<b>16</b>
<b>9</b>	<b>Revision history</b> .....	<b>17</b>

# 1 Diagram

Figure 1. Schematic diagram

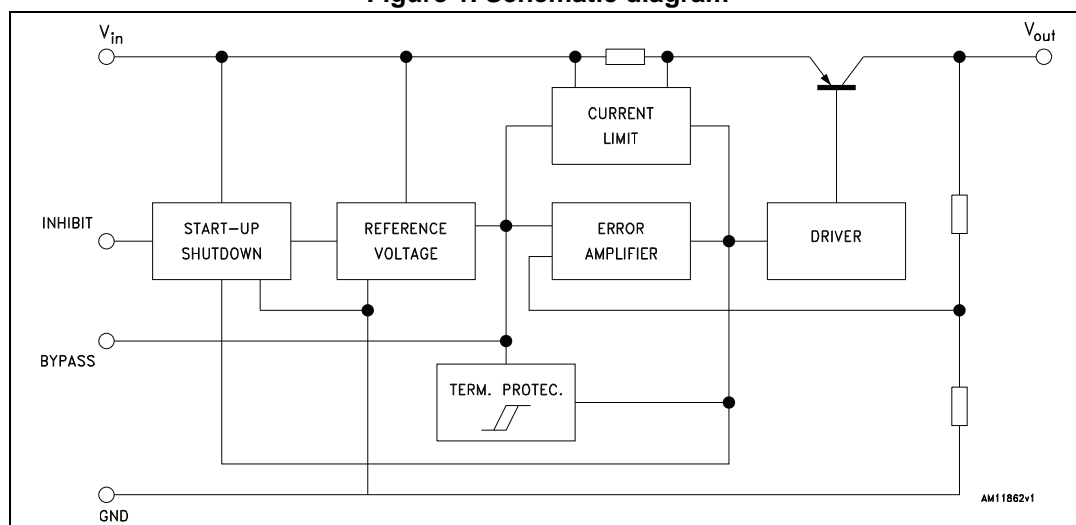

## 2 Pin configuration

Figure 2. Pin connections (top view)

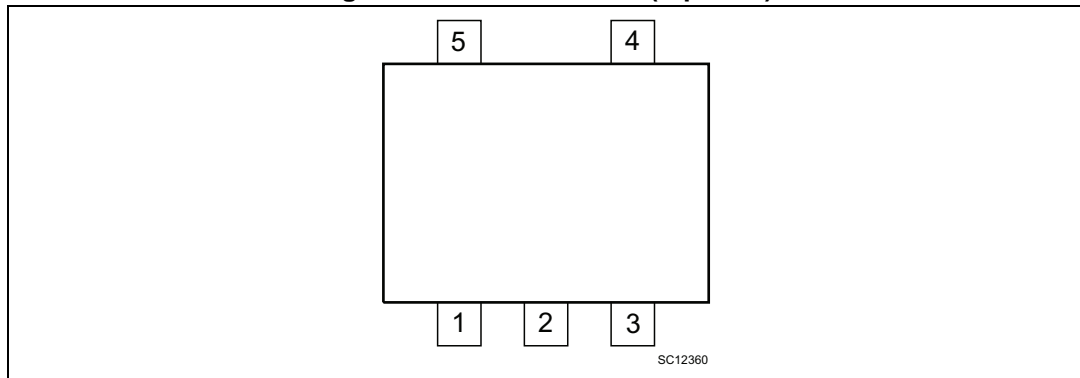

Table 2. Pin description

Pin n°	Symbol	Name and function
1	IN	Input port
2	GND	Ground pin
3	INHIBIT	Control switch ON/OFF. Inhibit is not internally pulled-up; it cannot be left floating. Disable the device when connected to GND or to a positive voltage less than 0.18 V
4	Bypass	Bypass pin: capacitor to be connected to GND in order to improve the thermal noise performances
5	OUT	Output port

Table 3. Thermal data

Symbol	Parameter	Value	Unit
$R_{thJC}$	Thermal resistance junction-case	81	°C/W
$R_{thJA}$	Thermal resistance junction-ambient	255	°C/W

### 3 Maximum ratings

**Table 4. Absolute maximum ratings**

Symbol	Parameter	Value	Unit
$V_I$	DC input voltage	16	V
$V_{INH}$	INHIBIT input voltage	16	V
$I_O$	Output current	Internally limited	
$P_D$	Power dissipation	Internally limited	
$T_{STG}$	Storage temperature range	-65 to 150	°C
$T_{OP}$	Operating junction temperature range	-40 to 125	°C

*Note:* Absolute maximum ratings are those values beyond which damage to the device may occur. Functional operation under these condition is not implied.

## 4 Electrical characteristics

$T_J = 25\text{ °C}$ ,  $V_I = V_O + 1\text{ V}$ ,  $I_O = 50\text{ mA}$ ,  $V_{INH} = 2\text{ V}$ ,  $C_I = C_O = 1\text{ }\mu\text{F}$ , unless otherwise specified.

**Table 5. Electrical characteristics**

Symbol	Parameter	Test conditions	Min.	Typ.	Max.	Unit
$V_{OP}$	Operating input voltage		2.5		16	V
$V_O$	Output voltage	$V_I = 2.5\text{ V}$	1.463	1.5	1.537	V
		$I_O = 1\text{ to }150\text{ mA}$	1.455		1.545	
		$I_O = 1\text{ to }150\text{ mA}$ , $T_J = -40\text{ to }125\text{ °C}$	1.440		1.560	
$V_O$	Output voltage	$V_I = 2.8\text{ V}$	1.755	1.8	1.845	V
		$I_O = 1\text{ to }150\text{ mA}$	1.746		1.854	
		$I_O = 1\text{ to }150\text{ mA}$ , $T_J = -40\text{ to }125\text{ °C}$	1.728		1.872	
$V_O$	Output voltage	$V_I = 3.5\text{ V}$	2.437	2.5	2.562	V
		$I_O = 1\text{ to }150\text{ mA}$	2.425		2.575	
		$I_O = 1\text{ to }150\text{ mA}$ , $T_J = -40\text{ to }125\text{ °C}$	2.4		2.6	
$V_O$	Output voltage	$V_I = 3.5\text{ V}$	2.633	2.7	2.767	V
		$I_O = 1\text{ to }150\text{ mA}$	2.619		2.781	
		$I_O = 1\text{ to }150\text{ mA}$ , $T_J = -40\text{ to }125\text{ °C}$	2.592		2.808	
$V_O$	Output voltage	$V_I = 3.8\text{ V}$	2.73	2.8	2.87	V
		$I_O = 1\text{ to }150\text{ mA}$	2.716		2.884	
		$I_O = 1\text{ to }150\text{ mA}$ , $T_J = -40\text{ to }125\text{ °C}$	2.688		2.912	
$V_O$	Output voltage	$V_I = 3.85\text{ V}$	2.779	2.85	2.921	V
		$I_O = 1\text{ to }150\text{ mA}$	2.764		2.935	
		$I_O = 1\text{ to }150\text{ mA}$ , $T_J = -40\text{ to }125\text{ °C}$	2.736		2.964	
$V_O$	Output voltage	$V_I = 4.0\text{ V}$	2.925	3.0	3.075	V
		$I_O = 1\text{ to }150\text{ mA}$	2.91		3.09	
		$I_O = 1\text{ to }150\text{ mA}$ , $T_J = -40\text{ to }125\text{ °C}$	2.88		3.12	
$V_O$	Output voltage	$V_I = 4.1\text{ V}$	3.023	3.1	3.177	V
		$I_O = 1\text{ to }150\text{ mA}$	3.007		3.193	
		$I_O = 1\text{ to }150\text{ mA}$ , $T_J = -40\text{ to }125\text{ °C}$	2.976		3.224	
$V_O$	Output voltage	$V_I = 4.2\text{ V}$	3.120	3.2	3.28	V
		$I_O = 1\text{ to }150\text{ mA}$	3.104		3.296	
		$I_O = 1\text{ to }150\text{ mA}$ , $T_J = -40\text{ to }125\text{ °C}$	3.072		3.328	
$V_O$	Output voltage	$V_I = 4.3\text{ V}$	3.218	3.3	3.382	V
		$I_O = 1\text{ to }150\text{ mA}$	3.201		3.399	
		$I_O = 1\text{ to }150\text{ mA}$ , $T_J = -40\text{ to }125\text{ °C}$	3.168		3.432	

Table 5. Electrical characteristics (continued)

Symbol	Parameter	Test conditions	Min.	Typ.	Max.	Unit
$V_O$	Output voltage	$V_I = 4.5\text{ V}$	3.413	3.5	3.587	V
		$I_O = 1\text{ to }150\text{ mA}$	3.395		3.605	
		$I_O = 1\text{ to }150\text{ mA}, T_J = -40\text{ to }125\text{ }^\circ\text{C}$	3.360		3.640	
$V_O$	Output voltage	$V_I = 4.6\text{ V}$	3.51	3.6	3.69	V
		$I_O = 1\text{ to }150\text{ mA}$	3.492		3.708	
		$I_O = 1\text{ to }150\text{ mA}, T_J = -40\text{ to }125\text{ }^\circ\text{C}$	3.456		3.744	
$V_O$	Output voltage	$V_I = 4.8\text{ V}$	3.705	3.8	3.895	V
		$I_O = 1\text{ to }150\text{ mA}$	3.686		3.914	
		$I_O = 1\text{ to }150\text{ mA}, T_J = -40\text{ to }125\text{ }^\circ\text{C}$	3.648		3.952	
$V_O$	Output voltage	$V_I = 5.0\text{ V}$	3.900	4	4.100	V
		$I_O = 1\text{ to }150\text{ mA}$	3.88		4.12	
		$I_O = 1\text{ to }150\text{ mA}, T_J = -40\text{ to }125\text{ }^\circ\text{C}$	3.84		4.16	
$V_O$	Output voltage	$V_I = 5.7\text{ V}$	4.583	4.7	4.817	V
		$I_O = 1\text{ to }150\text{ mA}$	4.559		4.841	
		$I_O = 1\text{ to }150\text{ mA}, T_J = -40\text{ to }125\text{ }^\circ\text{C}$	4.512		4.888	
$V_O$	Output voltage	$V_I = 6.0\text{ V}$	4.875	5	5.125	V
		$I_O = 1\text{ to }150\text{ mA}$	4.85		5.15	
		$I_O = 1\text{ to }150\text{ mA}, T_J = -40\text{ to }125\text{ }^\circ\text{C}$	4.8		5.2	
$I_{SC}$	Short circuit current	$R_L = 0$		400		mA
$\Delta V_O/\Delta V_I$	Line regulation	$V_I = V_O + 1\text{ V to }16\text{ V}, I_O = 1\text{ mA}$		0.003	0.014	%/ $V_I$
		$V_I = V_O + 1\text{ V to }16\text{ V}, I_O = 1\text{ mA}, T_J = -40\text{ to }125\text{ }^\circ\text{C}$			0.032	
$V_{DROP}$	Dropout voltage	$I_O = 0$		1	3	mV
		$I_O = 0, T_J = -40\text{ to }125\text{ }^\circ\text{C}$			5	
		$I_O = 1\text{ mA}$		7	10	
		$I_O = 1\text{ mA}, T_J = -40\text{ to }125\text{ }^\circ\text{C}$			15	
		$I_O = 10\text{ mA}$		40	60	
		$I_O = 10\text{ mA}, T_J = -40\text{ to }125\text{ }^\circ\text{C}$			90	
		$I_O = 50\text{ mA}$		120	150	
		$I_O = 50\text{ mA}, T_J = -40\text{ to }125\text{ }^\circ\text{C}$			225	
		$I_O = 150\text{ mA}$		280	350	
		$I_O = 150\text{ mA}, T_J = -40\text{ to }125\text{ }^\circ\text{C}$			575	

Table 5. Electrical characteristics (continued)

Symbol	Parameter	Test conditions	Min.	Typ.	Max.	Unit
I <sub>Q</sub>	Quiescent current ON MODE	I <sub>O</sub> = 0		80	100	μA
		I <sub>O</sub> = 0, T <sub>J</sub> = -40 to 125 °C			150	
		I <sub>O</sub> = 1 mA		100	150	
		I <sub>O</sub> = 1 mA, T <sub>J</sub> = -40 to 125 °C			200	
		I <sub>O</sub> = 10 mA		200	300	
		I <sub>O</sub> = 10 mA, T <sub>J</sub> = -40 to 125 °C			400	
		I <sub>O</sub> = 50 mA		600	900	
		I <sub>O</sub> = 50 mA, T <sub>J</sub> = -40 to 125 °C			1200	
		I <sub>O</sub> = 150 mA		2000	3000	
		I <sub>O</sub> = 150 mA, T <sub>J</sub> = -40 to 125 °C			4000	
	OFF MODE	V <sub>INH</sub> <0.18 V			0	
V <sub>INH</sub> <0.18 V, T <sub>J</sub> = -40 to 125 °C					2	
SVR	Supply voltage rejection	C <sub>BYP</sub> = 0.01 μF, C <sub>O</sub> = 10 μF, f = 1 kHz		45		dB
V <sub>IL</sub>	Inhibit input logic low	T <sub>J</sub> = -40 to 125 °C			0.15	V
V <sub>IH</sub>	Inhibit input logic high	T <sub>J</sub> = -40 to 125 °C	2			V
I <sub>INH</sub>	Inhibit input current	V <sub>INH</sub> = 0 V, T <sub>J</sub> = -40 to 125 °C		5	15	μA
		V <sub>INH</sub> = 5 V, T <sub>J</sub> = -40 to 125 °C		0	-1	
e <sub>N</sub>	Output noise voltage	B = 300 Hz to 50 kHz, C <sub>BYP</sub> = 0.01 μF, C <sub>O</sub> = 10 μF		30		μV



## 5 Typical characteristics

$T_J = 25\text{ }^\circ\text{C}$ ,  $V_I = V_{O(NOM)} + 1\text{ V}$ ,  $C_I = 1\text{ }\mu\text{F(X7R)}$ ,  $C_O = 2.2\text{ }\mu\text{F(X7R)}$ ,  $V_{INH} = 2\text{ V}$ , unless otherwise specified.

**Figure 3. Output voltage vs. temperature**  
( $V_O = 2.5\text{ V}$ )

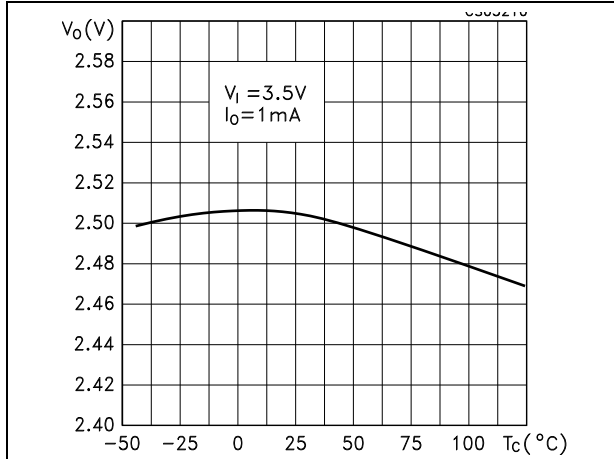

**Figure 4. Dropout voltage vs. temperature**  
( $V_O = 2.5\text{ V}$ )

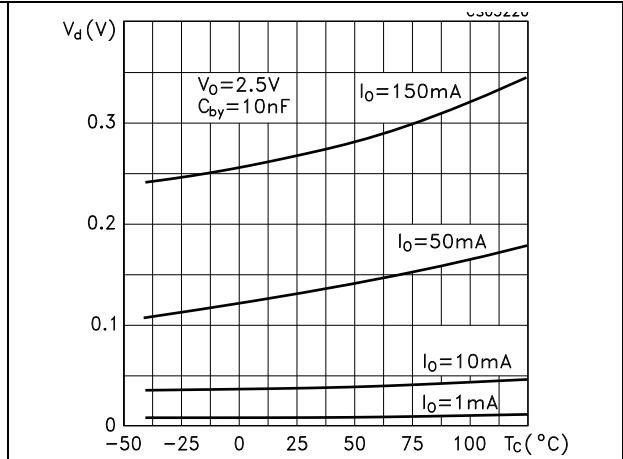

**Figure 5. Dropout voltage vs. output current**

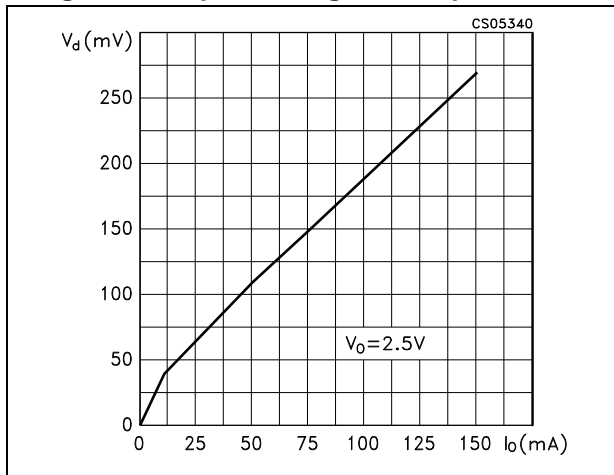

**Figure 6. Quiescent current vs. load current**

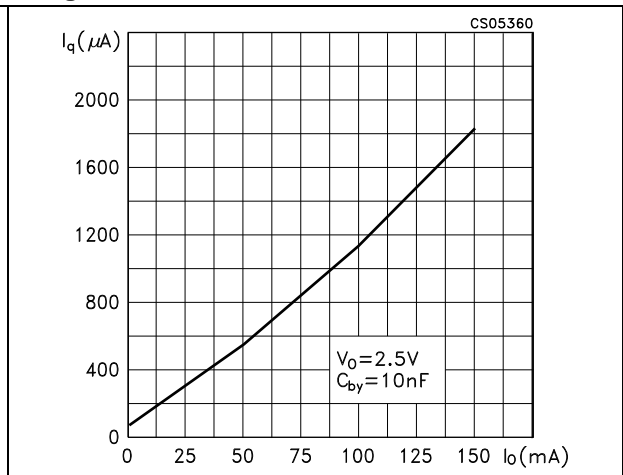

Figure 7. Quiescent current vs. temperature

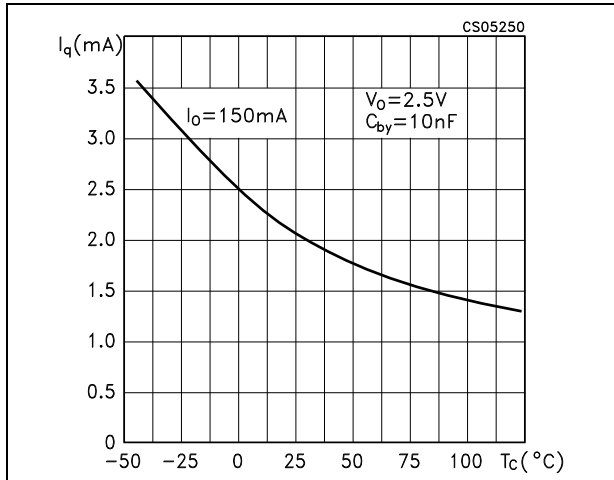

Figure 8. Supply voltage rejection vs. temp.

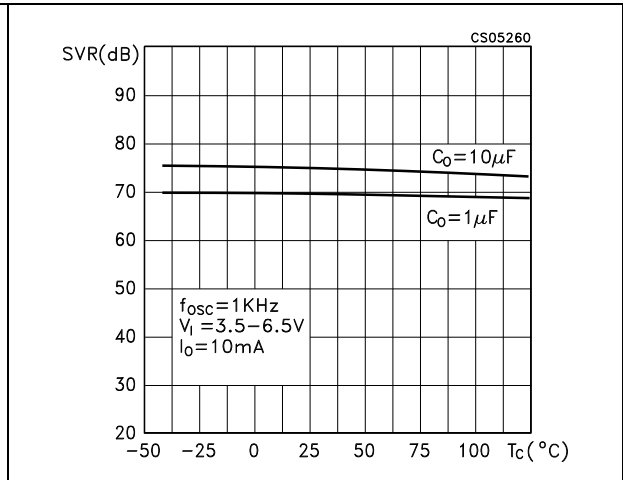

Figure 9. Supply voltage rejection vs. output current ( $C_o = 10 \mu\text{F}$ )

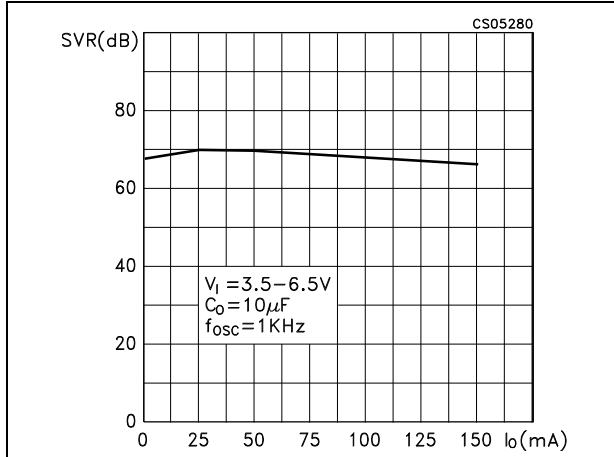

Figure 10. Supply voltage rejection vs. output current ( $C_o = 1 \mu\text{F}$ )

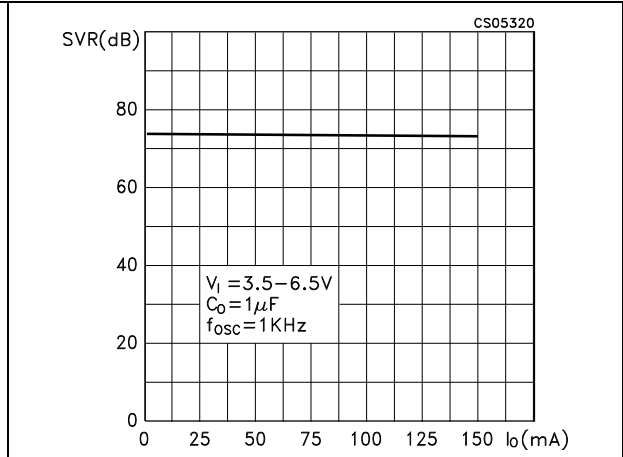

Figure 11. Supply voltage rejection vs. frequency ( $C_o = 10 \mu\text{F}$ )

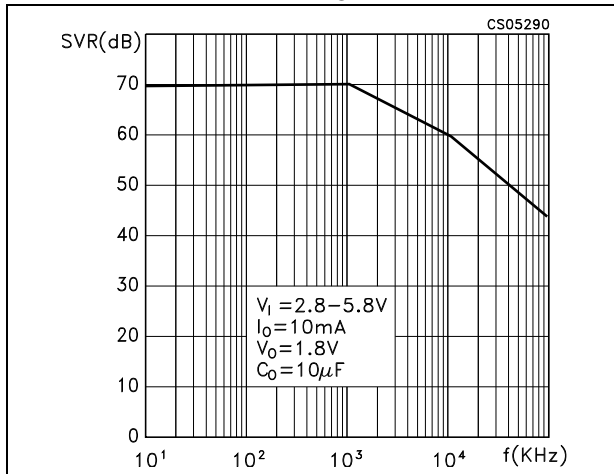

Figure 12. Supply voltage rejection vs. frequency ( $C_o = 1 \mu\text{F}$ )

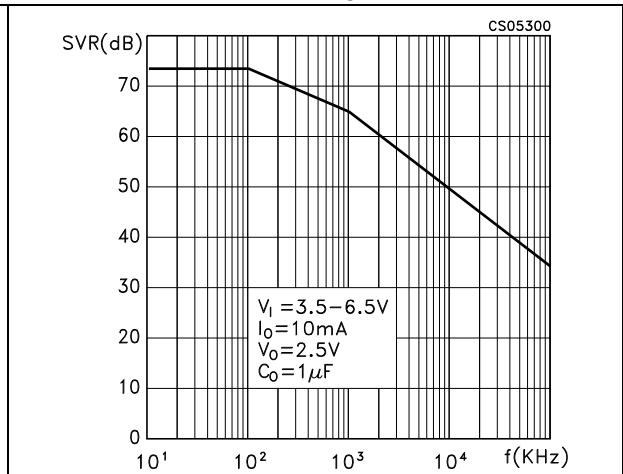
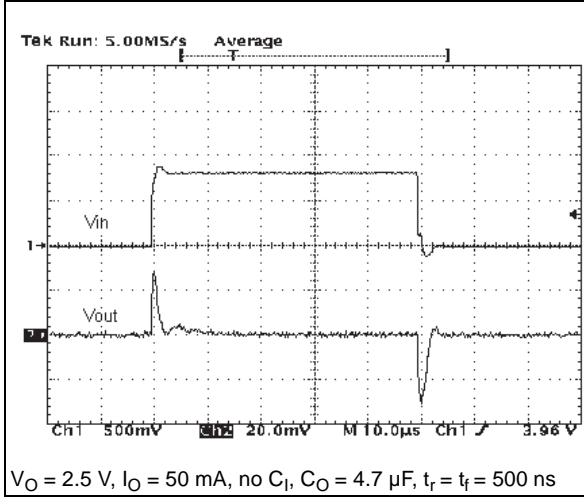
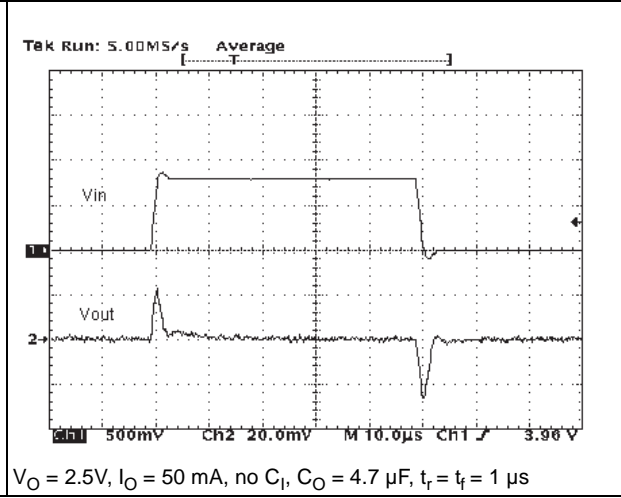

Figure 13. Line transient ( $t_r = t_f = 500$  ns)



$V_O = 2.5$  V,  $I_O = 50$  mA, no  $C_I$ ,  $C_O = 4.7$   $\mu$ F,  $t_r = t_f = 500$  ns

Figure 14. Line transient ( $t_r = t_f = 1$   $\mu$ s)



$V_O = 2.5$  V,  $I_O = 50$  mA, no  $C_I$ ,  $C_O = 4.7$   $\mu$ F,  $t_r = t_f = 1$   $\mu$ s

Figure 15. Load transient ( $C_O = 10$   $\mu$ F)

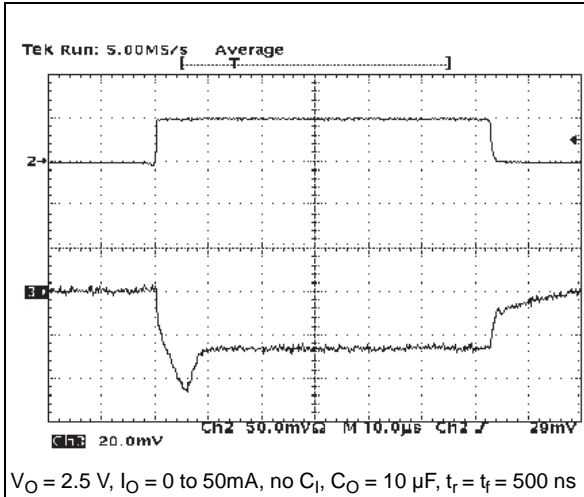

$V_O = 2.5$  V,  $I_O = 0$  to 50 mA, no  $C_I$ ,  $C_O = 10$   $\mu$ F,  $t_r = t_f = 500$  ns

Figure 16. Load transient ( $C_O = 4.7$   $\mu$ F)

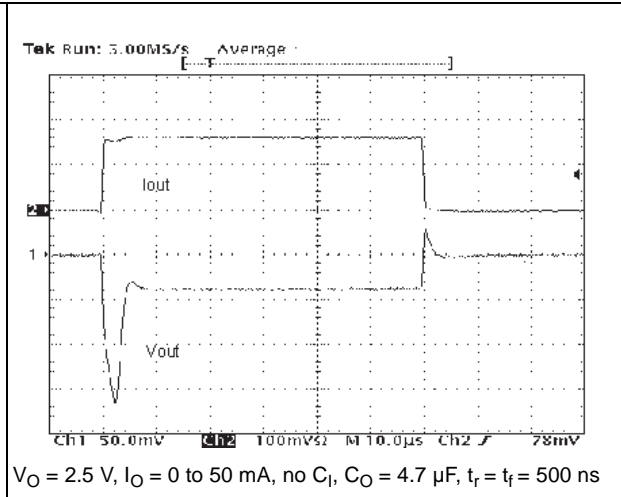

$V_O = 2.5$  V,  $I_O = 0$  to 50 mA, no  $C_I$ ,  $C_O = 4.7$   $\mu$ F,  $t_r = t_f = 500$  ns

## 6 Application notes

### 6.1 External capacitors

Like any low-dropout regulator, the LD2985 requires external capacitors for regulator stability. This capacitor must be selected to meet the requirements of minimum capacitance and equivalent series resistance. We suggest to solder input and output capacitors as close as possible to the relative pins.

### 6.2 Input capacitor

An input capacitor whose value is 1  $\mu\text{F}$  is required with the LD2985 (amount of capacitance can be increased without limit). This capacitor must be located a distance of not more than 0.5" from the input pin of the device and returned to a clean analog ground. Any good quality ceramic, tantalum or film capacitors can be used for this capacitor.

### 6.3 Output capacitor

The LD2985 is designed specifically to work with ceramic output capacitors. It may also be possible to use Tantalum capacitors, but these are not as attractive for reasons of size and cost. By the way, the output capacitor must meet both the requirement for minimum amount of capacitance and ESR (equivalent series resistance) value. Due to the different loop gain, the stability improves for higher output versions and so the suggested minimum output capacitor value, if low ESR ceramic type is used, is 1  $\mu\text{F}$  for output voltages equal or major than 3.8 V, 2.2  $\mu\text{F}$  for  $V_{\text{O}}$  going from 1.8 to 3.3 V, and 3.3  $\mu\text{F}$  for the other versions. However, if an output capacitor lower than the suggested one is used, it's possible to make stable the regulator adding a resistor in series to the capacitor.

### 6.4 Important

The output capacitor must maintain its ESR in the stable region over the full operating temperature to assure stability. Also, capacitor tolerance and variation with temperature must be considered to assure the minimum amount of capacitance is provided at all times. This capacitor should be located not more than 0.5" from the output pin of the device and returned to a clean analog ground.

### 6.5 Inhibit input operation

The inhibit pin can be used to turn OFF the regulator when pulled low, so drastically reducing the current consumption down to less than 1  $\mu\text{A}$ . When the inhibit feature is not used, this pin must be tied to  $V_{\text{I}}$  to keep the regulator output ON at all times. To assure proper operation, the signal source used to drive the inhibit pin must be able to swing above and below the specified thresholds listed in the electrical characteristics section under  $V_{\text{IH}}$   $V_{\text{IL}}$ . Any slew rate can be used to drive the inhibit.

## 6.6 Reverse current

The power transistor used in the LD2985 has not an inherent diode connected between the regulator input and output. If the output is forced above the input, no current will flow from the output to the input across the series pass transistor. When a  $V_{REV}$  voltage is applied on the output, the reverse current measured flows to the GND across the two feedback resistors. This current typical value is  $160 \mu\text{A}$ .  $R_1$  and  $R_2$  resistors are implanted type; typical values are, respectively,  $42.6 \text{ k}\Omega$  and  $51.150 \text{ k}\Omega$ .

Figure 17. Reverse current test circuit

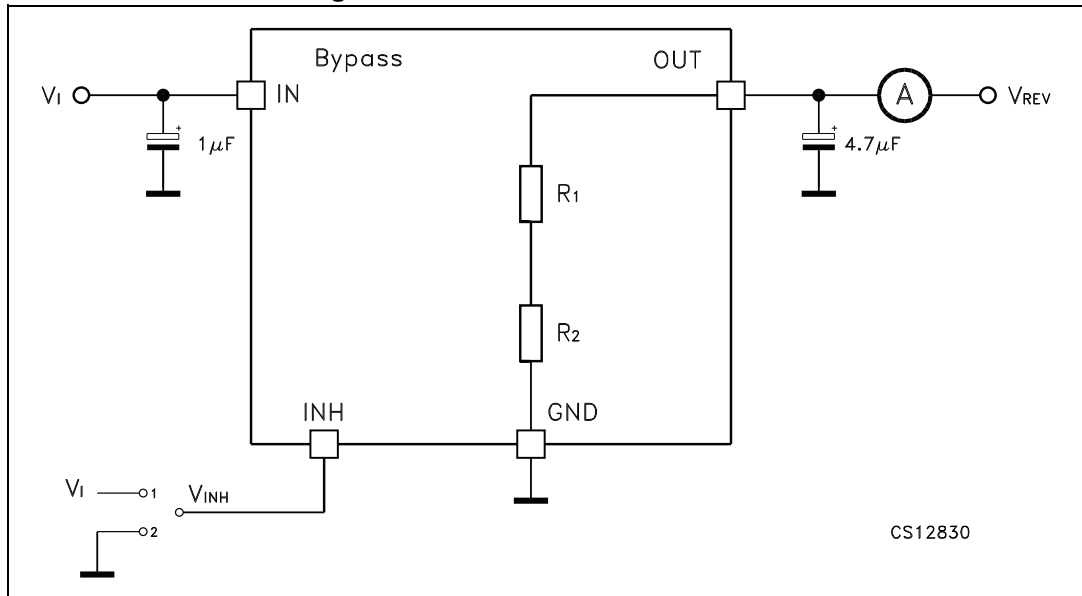

## 7 Package mechanical data

In order to meet environmental requirements, ST offers these devices in different grades of ECOPACK® packages, depending on their level of environmental compliance. ECOPACK® specifications, grade definitions and product status are available at: [www.st.com](http://www.st.com). ECOPACK® is an ST trademark.

**Table 6. SOT23-5L mechanical data**

Dim.	mm		
	Min.	Typ.	Max.
A	0.90		1.45
A1	0		0.15
A2	0.90		1.30
b	0.30		0.50
c	2.09		0.20
D		2.95	
E		1.60	
e		0.95	
H		2.80	
L	0.30		0.60
$\theta$	0		8

Figure 18. SOT23-5L mechanical drawing

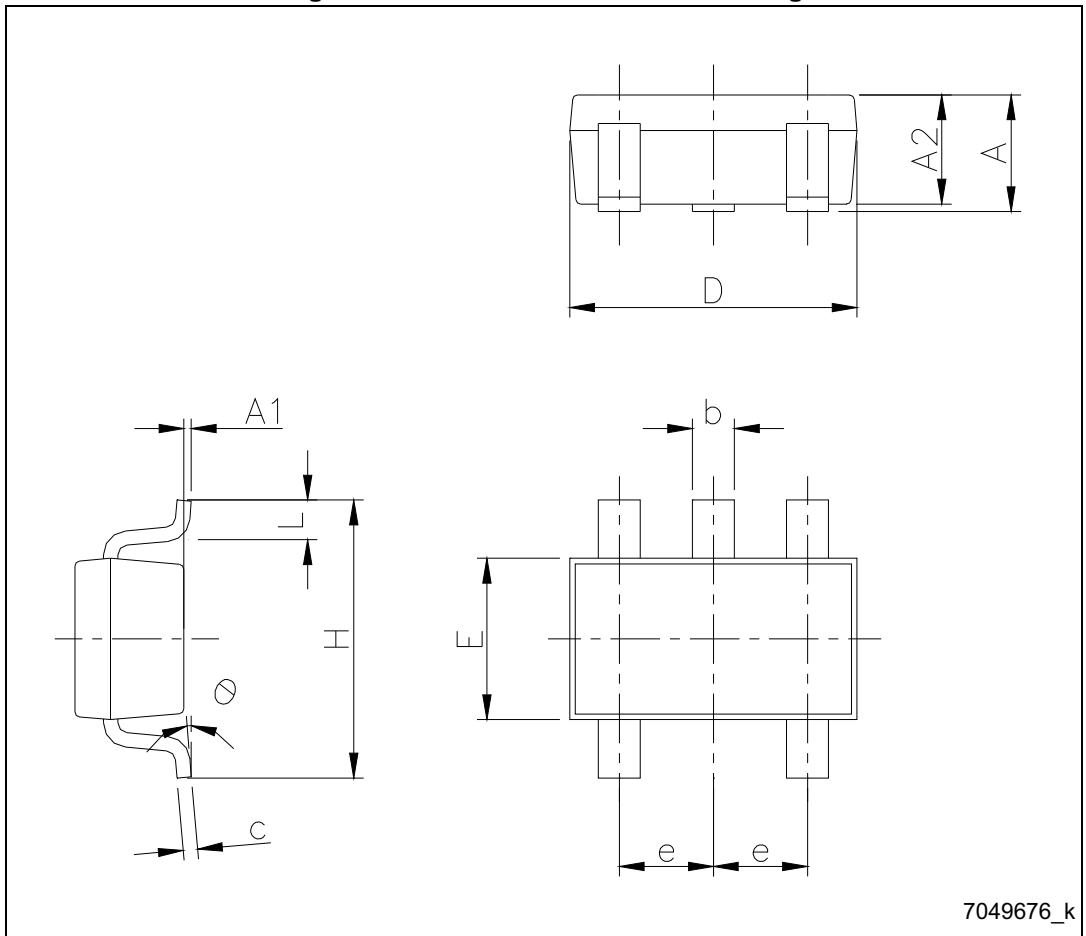

7049676\_k

Figure 19. SOT23-5L recommended footprint (dimensions in mm)

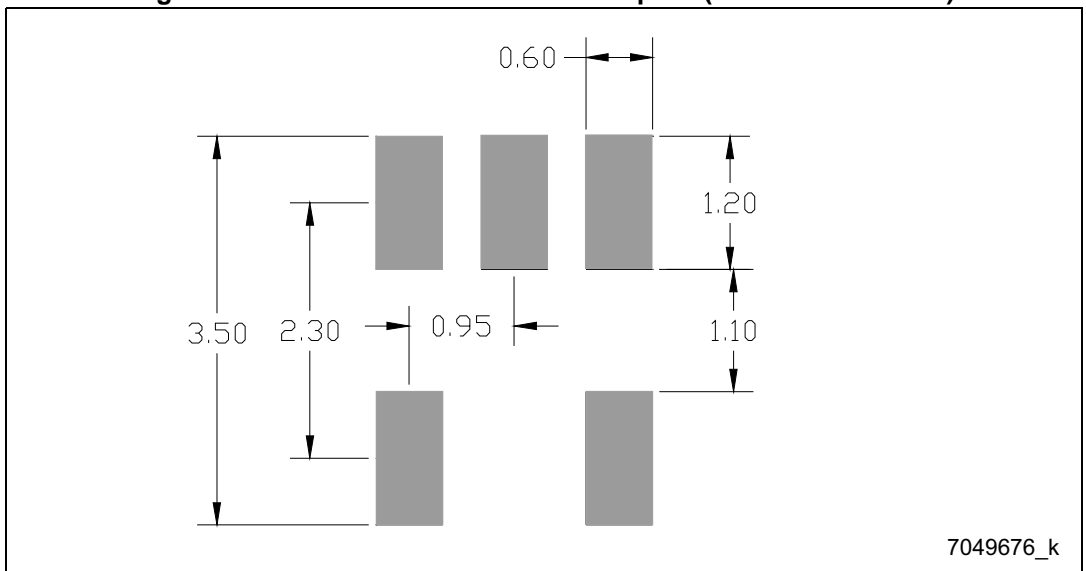

7049676\_k

## 8 Packaging mechanical data

Table 7. Tape and reel SOT23-5L mechanical data

Dim.	mm		
	Min.	Typ.	Max.
A			180
C	12.8	13.0	13.2
D	20.2		
N	60		
T			14.4
Ao	3.13	3.23	3.33
Bo	3.07	3.17	3.27
Ko	1.27	1.37	1.47
Po	3.9	4.0	4.1
P	3.9	4.0	4.1

Figure 20. Tape and reel SOT23-5L mechanical drawing

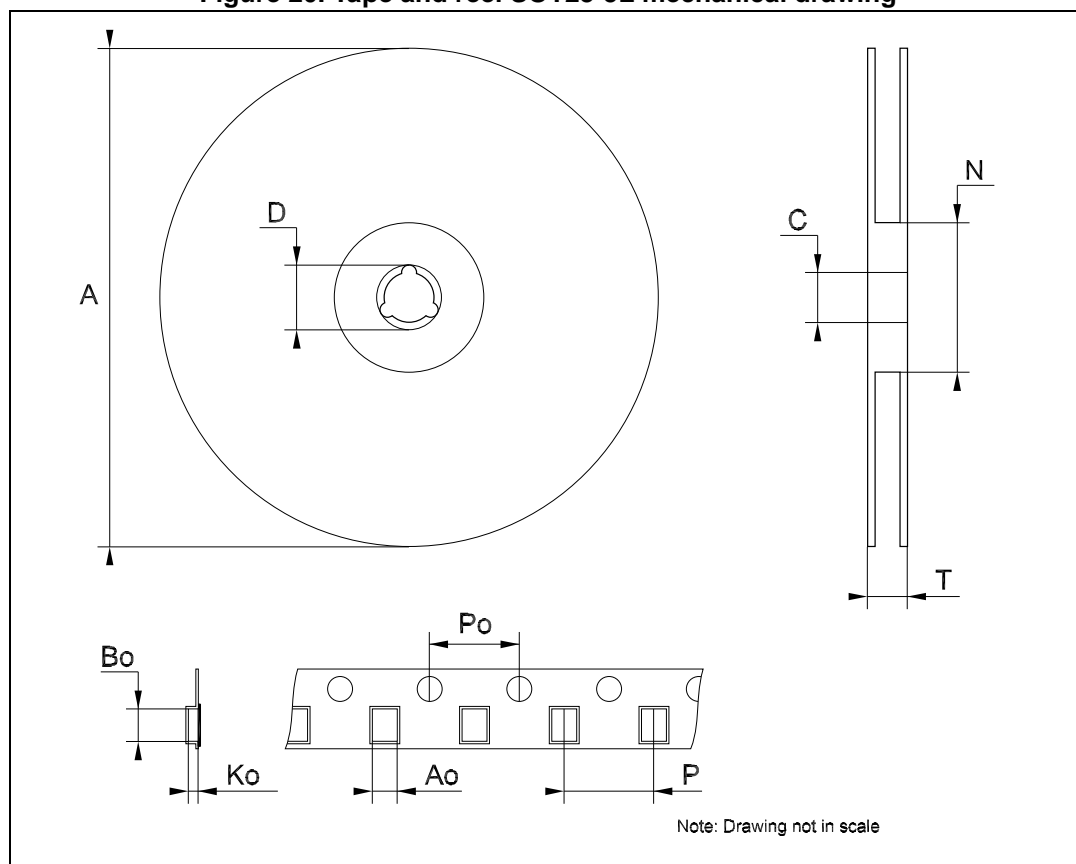



## 9 Revision history

**Table 8. Document revision history**

Date	Revision	Changes
22-Aug-2005	4	Add new value $V_O \Rightarrow 2.7$ V on tables 5 and 6.
02-Sep-2005	5	Mistake $V_O$ min. $\Rightarrow 2.7$ V on table 5.
25-Jul-2006	6	Order codes updated.
13-Feb-2008	7	Added: <a href="#">Table 1 on page 1</a> .
04-Mar-2008	8	Modified: <a href="#">Table 5 on page 6</a> .
10-Jul-2008	9	Modified: <a href="#">Table 1 on page 1</a> and <a href="#">Table 5 on page 6</a> .
27-Aug-2008	10	Modified: <a href="#">Features on page 1</a> .
27-Jan-2009	11	Modified: <a href="#">Features on page 1</a> .
09-Feb-2012	12	Modified: pin inhibit <a href="#">Figure 1 on page 3</a> . Removed: order codes and electrical characteristics table for type A.
12-Nov-2013	13	RPN LD2985Bxx changed to LD2985. Updated the Title and the Description in cover page. Modified <a href="#">Table 1: Device summary</a> , the title of the <a href="#">Figure 3: Output voltage vs. temperature (<math>V_O = 2.5</math> V)</a> and <a href="#">Section 7: Package mechanical data</a> Added <a href="#">Section 8: Packaging mechanical data</a> Minor text changes.

**Please Read Carefully:**

Information in this document is provided solely in connection with ST products. STMicroelectronics NV and its subsidiaries ("ST") reserve the right to make changes, corrections, modifications or improvements, to this document, and the products and services described herein at any time, without notice.

All ST products are sold pursuant to ST's terms and conditions of sale.

Purchasers are solely responsible for the choice, selection and use of the ST products and services described herein, and ST assumes no liability whatsoever relating to the choice, selection or use of the ST products and services described herein.

No license, express or implied, by estoppel or otherwise, to any intellectual property rights is granted under this document. If any part of this document refers to any third party products or services it shall not be deemed a license grant by ST for the use of such third party products or services, or any intellectual property contained therein or considered as a warranty covering the use in any manner whatsoever of such third party products or services or any intellectual property contained therein.

**UNLESS OTHERWISE SET FORTH IN ST'S TERMS AND CONDITIONS OF SALE ST DISCLAIMS ANY EXPRESS OR IMPLIED WARRANTY WITH RESPECT TO THE USE AND/OR SALE OF ST PRODUCTS INCLUDING WITHOUT LIMITATION IMPLIED WARRANTIES OF MERCHANTABILITY, FITNESS FOR A PARTICULAR PURPOSE (AND THEIR EQUIVALENTS UNDER THE LAWS OF ANY JURISDICTION), OR INFRINGEMENT OF ANY PATENT, COPYRIGHT OR OTHER INTELLECTUAL PROPERTY RIGHT.**

**ST PRODUCTS ARE NOT DESIGNED OR AUTHORIZED FOR USE IN: (A) SAFETY CRITICAL APPLICATIONS SUCH AS LIFE SUPPORTING, ACTIVE IMPLANTED DEVICES OR SYSTEMS WITH PRODUCT FUNCTIONAL SAFETY REQUIREMENTS; (B) AERONAUTIC APPLICATIONS; (C) AUTOMOTIVE APPLICATIONS OR ENVIRONMENTS, AND/OR (D) AEROSPACE APPLICATIONS OR ENVIRONMENTS. WHERE ST PRODUCTS ARE NOT DESIGNED FOR SUCH USE, THE PURCHASER SHALL USE PRODUCTS AT PURCHASER'S SOLE RISK, EVEN IF ST HAS BEEN INFORMED IN WRITING OF SUCH USAGE, UNLESS A PRODUCT IS EXPRESSLY DESIGNATED BY ST AS BEING INTENDED FOR "AUTOMOTIVE, AUTOMOTIVE SAFETY OR MEDICAL" INDUSTRY DOMAINS ACCORDING TO ST PRODUCT DESIGN SPECIFICATIONS. PRODUCTS FORMALLY ESCC, QML OR JAN QUALIFIED ARE DEEMED SUITABLE FOR USE IN AEROSPACE BY THE CORRESPONDING GOVERNMENTAL AGENCY.**

Resale of ST products with provisions different from the statements and/or technical features set forth in this document shall immediately void any warranty granted by ST for the ST product or service described herein and shall not create or extend in any manner whatsoever, any liability of ST.

ST and the ST logo are trademarks or registered trademarks of ST in various countries.

Information in this document supersedes and replaces all information previously supplied.

The ST logo is a registered trademark of STMicroelectronics. All other names are the property of their respective owners.

© 2013 STMicroelectronics - All rights reserved

STMicroelectronics group of companies

Australia - Belgium - Brazil - Canada - China - Czech Republic - Finland - France - Germany - Hong Kong - India - Israel - Italy - Japan - Malaysia - Malta - Morocco - Philippines - Singapore - Spain - Sweden - Switzerland - United Kingdom - United States of America

[www.st.com](http://www.st.com)