

4-line ESD protection for high speed lines

Datasheet - production data

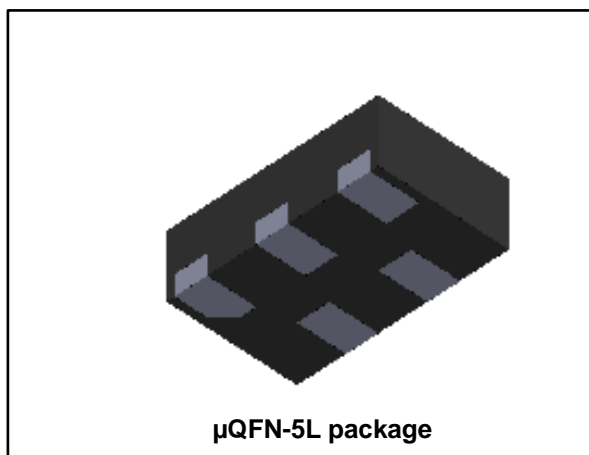

Applications

The HSP053-4M5 is designed to protect against to electro-static discharge sub-micron technology circuits driving:

- HDMI 1.4 and HDMI 2.0
- USB 3.1 Gen 1 and Gen 2
- Digital video interface
- Display port
- Serial ATA

The ultra-low variation of the capacitance ensures very low influence on signal-skew. The large bandwidth makes it compatible with HDMI 2.0 (= 5.94 Gbps) and USB 3.1 Gen 2 (= 10 Gbps).

Features

- Very compact 500 μm pitch package, for easy PCB layout
- Ultra-large bandwidth: 18 GHz
- Ultra-low capacitance: 0.15 pF (I/O to I/O) and 0.25 pF (I/O to GND)
- Low leakage current: < 1 nA
- Extended operating junction temperature range: -40 °C to 150 °C
- Thin package: 0.4 mm max.
- RoHS compliant

Benefits

- High ESD protection level
- High integration
- Suitable for high density boards

Complies with the following standards

- MIL-STD 883G method 3015-7 class 3B > 8 kV
- Exceeds IEC61000-4-2 level 4
 - ±10 kV (contact discharge)
 - ±25 kV (air discharge)

Description

The HSP053-4M5 is a 4 channel ESD array with a rail to rail architecture designed specifically for the protection of high speed differential lines.

The device is packaged in μQFN 1.3 mm x 0.8 mm with a 500 μm pitch.

Figure 1: Functional diagram

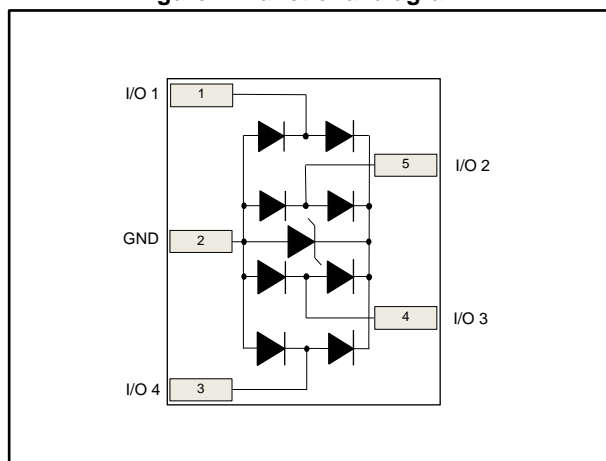

1 Characteristics

Table 1: Absolute maximum ratings ($T_{amb} = 25\text{ }^{\circ}\text{C}$)

Symbol	Parameter		Value	Unit
V_{PP}	Peak pulse voltage	Contact discharge	10	kV
		Air discharge	25	
T_{stg}	Storage temperature range		-65 to +150	$^{\circ}\text{C}$
T_j	Operating junction temperature range		-40 to +150	
T_L	Maximum lead temperature for soldering during 10 s		260	

Table 2: Electrical characteristics ($T_{amb} = 25\text{ }^{\circ}\text{C}$)

Symbol	Test condition		Min.	Typ.	Max.	Unit
V_{BR}	$I_R = 1\text{ mA}$		5.3	5.8		V
V_{RM}					5.0	
I_{RM}	$V_{RM} = 3.6\text{ V}$			< 1	50	nA
	$V_{RM} = 5.0\text{ V}$			3	70	nA
V_{CL}	IEC 61000-4-2, +8 kV contact measured at 30 ns			16		V
R_d	Dynamic resistance, Pulse duration 100ns	I/O to GND		0.68		Ω
		GND to I/O		0.65		
$C_{I/O - I/O}$	$V_{I/O} = 0\text{ V}$, $V_{osc} = 30\text{ mV}$	F = 2.5 GHz to 9 GHz		0.15	0.2	pF
$C_{I/O - GND}$		F = 200 MHz to 2.5 GHz		0.35	0.5	
		F = 2.5 GHz to 9 GHz		0.25	0.4	
f_c	- 3dB			18		GHz

1.1 Characteristics (curves)

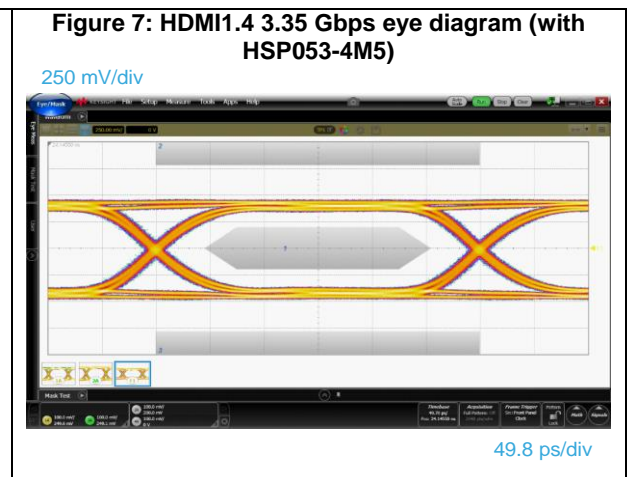
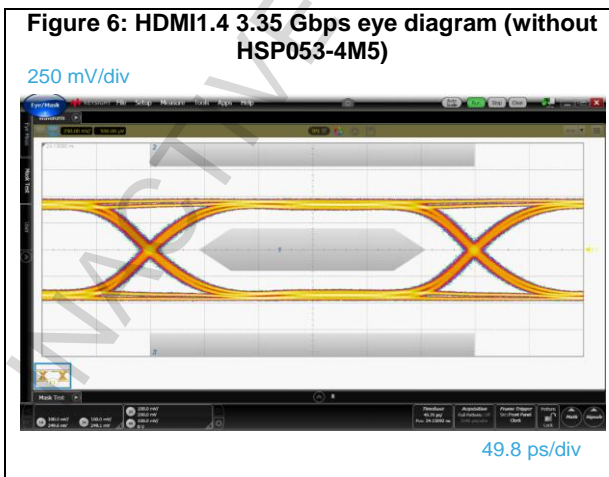
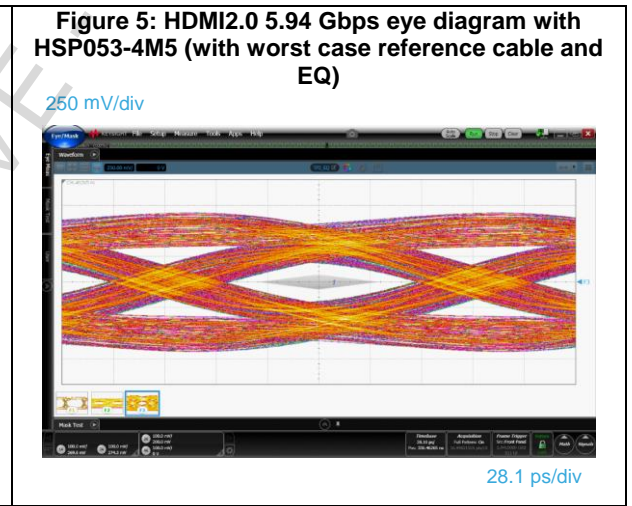
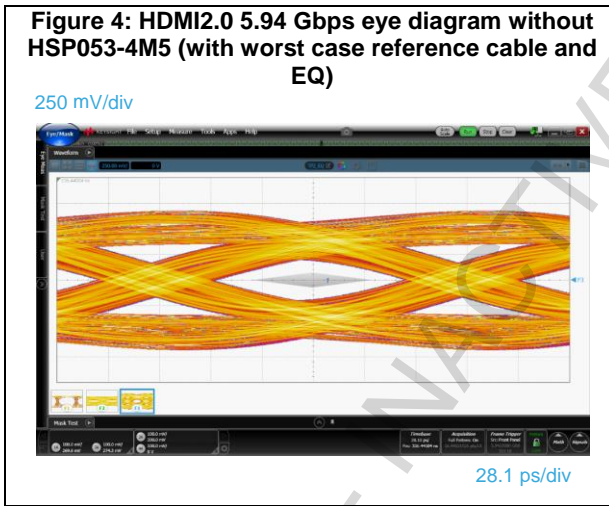
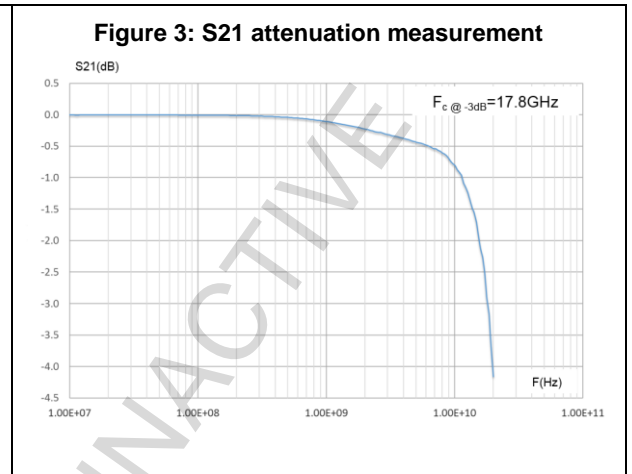
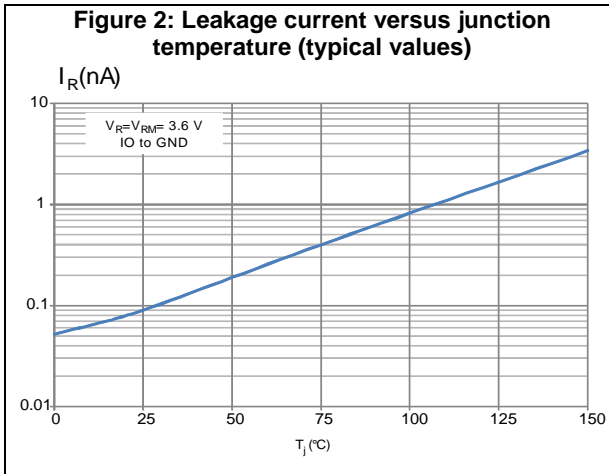

Figure 8: USB3.1 Gen2 10 Gbps eye diagram without HSP053-4M5 (with type-C connector, reference cable, EQ with ADC = 6 dB and DFE)

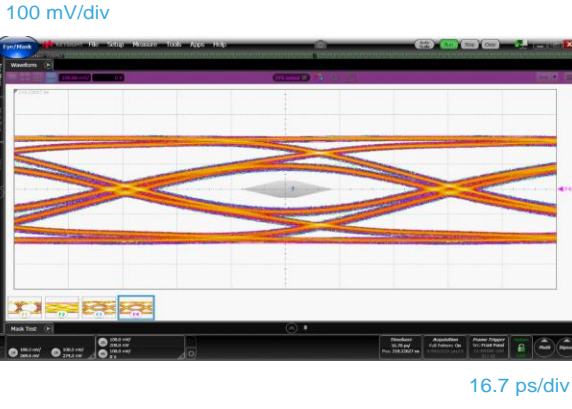

Figure 9: USB3.1 Gen2 10 Gbps eye diagram with HSP053-4M5 (with type-C connector, reference cable, EQ with ADC = 6 dB and DFE)

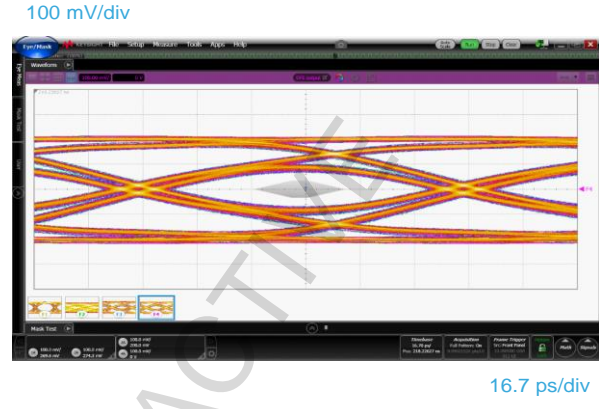

Figure 10: USB3.1 Gen1 5Gbps eye diagram without HSP053-4M5 (with Type-C connector, reference cable and EQ)

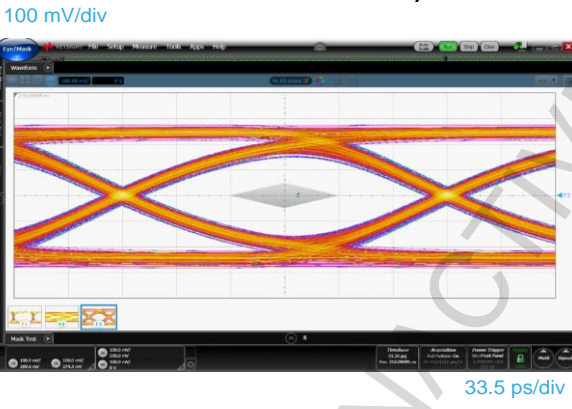

Figure 11: USB3.1 Gen1 5Gbps eye diagram with HSP053-4M5 (with Type-C connector, reference cable and EQ)

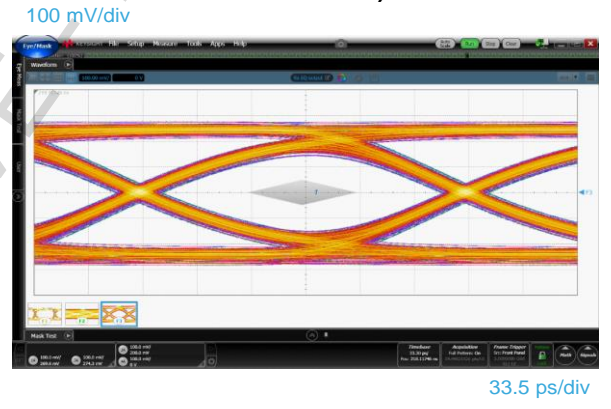

Figure 12: ESD response to IEC61000-4-2 (+8 kV contact discharge)

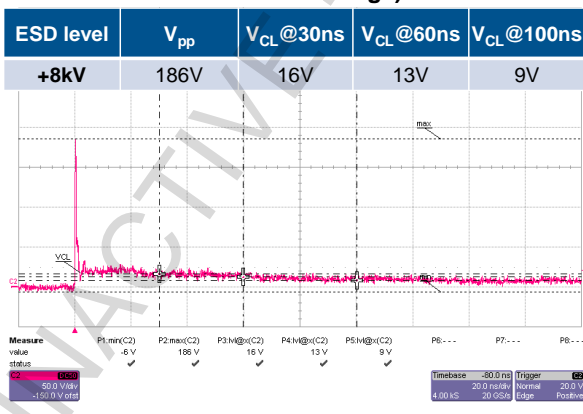
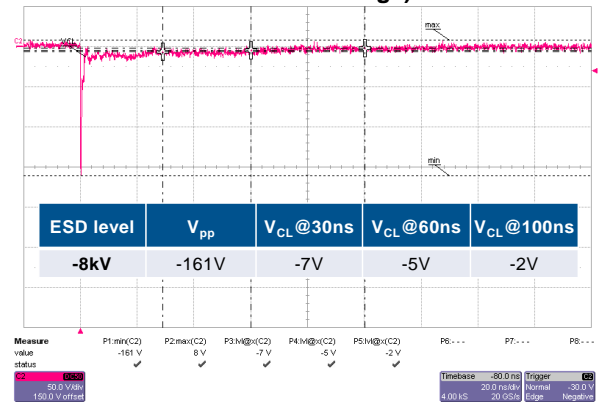
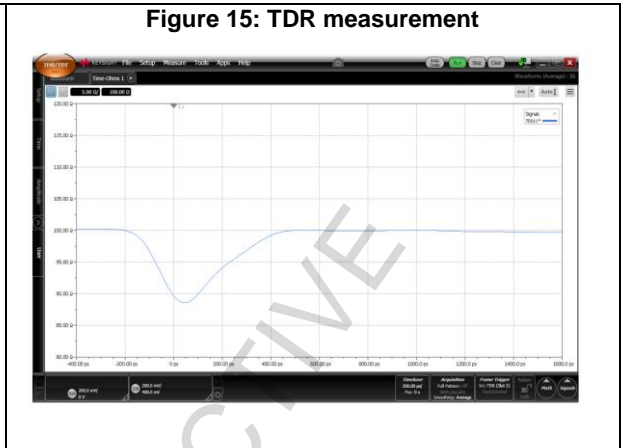
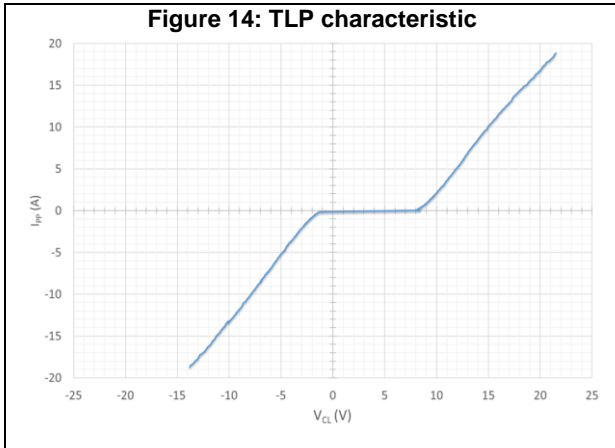

Figure 13: ESD response to IEC61000-4-2 (-8 kV contact discharge)





INACTIVE - INACTIVE - INACTIVE

2 Package information

In order to meet environmental requirements, ST offers these devices in different grades of ECOPACK® packages, depending on their level of environmental compliance. ECOPACK® specifications, grade definitions and product status are available at: www.st.com. ECOPACK® is an ST trademark.

2.1 MicroQFN-5L package information

Figure 16: MicroQFN-5L package outline

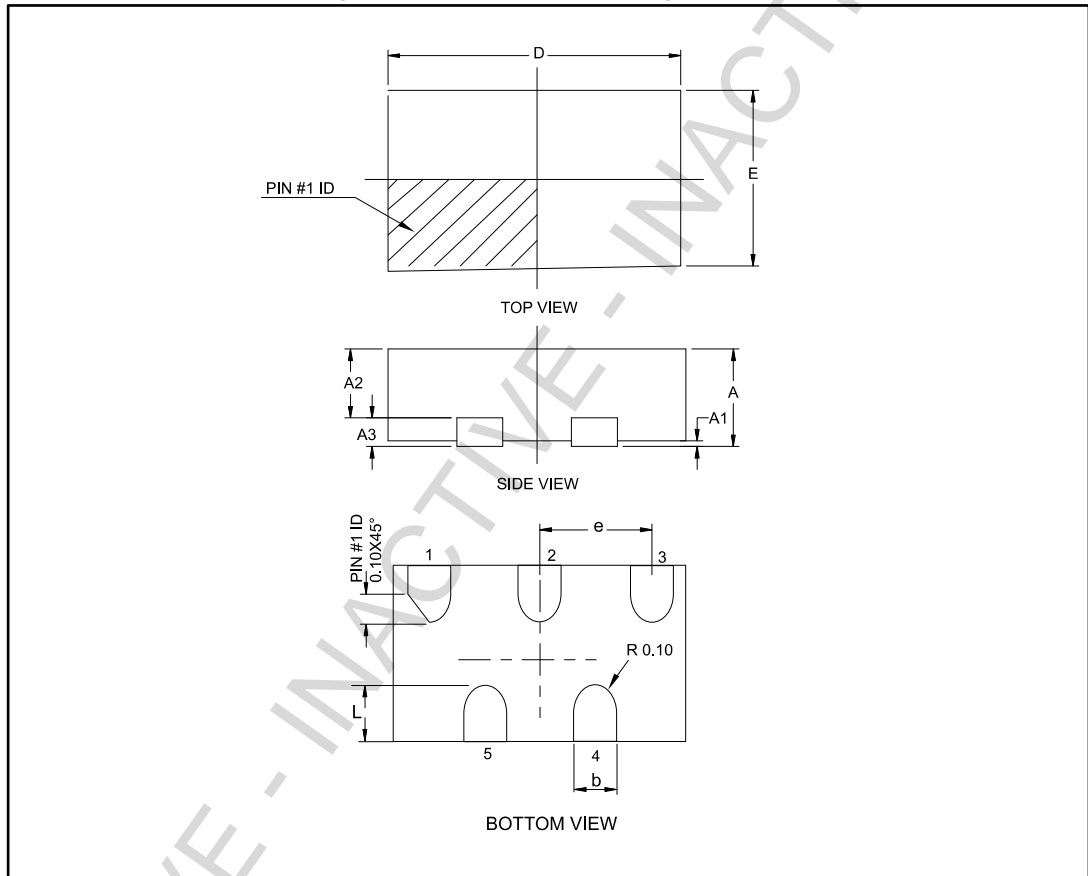

Table 3: MicroQFN-5L package mechanical data

Ref.	Dimensions					
	Millimeters			Inches		
	Min.	Typ.	Max.	Min.	Typ.	Max.
A	0.36	0.38	0.40	0.0141	0.0149	0.0157
A1	0.00	0.02	0.05	0.0000	0.0007	0.0019
A2	0.15	0.25	0.35	0.0059	0.0098	0.0137
A3		0.130			0.0051	
b	0.16	0.20	0.24	0.0062	0.0078	0.0094
D	1.20	1.30	1.40	0.0472	0.0511	0.0551
e		0.50			0.0196	
E	0.70	0.80	0.90	0.0275	0.0314	0.0354
L	0.20	0.25	0.30	0.0078	0.0098	0.0118

Figure 17: Footprint (dimensions in mm)

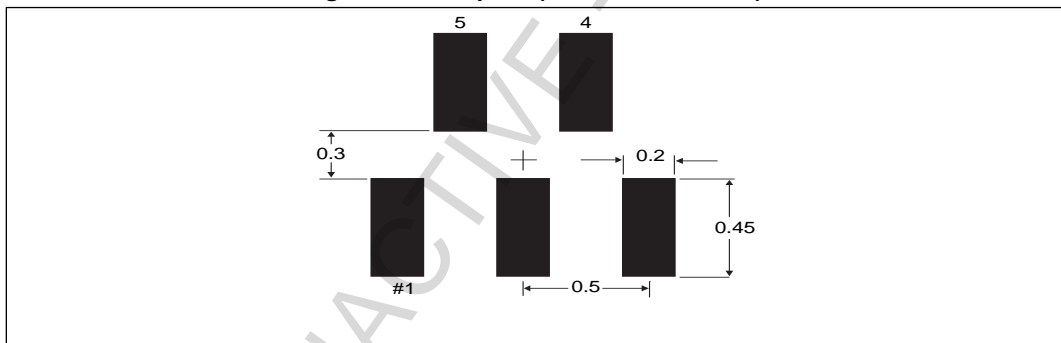

Figure 18: Marking

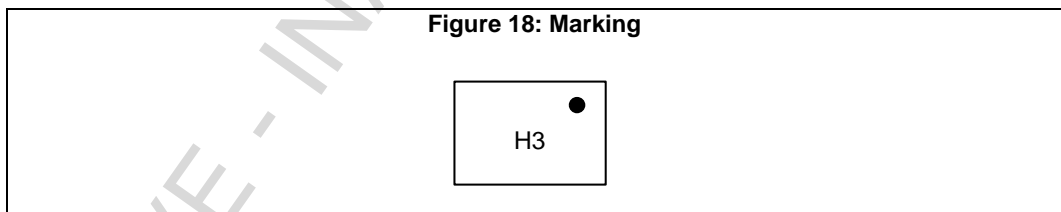
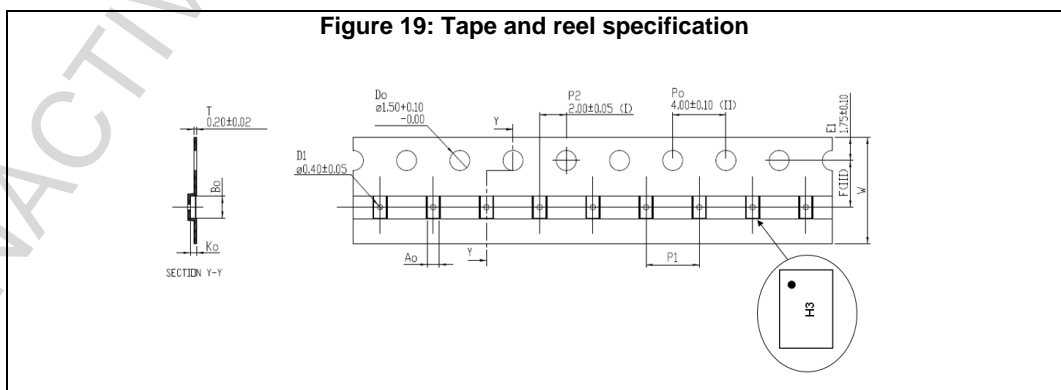

Figure 19: Tape and reel specification



3 Recommendation on PCB assembly

3.1 Solder paste

1. Halide-free flux qualification ROL0 according to ANSI/J-STD-004.
2. "No clean" solder paste is recommended.
3. Offers a high tack force to resist component movement during high speed.
4. Solder paste with fine particles: powder particle size is 20-45 μm .

3.2 Placement

1. Manual positioning is not recommended.
2. It is recommended to use the lead recognition capabilities of the placement system, not the outline centering
3. Standard tolerance of ± 0.05 mm is recommended.
4. 3.5 N placement force is recommended. Too much placement force can lead to squeezed out solder paste and cause solder joints to short. Too low placement force can lead to insufficient contact between package and solder paste that could cause open solder joints or badly centered packages.
5. To improve the package placement accuracy, a bottom side optical control should be performed with a high resolution tool.
6. For assembly, a perfect supporting of the PCB (all the more on flexible PCB) is recommended during solder paste printing, pick and place and reflow soldering by using optimized tools.

3.3 PCB design preference

1. To control the solder paste amount, the closed via is recommended instead of open vias.
2. The position of tracks and open vias in the solder area should be well balanced. A symmetrical layout is recommended, to avoid any tilt phenomena caused by asymmetrical solder paste due to solder flow away.

3.4 Reflow profile

Figure 20: ST ECOPACK® recommended soldering reflow profile for PCB mounting

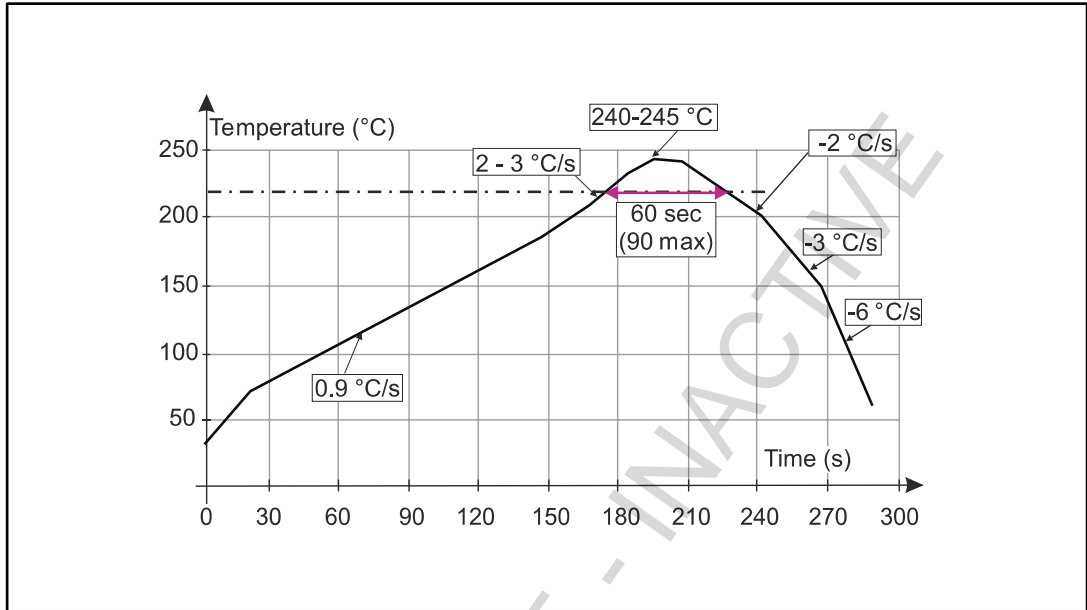

Minimize air convection currents in the reflow oven to avoid component movement.



Maximum soldering profile corresponds to the latest IPC/JEDEC J-STD-020.

4 Ordering information

Figure 21: Ordering information scheme

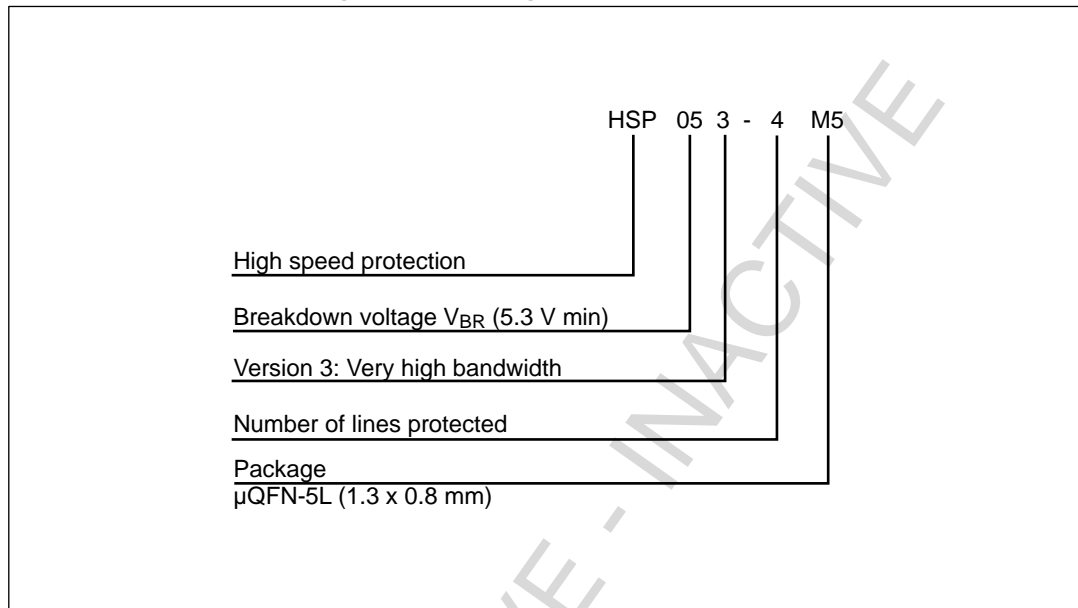

Table 4: Ordering information

Order code	Marking ⁽¹⁾	Package	Weight	Base qty.	Delivery mode
HSP053-4M5	H3	μ QFN-5L	4.24 mg	6000	Tape and reel

Notes:

⁽¹⁾The marking can be rotated by multiples of 90° to differentiate assembly location

5 Revision history

Table 5: Document revision history

Date	Revision	Changes
22-Nov-2016	1	Initial release.
21-Dec-2017	2	New product version.
29-Jan-2018	3	Updated Table 2: "Electrical characteristics (Tamb = 25 °C)" .

IMPORTANT NOTICE – PLEASE READ CAREFULLY

STMicroelectronics NV and its subsidiaries (“ST”) reserve the right to make changes, corrections, enhancements, modifications, and improvements to ST products and/or to this document at any time without notice. Purchasers should obtain the latest relevant information on ST products before placing orders. ST products are sold pursuant to ST’s terms and conditions of sale in place at the time of order acknowledgement.

Purchasers are solely responsible for the choice, selection, and use of ST products and ST assumes no liability for application assistance or the design of Purchasers’ products.

No license, express or implied, to any intellectual property right is granted by ST herein.

Resale of ST products with provisions different from the information set forth herein shall void any warranty granted by ST for such product.

ST and the ST logo are trademarks of ST. All other product or service names are the property of their respective owners.

Information in this document supersedes and replaces information previously supplied in any prior versions of this document.

© 2018 STMicroelectronics – All rights reserved