

MB1299_Microphone_MEMS_Module

MB1299

Table of contents

Sheet 1: Project overview (this page)

Sheet 2: MB1299

Legend

General comment such as function title, configuration, ...

Text to be added to silkscreen.

Warning text.

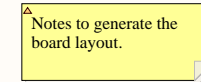

Open Platform License Agreement

The Open Platform License Agreement (“Agreement”) is a binding legal contract between you (“You”) and STMicroelectronics International N.V. (“ST”), a company incorporated under the laws of the Netherlands acting for the purpose of this Agreement through its Swiss branch 39, Chemin du Champ des Filles, 1228 Plan-les-Ouates, Geneva, Switzerland.

By using the enclosed reference designs, schematics, PC board layouts, and documentation, in hardcopy or CAD tool file format (collectively, the “Reference Material”), You are agreeing to be bound by the terms and conditions of this Agreement. Do not use the Reference Material until You have read and agreed to this Agreement terms and conditions. The use of the Reference Material automatically implies the acceptance of the Agreement terms and conditions.

The complete Open Platform License Agreement can be found on www.st.com/opla.

U_MB1299
MB1299.SchDoc



Title: Project overview		
Project: MB1299_Microphone_MEMS_Module		
Variant: Default		
Revision: B-01		Reference: MB1299
Size: A4	Date: 26/09/2016	Sheet: 1 of 2



MEMS microphones Daughter Board

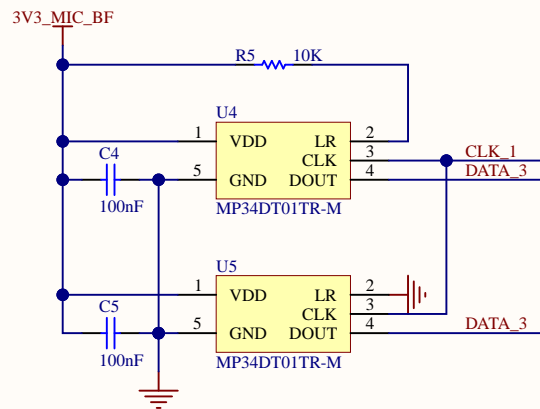
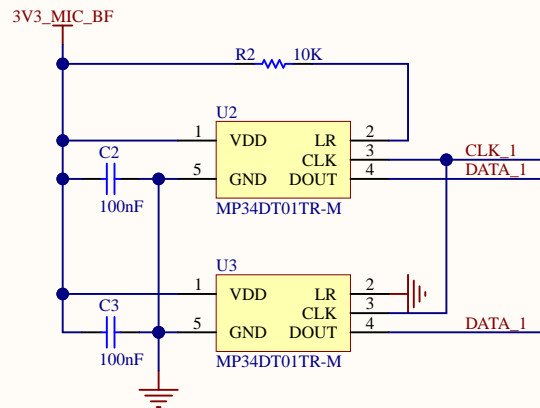
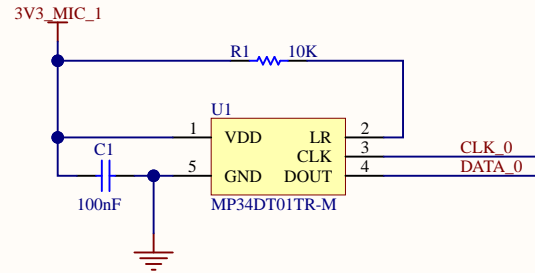

Connector

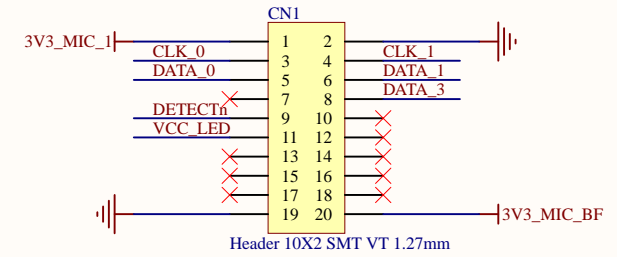

LED

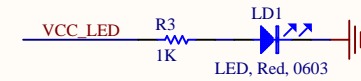

CARD DETECT

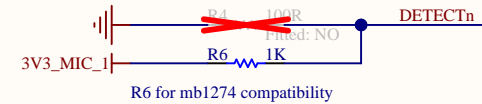

Board implementation

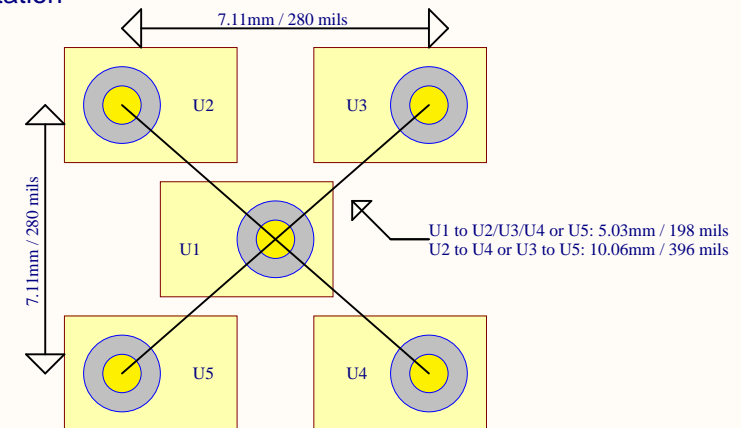

Title: MEMS	
Project: MB1299_Microphone_MEMS_Module	
Variant: Default	
Revision: B-01	
Size: A4	Reference: MB1299
Date: 26/09/2016	Sheet: 2 of 2

