



life.augmented

ST VIPerPlus 产品

家用电器中高压功率变换器辅助电源

Industrial
Power & Energy
Competence Center





VIPer122/222 专为小家电应用

优化的低功耗供电电源



- 大小家电
- 智能家居
- 智能电表
- LED照明辅助设备



主要特点

- 集成高压MOSFET
 - 730V
 - 150hm (VIPER222) , 270hm (VIPer222)
- 集成高压启动
- PWM电流模式控制器
- 嵌入式误差放大器 (E/A)

主要应用优势

- 由于抖动 · EMI滤波器很小
- 230V_{AC}条件下, 待机功率低于40mW
- 短路保护和热保护
- 更少元件数量及更小PCB尺寸
- 采用小包装SSO10

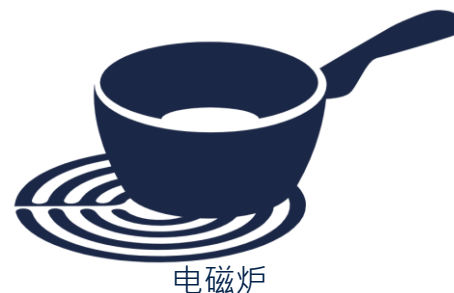

电磁炉



微波炉



智能咖啡机



洗衣机

Part #	RDSON	Buck Converter Out Current @85-265VAC	Fly Back Out Power @85-265VAC
VIPER122	27 Ohm	250mA	5W
VIPER222	15 Ohm	350mA	8W

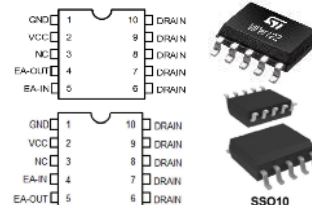

STEVAL-V12201B (Buck 15V-200mA)

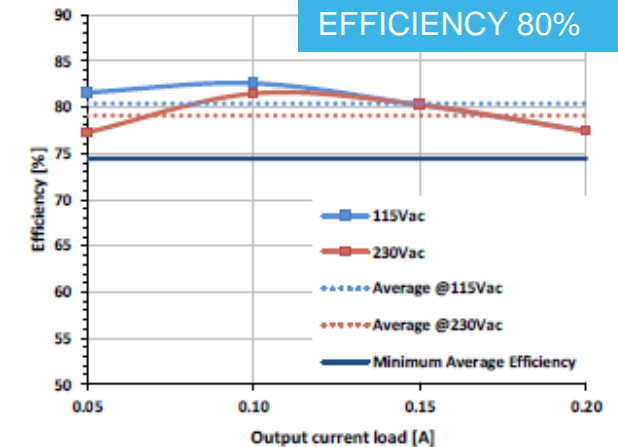
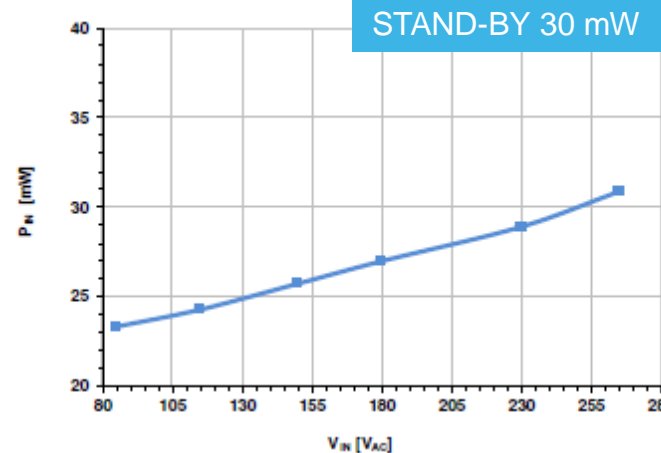
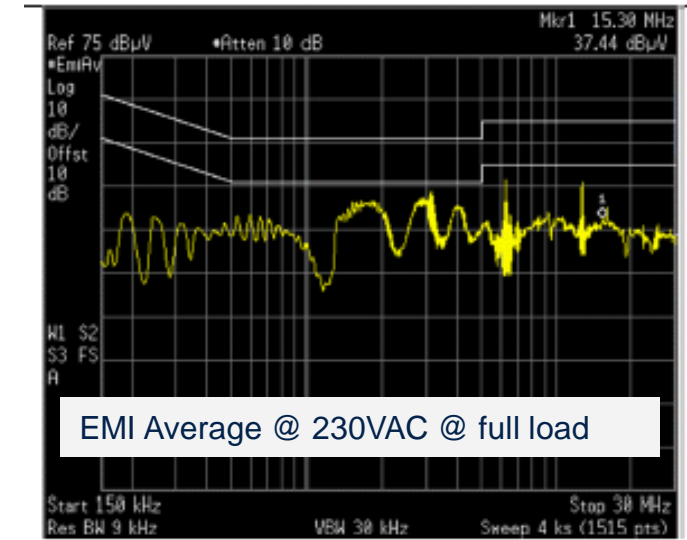
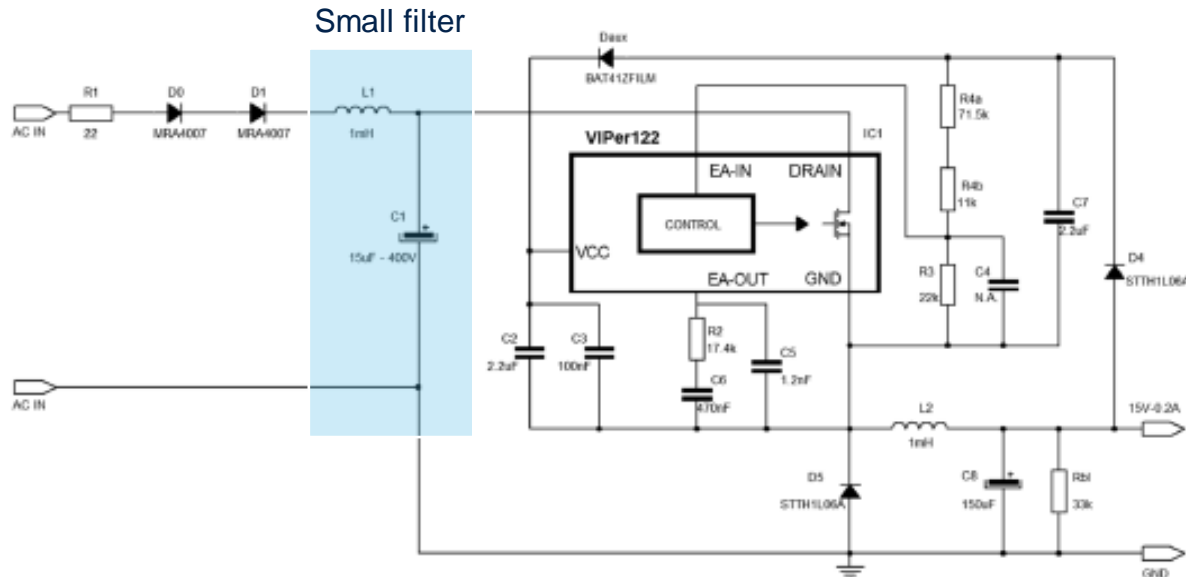



VIPerPlus 生态系统

评估工具包

超过55个评估工具包
降压, 降压-升压, 反激变换器



设计工具

eDesignSuite
The smart way to design your application



技术文档

用户手册, 规格书, 应用指南

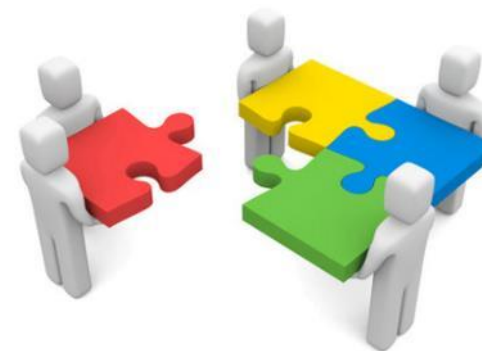

选型手册

Spreadsheets



OrCAD PSpice®

Models

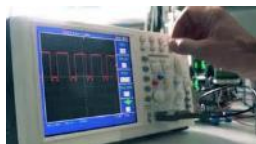

强大应用支持

设计可行性
PCB & BoM 优化
电磁干 (EMI) 扰预合规性
EMC (突发浪涌) 预合规性

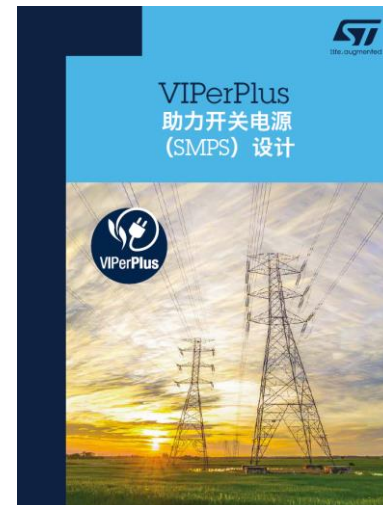

life.augmented



life.augmented

扫描以下二维码
获得功率及模拟产品更多资讯



PDSA 微信公众号



能以致动子网站

