

DVI ESD Protection demonstration board

Introduction

This document presents the ST demonstration board for DVI ESD protection, including schematic, layout and ESD measurements according to IEC 61000-4-2 standard. The DVI ESD Protection demonstration board provides the means to show the effectiveness of the new, ultra low capacitance DVIULC6-4SC6 device in handling the most stringent requirements of the IEC 61000-4-2 standard.

Figure 1. Top Layer

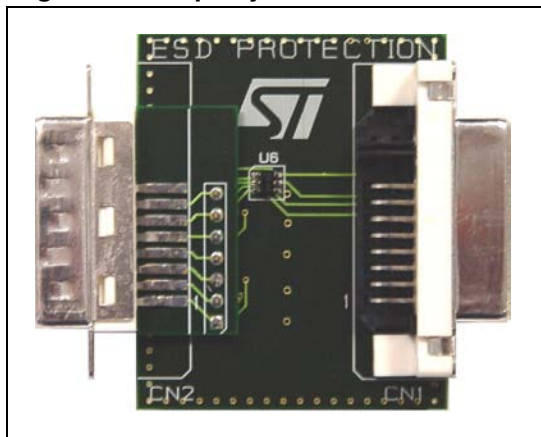
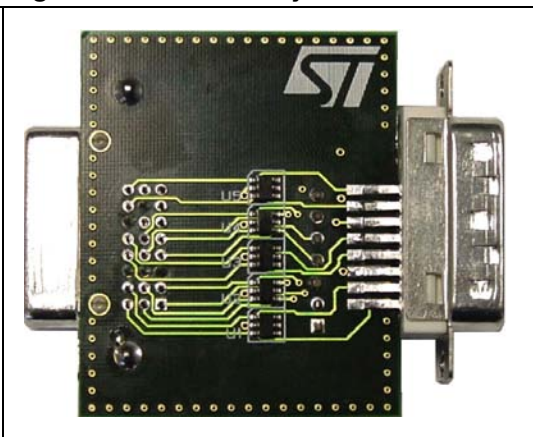

Figure 2. Bottom Layer



Contents

1	Schematics	2
2	PCB Layout	3
3	ESD Measurement	4
4	Revision history	6

1 Schematics

Figure 3. Circuit diagram

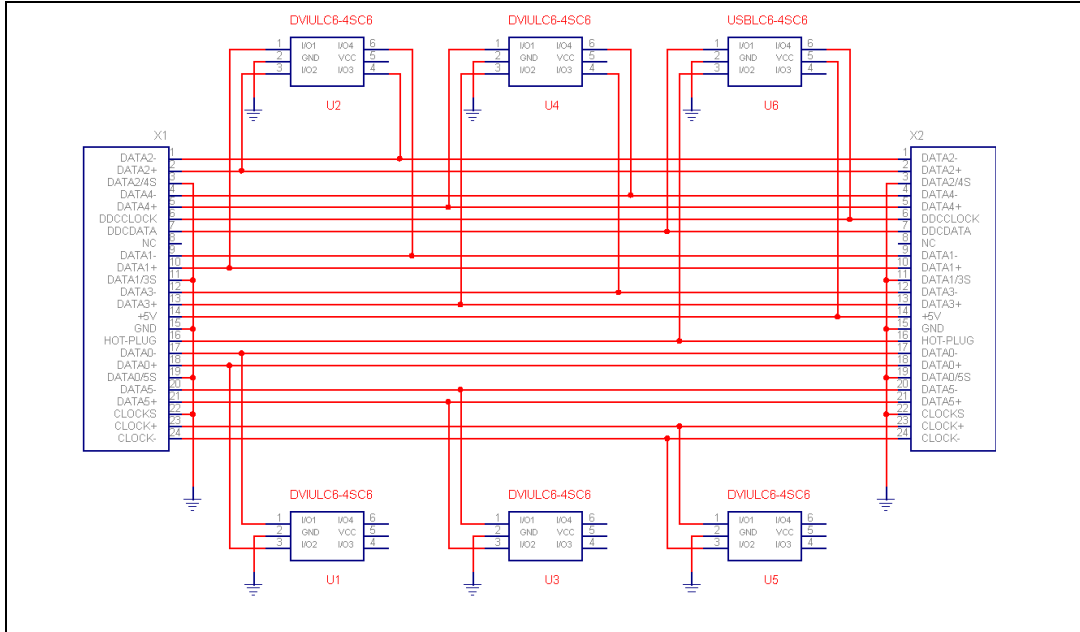
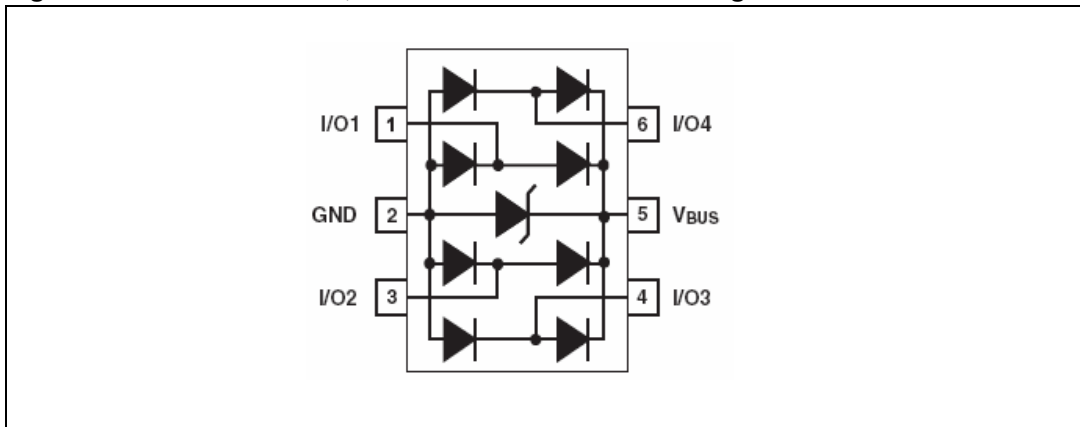

Table 1. Components

Item	Qty	Designators	P/N	Manufacturer & Part Description
1	1	X1	DV2R024N11	JAE DVI-D receptacle
2	1	X2	DV2P024M11	JAE DVI-D plug
3	5	U1, U2, U3, U4, U5	DVIULC6-4SC6	STMicroelectronics Ultra low capacitance ESD protection
4	1	U6	USBLC6-4SC6	STMicroelectronics Very low capacitance ESD protection

Figure 4. DVIULC6-4SC6, USBLC6-4SC6 Functional diagram



2 PCB Layout

Figure 5. PCB layer description

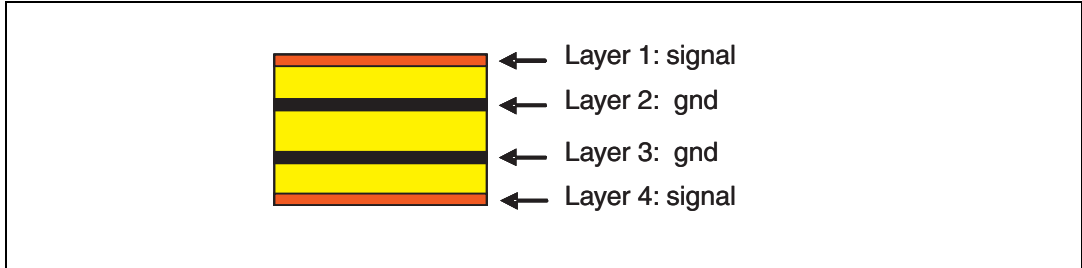

Figure 6. Top side

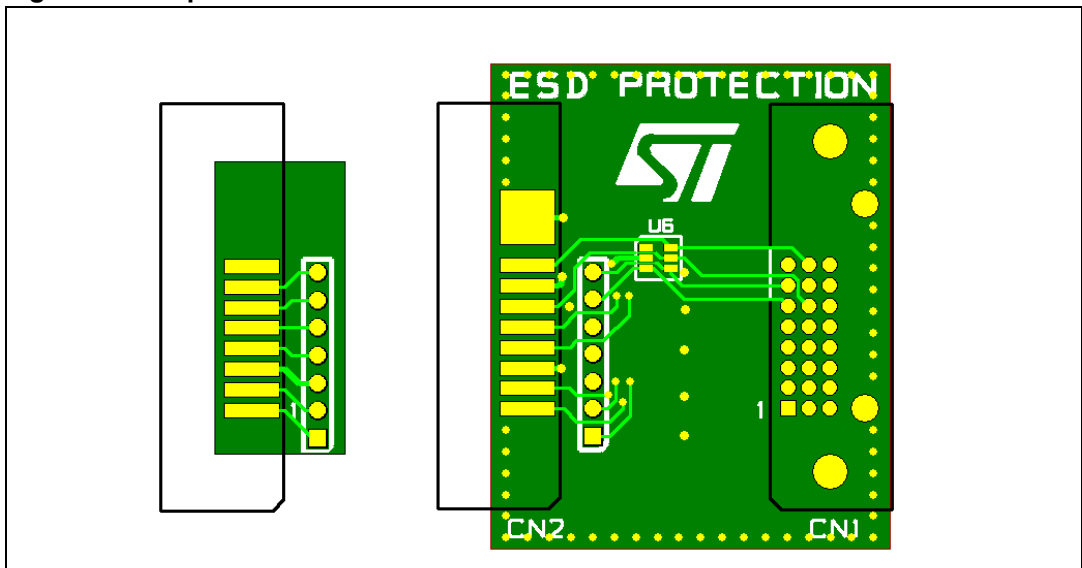
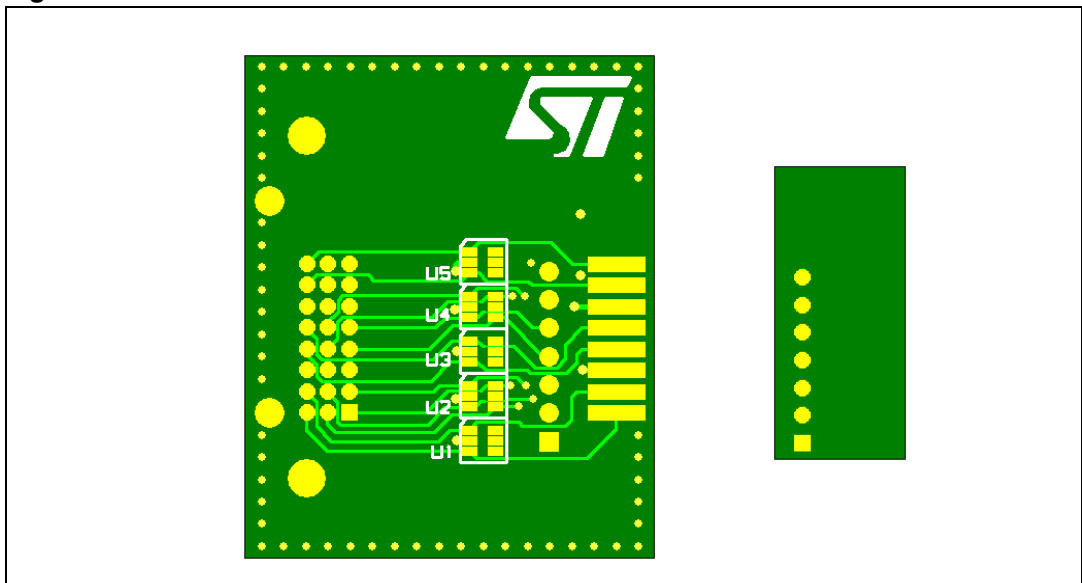
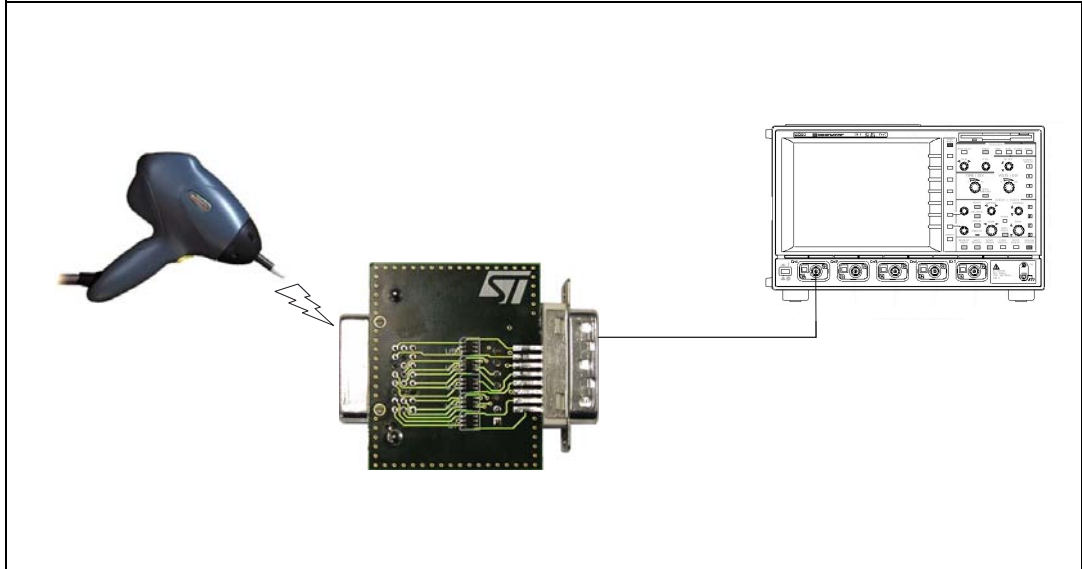

Figure 7. Bottom side



3 ESD Measurement

Figure 8. Measurement setup



- ESD Generator: Schaffner NSG 438
- Oscilloscope: Lecroy 9354
- Probe: Lecroy PP006

3.1 Measurement Results

ESD measurements have been performed according to IEC61000-4-2 level 4 air discharge standard.

Figure 9. Remaining voltage (V_{out}) after an ESD pulse of +15 kV (V_{in}) was applied to a DVIULC6-4SC6 device

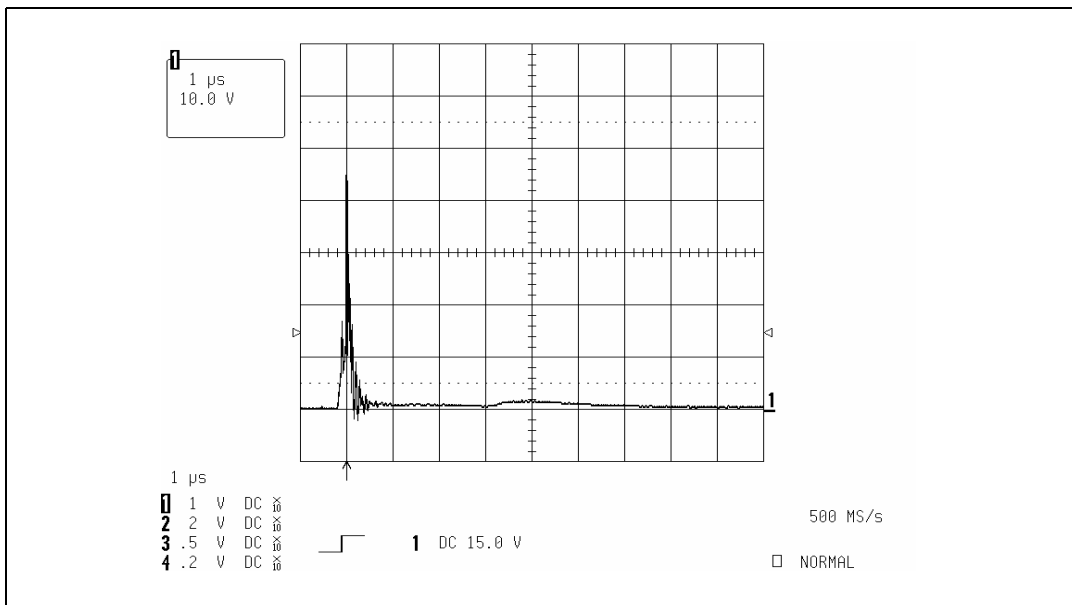
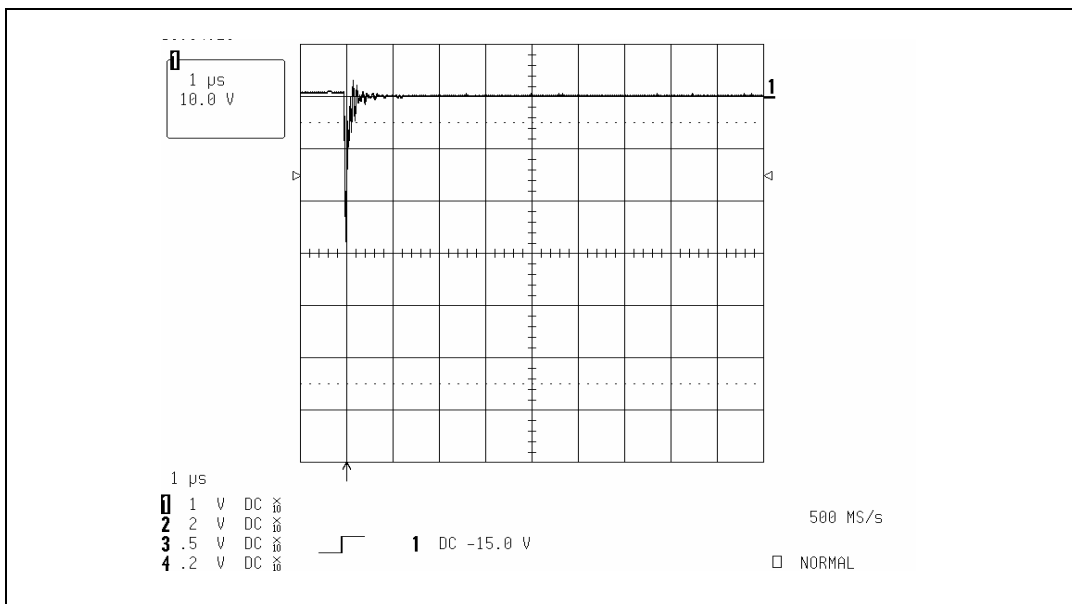

Figure 10. Remaining voltage (V_{out}) after an ESD pulse of -15 kV (V_{in}) was applied to a DVIULC6-4SC6 device



These measurements show the high level of immunity obtained using the DVIULC6-4SC6 device. The combination of ultra low capacitance and high level of ESD protection makes the DVIULC6-4SC6 device ideal for DVI applications.

4 Revision history

Date	Revision	Changes
10-Apr-2006	1	Initial release.

Please Read Carefully:

Information in this document is provided solely in connection with ST products. STMicroelectronics NV and its subsidiaries ("ST") reserve the right to make changes, corrections, modifications or improvements, to this document, and the products and services described herein at any time, without notice.

All ST products are sold pursuant to ST's terms and conditions of sale.

Purchasers are solely responsible for the choice, selection and use of the ST products and services described herein, and ST assumes no liability whatsoever relating to the choice, selection or use of the ST products and services described herein.

No license, express or implied, by estoppel or otherwise, to any intellectual property rights is granted under this document. If any part of this document refers to any third party products or services it shall not be deemed a license grant by ST for the use of such third party products or services, or any intellectual property contained therein or considered as a warranty covering the use in any manner whatsoever of such third party products or services or any intellectual property contained therein.

UNLESS OTHERWISE SET FORTH IN ST'S TERMS AND CONDITIONS OF SALE ST DISCLAIMS ANY EXPRESS OR IMPLIED WARRANTY WITH RESPECT TO THE USE AND/OR SALE OF ST PRODUCTS INCLUDING WITHOUT LIMITATION IMPLIED WARRANTIES OF MERCHANTABILITY, FITNESS FOR A PARTICULAR PURPOSE (AND THEIR EQUIVALENTS UNDER THE LAWS OF ANY JURISDICTION), OR INFRINGEMENT OF ANY PATENT, COPYRIGHT OR OTHER INTELLECTUAL PROPERTY RIGHT.

UNLESS EXPRESSLY APPROVED IN WRITING BY AN AUTHORIZE REPRESENTATIVE OF ST, ST PRODUCTS ARE NOT DESIGNED, AUTHORIZED OR WARRANTED FOR USE IN MILITARY, AIR CRAFT, SPACE, LIFE SAVING, OR LIFE SUSTAINING APPLICATIONS, NOR IN PRODUCTS OR SYSTEMS, WHERE FAILURE OR MALFUNCTION MAY RESULT IN PERSONAL INJURY, DEATH, OR SEVERE PROPERTY OR ENVIRONMENTAL DAMAGE.

Resale of ST products with provisions different from the statements and/or technical features set forth in this document shall immediately void any warranty granted by ST for the ST product or service described herein and shall not create or extend in any manner whatsoever, any liability of ST.

ST and the ST logo are trademarks or registered trademarks of ST in various countries.

Information in this document supersedes and replaces all information previously supplied.

The ST logo is a registered trademark of STMicroelectronics. All other names are the property of their respective owners.

© 2006 STMicroelectronics - All rights reserved

STMicroelectronics group of companies

Australia - Belgium - Brazil - Canada - China - Czech Republic - Finland - France - Germany - Hong Kong - India - Israel - Italy - Japan - Malaysia - Malta - Morocco - Singapore - Spain - Sweden - Switzerland - United Kingdom - United States of America

www.st.com