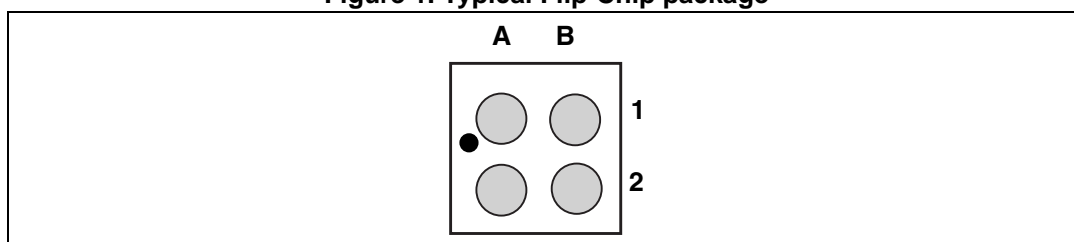

300 μm Flip Chip
package description and recommendations for use**Introduction**

This document provides package and usage recommendation information for 300 μm pitch Flip Chips assembled on board pitch 400 μm . For information on 400 μm Flip Chips, see Application note AN2348.

The competitive market of portable equipment, notably the mobile phone market, is driven by a challenging development of highly integrated products. To allow manufacturers of portable equipment to reduce the dimension of their products, STMicroelectronics has developed packages with reduced size, thickness and weight in the form of the Flip Chip. The electrical performance of such components in Flip Chips is improved thanks to shorter connections than the ones in standard plastic packages (such as TSSOP, SSOP or BGA).

Figure 1. Typical Flip-Chip package

The Flip-Chip package family has been designed to fulfill the same quality levels and the same reliability performances as standard semiconductor plastic packages. This means these new Flip-Chip packages should be considered as new surface mount devices which will be assembled on a printed circuit board (PCB) without any special or additional process steps required. In particular this package does not require any extra underfill to increase reliability performances or to protect the device. This package is compatible with existing pick and place equipment for board mounting. Only lead-free, RoHS compliant Flip Chips are available in mass production.

This application note addresses the following topics:

- Product description
- Mechanical description
- Packing specifications and labeling description
- Recommended storage and shipping instructions
- Soldering assembly recommendations
- User responsibility and returns
- Changes
- Delivery quantity
- Quality

TM: IPAD is a trademark of STMicroelectronics

1 Product description

Flip Chips are manufactured with a wafer level process that STMicroelectronics has developed by attaching solder bumps on I/O pads of the active wafer side, thus allowing bumped dice to be produced. The I/O contact layout can be either matrix shape or set in periphery. No redistribution layer is used. This allows parasitic inductances coming from the redistribution metal tracks to be minimized.

Lead-free bump composition is 96.5% Sn, 3% Ag, 0.5% Cu. This is fully compatible with standard lead-free reflow processes. The bump dimension (175 µm bump diameter) allows the pick and place process to be compatible with existing equipment (in particular with equipment used for Ball Grid Array - BGA packages) and makes it also compatible with the PCB design rules used for standard ICs.

Optional coating on the flat side of the package is available.

These components are delivered in tape and reel packing with the bumps turned down (placed on the bottom of the carrier tape cavity). The other face of the component is flat and allows picking as in the standard SMD packages.

Devices are 100% electrically tested before packing. The product references are marked on the flat side of the device.

2 Mechanical description

Mechanical dimensions of Flip Chips are provided through a product example in [Figure 2](#). Bumps are lead-free. Bump composition is 98.25% Sn, 1.2% Ag, 0.5% Cu, 0.05% Ni alloy with a near eutectic melting point of 218 to 227 °C. Die size and bump count are adapted to the connection requirements.

Figure 2. Mechanical dimensions of a 2 x 2 bump matrix array.

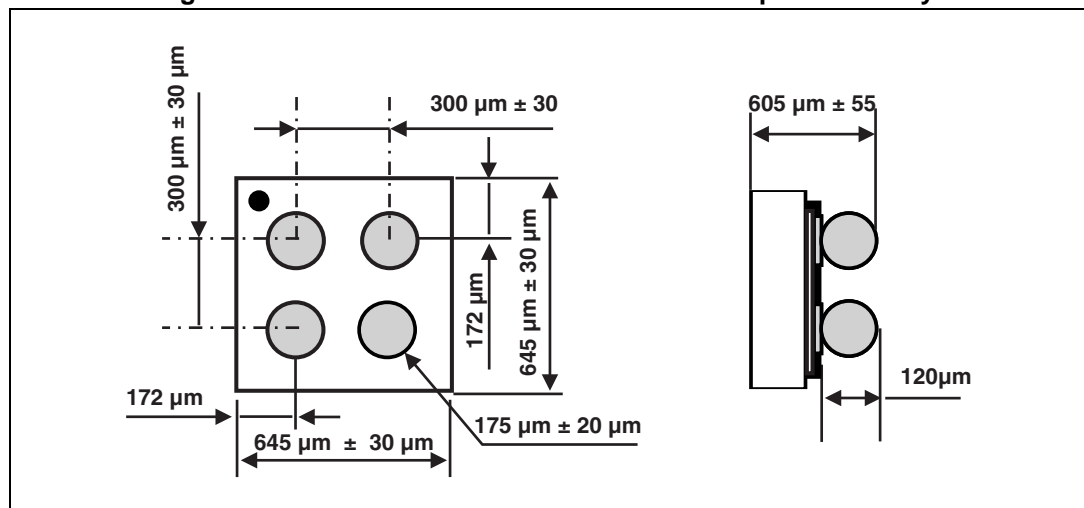

Note: The package height of 0.605 mm (0.650 mm for optionally coated packages) is valid for a die thickness of 0.48 mm.

The Flip Chip tolerance on bump diameter and bump height are very tight. This constant bump shape insures a good coplanarity between bumps. Optical measurements performed through vertical focuses show a bump plus die coplanarity below 50 μm .

The product marking for the flat side is shown on [Figure 3](#) (product example). The Flip Chip has a pin marker - A1 (see [Figure 1](#)) on both the flat side and the bump side so that the orientation of the component can be easily determined before and after assembly. The dots marked on the flat side and on the bump side have been designed so that they can be detected by standard vision systems.

Marking dimensions are linked to the die size.

Figure 3. Flip Chip marking example for 2 x 2 bump matrix array.

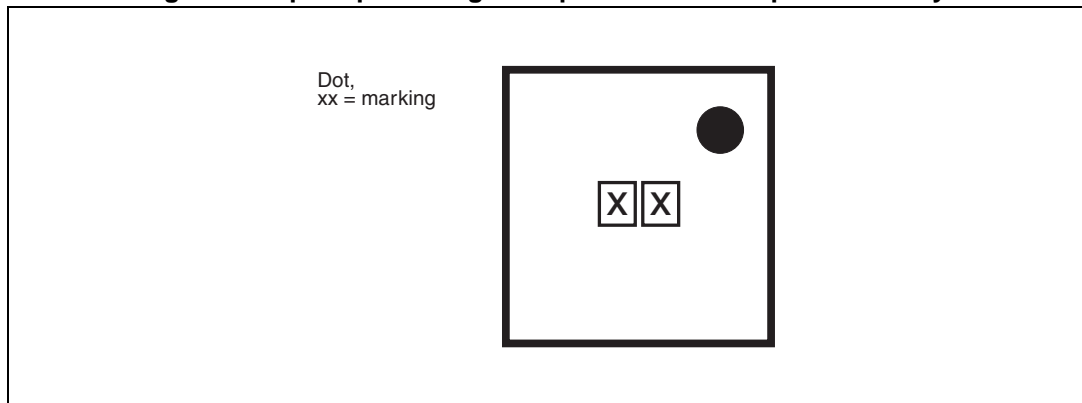

3 Packing specifications and labeling description

Flip Chips are delivered in tape and reel to be fully compatible with standard high volume SMD components. The features of tape and reel materials are in accordance with EIA-481-D, IEC 60286-3 and EIA 763 (783) standards. All features not specified in this section are in accordance with EIA-481-D, IEC 60286-3 and EIA 763 (783) standards.

3.1 Carrier tape

Flip Chips are placed in the carrier tape with their bump side facing the bottom of the cavity so that the components can be picked-up by their flat side. No flipping of the package is necessary for mounting on PCB. The products are positioned in the carrier tape with pin A1 on the sprocket hole side. Carrier tape mechanical dimensions are shown in the example in [Figure 4](#). Standard tape width is 8 mm for die sizes smaller than 3 mm (dimension B0).

Note: 12 mm carrier tape width may be used for a larger die size to be in line with EIA standards.

Figure 4. Tape dimensions for Flip Chips less than 0.8 x 0.8 mm (605 μm thickness).

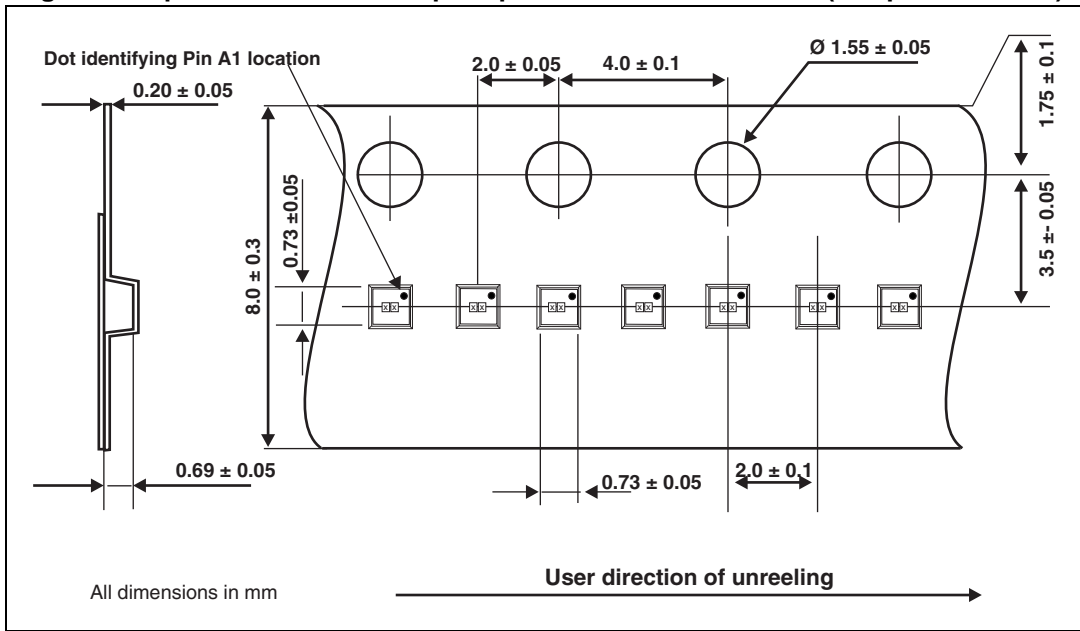

* A1 bump location varying with product layout

Table 1. Tape cavity sizing

Dimension	Die with both sides smaller than or equal to 1.5 mm	Die with one side larger than 1.5 mm
A0 and B0	Die side size + 70 μ m	Cavity dimensions established to ensure that component rotation cannot exceed 10° max.

The cavities in the carrier tape have been designed to avoid any damage to the components. Specific hole is present to improve device stability during sealing and pick up

The embossed carrier tape is in a black conductive material (surface resistivity within 10E5 and 10E11 ohm/sq). Use of this material protects the component against damage from electrostatic discharge and ensures the total discharge of the component prior to placement on the PCB. Conductivity is guaranteed to be constant and not affected by shelf life or humidity. The material will not break when bent and does not have any residue to rub off, powder, or flake.

3.2 Cover tape

The carrier tape is sealed with a transparent, anti static (surface resistivity within 10E5 ohm/sq and 10E11 ohm/sq) polyester film cover tape with a heat activated adhesive. The cover tape tensile strength is higher than 10 N.

The peeling force of the cover tape is between 0.08 N and 0.5 N in accordance with the testing method EIA-481-D and IEC 60286-3. Cover tape is peeled back in the direction opposite to the carrier tape travel; the angle between the cover tape and the carrier tape is between 165 and 180 degrees and the test is done at a speed of 120 \pm 10% mm/minute.

3.3 Reels

The sealed carrier tape with the Flip Chip is reeled on seven-inch reels (see [Figure 5](#) for reel mechanical dimensions). These reels are compliant with EIA-481-C standard. In particular, they are made of an anti static polystyrene material. Color of the reel may vary depending on supplier.

Dice quantity per reel is 5000 or 10000 or 15000 (with typical package thickness equal to 605 μm). In compliance with the IEC 60286-3, each reel contains a maximum of 0.1% empty cavities. Two successive empty cavities are not allowed. Each reel may contain components coming from 2 different wafer lots.

Each reel has a minimum leader of 400 mm and a minimum trailer of 160 mm (compliant with EIA 481-C and IEC 60286-3 standards). The leader makes up a portion of carrier tape with empty cavities and sealed by cover tape at the beginning of the reel (external side). The leader is affixed to the last turn of the carrier tape by using adhesive tape. The trailer is at the end of the reel and consists of empty, sealed cavities (see [Figure 6](#)).

Figure 5. Seven-inch reel mechanical dimensions.

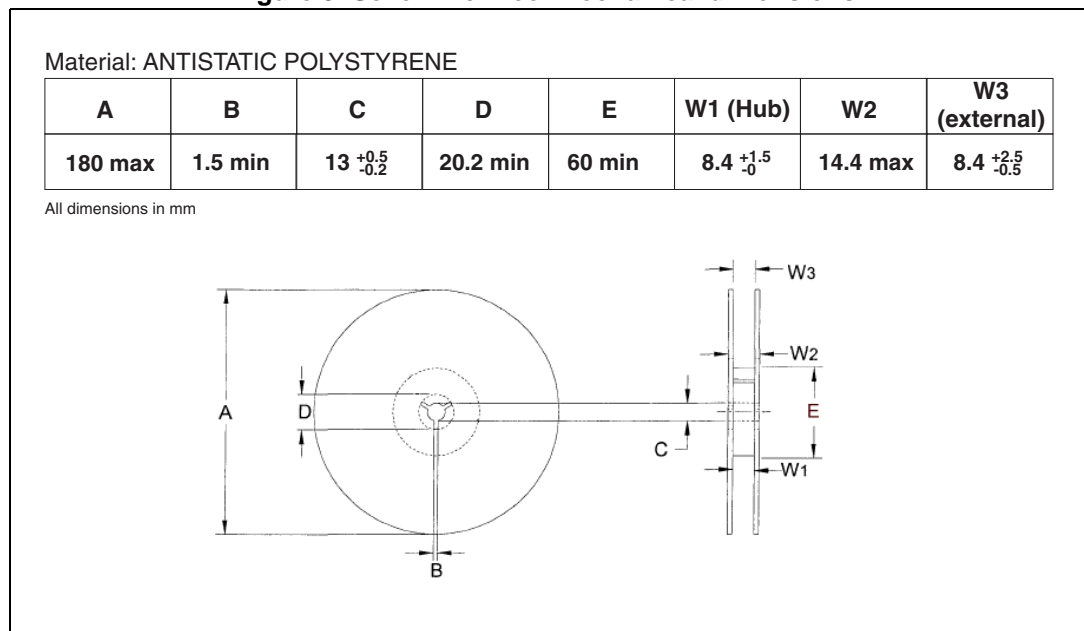
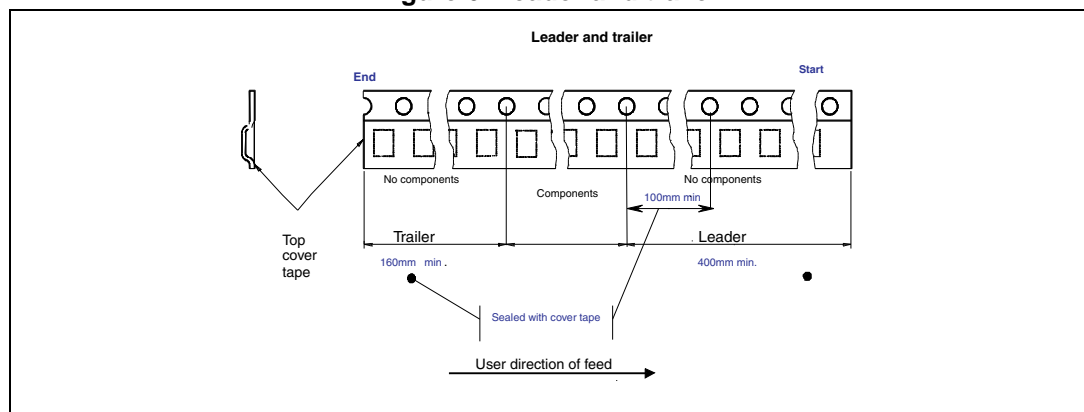

Figure 6. Leader and trailer



3.4 Final packing

Each reel is heat sealed under inert atmosphere in a transparent, recyclable and anti static polyethylene bag (minimum of 4 mils material thickness).

Reels are then packed in cardboard boxes.

The complete description for packing is shown on [Figure 7](#).

Figure 7. Packing flow chart.

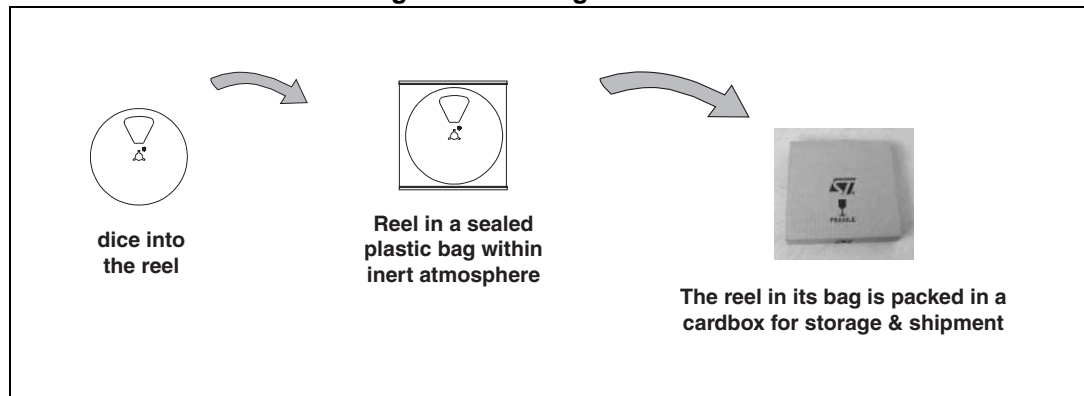

3.5 Labeling

To ensure component traceability, labels are stuck on the reels and the cardboard box. The seven inch reels and the cardboard box are identified by labels including part number, shipped quantity and traceability references ([Figure 8](#)).

The traceability is ensured for each production lot and each shipment lot through the labeling.

The trace code number printed on the labels ensures backward traceability from the lot received by the customer at each step of the process - in / out dates and quantity at diffusion, assembly, test and final store. Likewise, forward traceability is able to trace a lot history from the wafer fab to the customer's location.

Figure 8. Example of a reel label

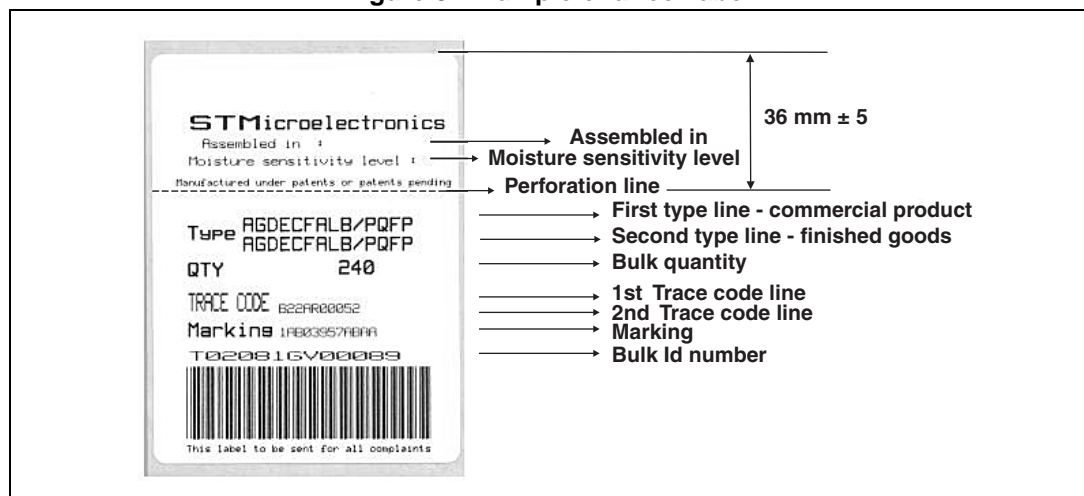

Table 2. Parameter reel label

Field	Field type
Assembled in	Mandatory: Country of origin
Pb-free 2 nd . Level interconnect	As per JEDEC Standard JESD97
MSL	Mandatory for concerned products as defined in MPI Moisture sensitivity level as per JEDEC J-STD-020 Mandatory for SMD
Bag seal date	For MSL 2 and above, date of vacuum sealing of dry bag For MSL=1, "Not Moisture Sensitive" must be printed instead
PBT	Peak package body temperature as JEDEC J-STD-020 Mandatory for the SMD
Category	Pb-free category as pr JEDEC Standard JESD97 Mandatory for concerned products as defined in MPI
Eco level	Mandatory for ECOLEVEL devices only as defined in MPI
Type	Mandatory First line: Not required Second line: Raw line product name
Total qty	Mandatory - bulk quantity
Trace code	Mandatory- Traceability code with wafer fab production area code
Bulk ID	Mandatory: Bulk ID number, start with A
Bar code	Mandatory: Bar code area

4 Recommended storage, shipping instructions and descriptions

Flip-Chip reels are packed under inert N₂ atmosphere in a sealed bag. For shipment and handling, reels are packed in a cardboard box.

STMicroelectronics thus recommends the following shipping and storage conditions:

- relative humidity between 15% and 70%
- temperature range from -55 °C to +150 °C

Components in a non opened sealed bag can be stored 6 months after shipment.

Components in tape and reel must be protected from exposure to direct sunlight.

Moisture sensitivity level (MSL as per JEDEC J-STD-020C) is not applicable to Flip-Chip devices since there is no plastic encapsulation and so no risk of moisture absorption and related possible package cracks.

5 Soldering assembly recommendations

5.1 PCB design recommendations for multi-bump Flip Chips

For optimum electrical performance and highly reliable solder joints, STMicroelectronics recommends the PCB design guidelines listed in [Table 3](#).

Table 3. PCB design recommendations.

PCB pad design	Non solder mask defined Micro via under bump allowed
PCB pad size	$\varnothing = 220 \mu\text{m}$ recommended / $260 \mu\text{m}$ maximum
Solder mask opening	$\varnothing = 300 \mu\text{m}$ minimum
PCB pad finishing	Cu - Ni (2-6 μm) - Au (0.2 μm max) or Cu OSP (Organic Substrate Protection)

Note: A too thick gold layer finishing on the PCB pad is not recommended (low joint reliability).

To optimize the natural self centering effect of Flip Chips on PCB, PCB pad positioning and size have to be properly designed (see [Figure 9](#)).

Figure 9. Multi-bump Flip-Chip bump footprint

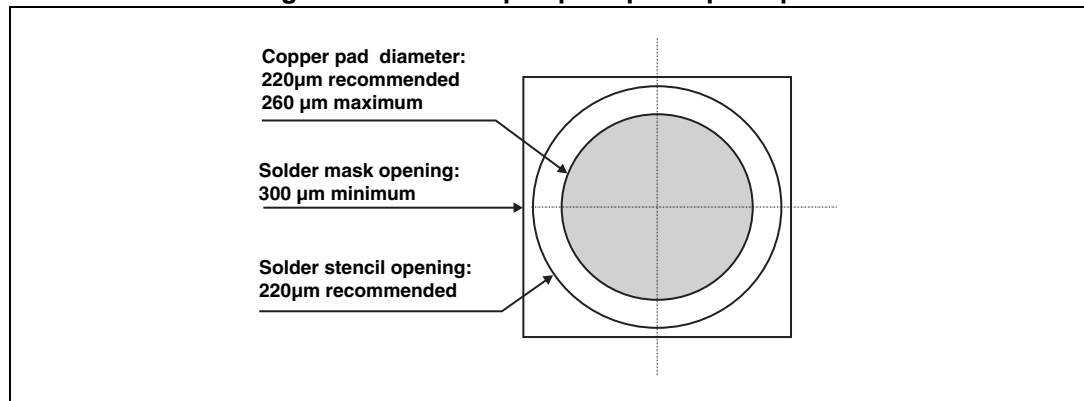

Micro vias

An alternative to routing on the top surface is to route out on buried layers. To achieve this, the pads are connected to the lower layers using micro vias.

5.2 PCB assembly guidelines

For Flip Chip mounting on the PCB, STMicroelectronics recommends the use of a solder stencil aperture of $240 \mu\text{m}$ and a typical stencil thickness of $100 \mu\text{m}$. Flip Chips are fully compatible with the use of near eutectic 95.8% Sn, 3.5% Ag, 0.7% Cu solder paste with no-clean flux. ST's recommendations for Flip-Chip board mounting are illustrated on the soldering reflow profile shown in [Figure 10](#).

Figure 10. ST ECOPACK® recommended soldering reflow profile for Flip Chip mounting on PCB (definitions)

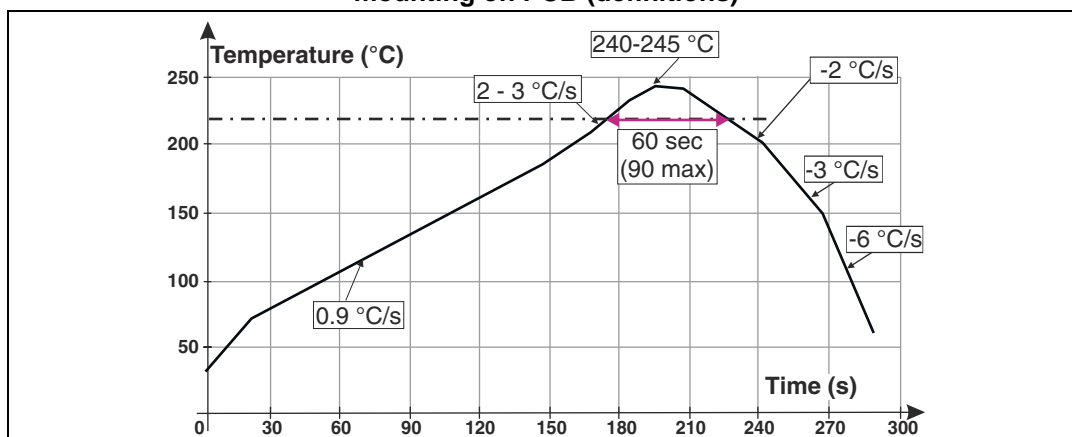

Table 4. ST ECOPACK® recommended soldering reflow profile for Flip Chip mounting on PCB (value)

Profile	Value	
	Typical	Max.
Temp. gradient in preheat (T = 70 – 180 °C)	0.9 °C/s	3 °C/s
Temp. gradient (T = 200 – 225 °C)	2 °C/s	3 °C/s
Peak temp. in reflow	240 - 245 °C	260 °C
Time above 220 °C	60 s	90 s
Temp. gradient in cooling	-2 to -3 °C/s	-6 °C/s
Time from 50 to 220 °C	160 to 220 s	

Dwell time in the soldering zone (with temperature higher than 220 °C) has to be kept as short as possible to prevent component and substrate damages. Peak temperature must not exceed 260 °C. Controlled atmosphere (N₂ or N₂H₂) is recommended during the whole reflow, specially above 150 °C.

Flip Chips are able to withstand three times the previous recommended reflow profile to be compatible with a double reflow when SMDs are mounted on both sides of the PCB plus one additional repair.

A maximum of three soldering reflows are allowed for these lead-free packages (with repair step included).

The use of a no-clean paste is highly recommended to avoid any cleaning operation. To prevent any bump cracks, ultrasonic cleaning methods are not recommended.

5.3 Underfilling

Underfilling is not essential for Flip Chips. These devices can do without an underfill if the process temperature does not exceed 175 °C and if the process time is short (typically 5 minutes).

5.4 Manual rework

Flip Chips are able to tolerate one repair in addition to the two reflows mentioned in [Section 5.2](#).

As for other BGA type packages the use of laser systems is the most suitable form for Flip Chip repair. Manual hot gas soldering is acceptable but iron soldering is not recommended.

For leaded Flip Chip manual rework the maximum temperature allowed is 260 °C (lead-free compatibility) and dwell time must not exceed 30 seconds.

For lead-free Flip Chip manual rework, the maximum temperature allowed is 260 °C. The typical soldering profile of [Figure 10](#) can be used.

5.4.1 Rework procedure

Remove the device

Rework process start with the removal of the device. To remove the device, heat must be applied to melt the solder joints so that the component can be lifted from the board.

Large area bottom side preheaters may be used to raise the temperature of the board. This may help to minimize warping of the board, and minimize the amount of heat that must be applied on the component.

Top heating may be applied to the component by using a laser or a convective hot gas nozzle. Nozzle size must be selected to match the component footprint appropriately. After top heating has melted the solder, vacuum is applied through the pick-up nozzle, and the component is lifted from the board.

The heat should be carefully directed at the component to be removed to avoid adjacent components solder joints being reflowed. Shielding, control of gas flow from the nozzle, and accurate temperature control are the key parameters.

Removing solder

Next step is cleaning the solder from the work site. Due to space constraints and the need for accurate temperature control, automatic tools are recommended.

Typically, site cleaners consist of controlled non-contact gas heating and vacuuming tools. The objective is to remove the residual solder from the site without damaging the pads, solder masks or adjacent components, and to prepare the site for application of new component.

New device soldering

For placement of the device several solutions are possible:

- Use a mini-stencil and solder paste then place the device. This is the preferred solution to ensure homogeneity of assembly conditions if assembly of WLCSP (wafer level chip scale package) is performed with solder paste, even if small footprints and tight dimensions make this operation difficult.
- Use no-clean flux on the site and place the device.
- Dip the WLCSP in no-clean flux, and to place it on the board.

Next operation is to reflow the solder joint by applying controlled heat to the component. This can be done in much the same way as described above for component removal, but accurate temperature control is necessary to ensure good soldering of the joint. Alternatively this can be done by putting the whole board in a furnace. See [Figure 10](#) for reflow profile recommendations.

Equipment

Systems for these operations are available at various levels of automation. Methods and techniques used in more sophisticated automatic systems can be copied using manual equipment. Soldering irons should be avoided for these operations. Tweezers or any picking tools pressuring the sides or bottom (bump side) of the WLCSP must be avoided since such tools can damage silicon and create chip outs.

[Figure 11](#) shows an example of semi-automatic equipment for component rework. (See the Web site of Comintec for more information.)

Figure 11. Comintec ONYX32 - Semi-automatic equipment for component rework



ONYX32 Key Features

- Fully automated X,Y,Z and theta control
- Fully automated alignment using digital feature separation (DFS) technology
- Precision force sensor and mass flow controller
- Four zone bottom preheater
- Flux dipping station
- FireWire (IEEE 1394) controls
- Visual machines software
- Machine table including power supply cabinet

ONYX32 Options

- Dispensing head for solder paste, flux, underfill or adhesives
- Non-contact temperature sensor
- Site solder removal system

6 Changes

STMicroelectronics reserves the right to implement minor changes of geometry and manufacturing processes without prior notice. Such changes will not affect electrical characteristics of the die, the pad layout or the maximum die size. However for confirmed orders, no variation will be made without customer's approval.

7 Quality

7.1 Electrical inspection

Products in Flip Chip are 100% electrically probed according to the critical parameters of the ST product specification. The last operation before packing is 100% electrical testing. The other parameters are guaranteed by technology, design rules and by continuous monitoring systems.

7.2 Visual inspection

A visual control is performed on all manufacturing lots according to the MIL-STD-883 method 2010.

8 Conclusion

Lead-free Flip-Chip packages have been developed by STMicroelectronics for electronic applications where integration and performance are the main concerns of designers.

STMicroelectronics Flip Chips offer:

- Remarkable board space saving (package size equal to die size and total height less than 605 μm)
- Enhanced electrical performance (minimized parasitic inductance due to very short electrical paths and absence of redistribution layer)
- High reliability due to integration of a whole function traditionally based on discrete interconnected components.

Flip Chips are delivered in tape and reel and are fully compatible with other high volume SMD components (standard plastic packages or CSP/BGA packages) regarding existing pick and place equipment, standard solder reflow assembly equipment and standard PCB techniques.

9 Revision history

Table 5. Document revision history

Date	Revision	Changes
05-Aug-2013	1	First issue

Please Read Carefully:

Information in this document is provided solely in connection with ST products. STMicroelectronics NV and its subsidiaries ("ST") reserve the right to make changes, corrections, modifications or improvements, to this document, and the products and services described herein at any time, without notice.

All ST products are sold pursuant to ST's terms and conditions of sale.

Purchasers are solely responsible for the choice, selection and use of the ST products and services described herein, and ST assumes no liability whatsoever relating to the choice, selection or use of the ST products and services described herein.

No license, express or implied, by estoppel or otherwise, to any intellectual property rights is granted under this document. If any part of this document refers to any third party products or services it shall not be deemed a license grant by ST for the use of such third party products or services, or any intellectual property contained therein or considered as a warranty covering the use in any manner whatsoever of such third party products or services or any intellectual property contained therein.

UNLESS OTHERWISE SET FORTH IN ST'S TERMS AND CONDITIONS OF SALE ST DISCLAIMS ANY EXPRESS OR IMPLIED WARRANTY WITH RESPECT TO THE USE AND/OR SALE OF ST PRODUCTS INCLUDING WITHOUT LIMITATION IMPLIED WARRANTIES OF MERCHANTABILITY, FITNESS FOR A PARTICULAR PURPOSE (AND THEIR EQUIVALENTS UNDER THE LAWS OF ANY JURISDICTION), OR INFRINGEMENT OF ANY PATENT, COPYRIGHT OR OTHER INTELLECTUAL PROPERTY RIGHT.

ST PRODUCTS ARE NOT AUTHORIZED FOR USE IN WEAPONS. NOR ARE ST PRODUCTS DESIGNED OR AUTHORIZED FOR USE IN: (A) SAFETY CRITICAL APPLICATIONS SUCH AS LIFE SUPPORTING, ACTIVE IMPLANTED DEVICES OR SYSTEMS WITH PRODUCT FUNCTIONAL SAFETY REQUIREMENTS; (B) AERONAUTIC APPLICATIONS; (C) AUTOMOTIVE APPLICATIONS OR ENVIRONMENTS, AND/OR (D) AEROSPACE APPLICATIONS OR ENVIRONMENTS. WHERE ST PRODUCTS ARE NOT DESIGNED FOR SUCH USE, THE PURCHASER SHALL USE PRODUCTS AT PURCHASER'S SOLE RISK, EVEN IF ST HAS BEEN INFORMED IN WRITING OF SUCH USAGE, UNLESS A PRODUCT IS EXPRESSLY DESIGNATED BY ST AS BEING INTENDED FOR "AUTOMOTIVE, AUTOMOTIVE SAFETY OR MEDICAL" INDUSTRY DOMAINS ACCORDING TO ST PRODUCT DESIGN SPECIFICATIONS. PRODUCTS FORMALLY ESCC, QML OR JAN QUALIFIED ARE DEEMED SUITABLE FOR USE IN AEROSPACE BY THE CORRESPONDING GOVERNMENTAL AGENCY.

Resale of ST products with provisions different from the statements and/or technical features set forth in this document shall immediately void any warranty granted by ST for the ST product or service described herein and shall not create or extend in any manner whatsoever, any liability of ST.

ST and the ST logo are trademarks or registered trademarks of ST in various countries.

Information in this document supersedes and replaces all information previously supplied.

The ST logo is a registered trademark of STMicroelectronics. All other names are the property of their respective owners.

© 2013 STMicroelectronics - All rights reserved

STMicroelectronics group of companies

Australia - Belgium - Brazil - Canada - China - Czech Republic - Finland - France - Germany - Hong Kong - India - Israel - Italy - Japan - Malaysia - Malta - Morocco - Philippines - Singapore - Spain - Sweden - Switzerland - United Kingdom - United States of America

www.st.com