

**Automatic Antenna Tuning (AAT)
of ST25R3911B/ST25R391x devices****Introduction**

The antenna parameters of an NFC reader such as antenna inductance and self resonance frequency can change depending on environmental influences. Such influences could be caused by mounting the reader PCB in its final housing or placing the complete reader unit close to a metal object during operation.

Changing the antenna parameters results in detuning of the antenna and the performance is decreased. Depending on the initial antenna matching components, overshoots during and after modulation can occur. It is also possible that the detuning of the antenna causes a decreased matching impedance, which can result in violation of the maximum power consumption of the reader device.

To overcome these effects, retuning of the matching network can be performed by using the Automatic Antenna Tuning (AAT) feature of the ST25R3911B device.

This application note describes both the software- and the hardware-based AAT using the ST25R3911B-DISCO board as an example platform.

The software-based AAT algorithm is an example of how to tune the antenna for either a target phase or amplitude. This option can be seen as an alternative to the hardware-based AAT, where the amplitude is always maximized.

Along this document only the device ST25R3911B is mentioned, but the content of this application note applies to ST25R3911, ST25R3913 and ST25R3914 devices also. An implementation of the mentioned algorithms is done in the STSW-ST25R001 software.

Table 1. Applicable devices

Type	Part numbers
ST25 NFC / RFID Tags and Readers	ST25R3911B ST25R3911 ST25R3913 ST25R3914
Software	STSW-ST25R001

Contents

- 1 Automatic Antenna Tuning principle 5**

- 2 Target impedance measurements and current consumption 7**
 - 2.1 Trim value 0 7
 - 2.2 Trim value 1 8
 - 2.3 Trim value 2 9
 - 2.4 Trim value 3 10
 - 2.5 Trim value 4 11
 - 2.6 Trim value 5 12
 - 2.7 Trim value 6 13
 - 2.8 Trim value 7 14
 - 2.9 Trim value 8 15
 - 2.10 Trim value 9 16
 - 2.11 Trim value 10 17
 - 2.12 Trim value 11 18
 - 2.13 Trim value 12 19
 - 2.14 Trim value 13 20
 - 2.15 Trim value 14 21
 - 2.16 Trim value 15 22

- 3 GUI 23**

- 4 Conclusion 26**

- 5 Revision history 27**

List of tables

Table 1.	Applicable devices	1
Table 2.	AAT algorithms selectable options	23
Table 3.	Document revision history	27

List of figures

Figure 1.	Antenna matching circuit with Automatic Antenna Tuning	6
Figure 2.	Trim value 0 impedance measurement	7
Figure 3.	Trim value 1 impedance measurement	8
Figure 4.	Trim value 2 impedance measurement	9
Figure 5.	Trim value 3 impedance measurement	10
Figure 6.	Trim value 4 impedance measurement	11
Figure 7.	Trim value 5 impedance measurement	12
Figure 8.	Trim value 6 impedance measurement	13
Figure 9.	Trim value 7 impedance measurement	14
Figure 10.	Trim value 8 impedance measurement	15
Figure 11.	Trim value 9 impedance measurement	16
Figure 12.	Trim value 10 impedance measurement	17
Figure 13.	Trim value 11 impedance measurement	18
Figure 14.	Trim value 12 impedance measurement	19
Figure 15.	Trim value 13 impedance measurement	20
Figure 16.	Trim value 14 impedance measurement	21
Figure 17.	Trim value 15 impedance measurement	22
Figure 18.	Antenna Feature, HW based AAT	23
Figure 19.	Antenna Feature, SW based, optimized for phase AAT	24
Figure 20.	Antenna Feature, SW based, optimized for amplitude AAT	25

1 Automatic Antenna Tuning principle

There are several factors which necessitate antenna retuning after production or between communication attempts. The most common reasons for a detuned antenna are:

- Variation of the matching components
- Manufacturing variations of the PCB or wire-wound antenna
- Temperature behavior of the antenna material or material close to the antenna (ferrite)
- Detuning due to environmental effects (mounting of the reader unit close to metal)
- Application dependent switching between two matching options (low-power matching and high-power matching)

An easy way to compensate the above mentioned effects is to change the value of the parallel capacitor therefore hence adjusting the frequency of resonance of the LC antenna tank.

Automatic Antenna Tuning is a feature of the ST25R3911B device that switches eight binary-weighted capacitors (four for each RFO channel) in parallel to the parallel capacitor. Using this method the parallel capacitor can be adjusted in 16 steps depending on the trim range given by the capacitor values.

Figure 1 shows a typical AAT configuration, which is also used on the ST25R3911B-DISCO board.

Figure 1. Antenna matching circuit with Automatic Antenna Tuning

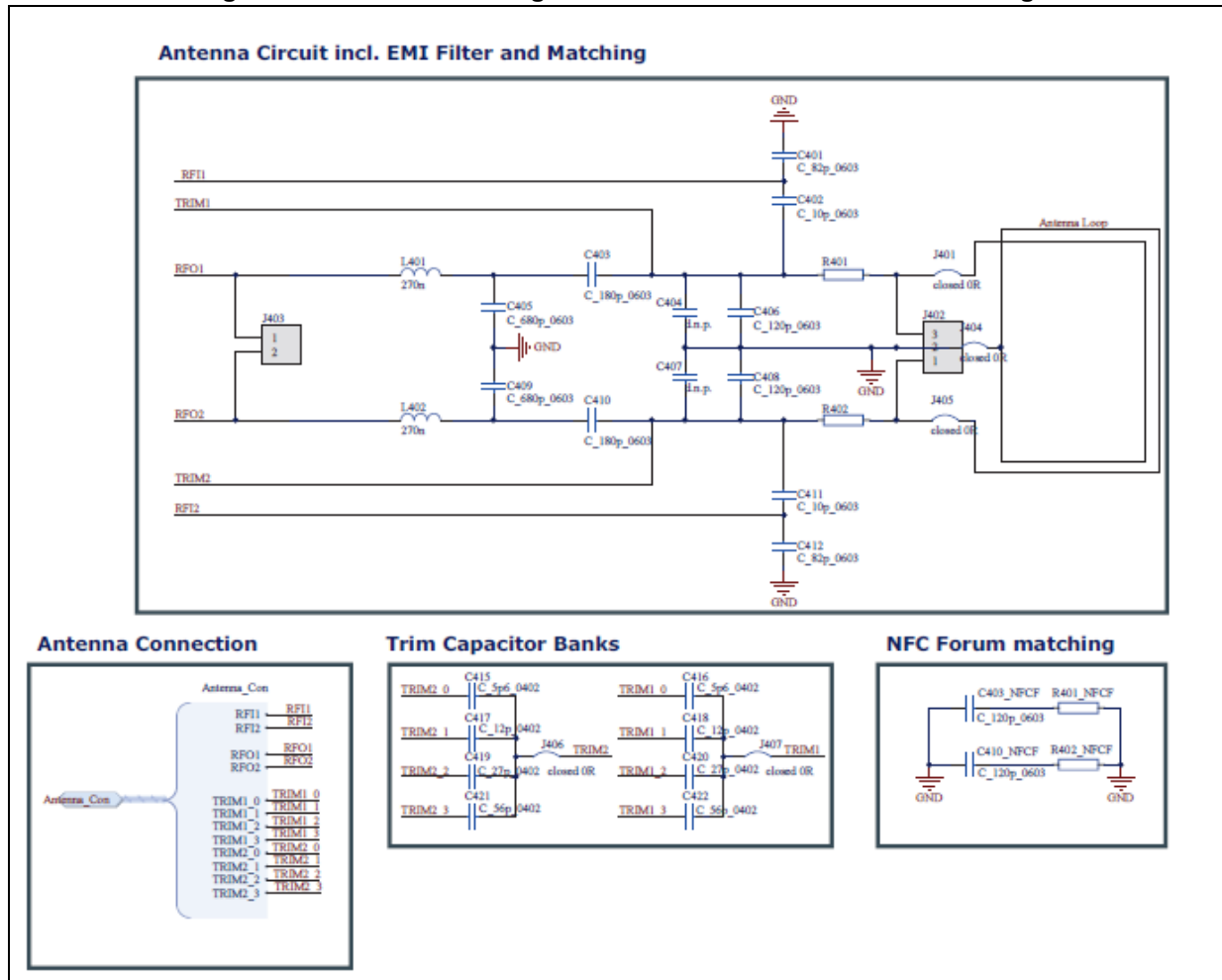

The LSB trim capacitor should not be lower than 5.6 pF. As a rule of thumb, the trim range (sum of all trim capacitors) should be in the range of between 1/4 and 3/4 of the parallel capacitor value.

To adapt the schematic for the use of AAT, it is recommended to design the reader using the Antenna Matching Tool. Depending on the self-resonance frequency of the unmatched antenna, more or less parallel capacitance is needed to tune the frequency of resonance to 13.56 MHz. A good approach is to reduce the calculated parallel capacitor by the MSB trim capacitor value.

For example, if the calculate value of parallel capacitor is 180 pF and the MSB trim capacitor is 56 pF, the new parallel capacitor could then be chosen as 120 pF value. This would result in a trim value of 8.

2 Target impedance measurements and current consumption

On the ST25R3911B-DISCO, there are 16 different target impedances, with the associated current consumption at VSP_RF = 4.62 V, corresponding to the 16 trim values.

2.1 Trim value 0

Figure 2. Trim value 0 impedance measurement

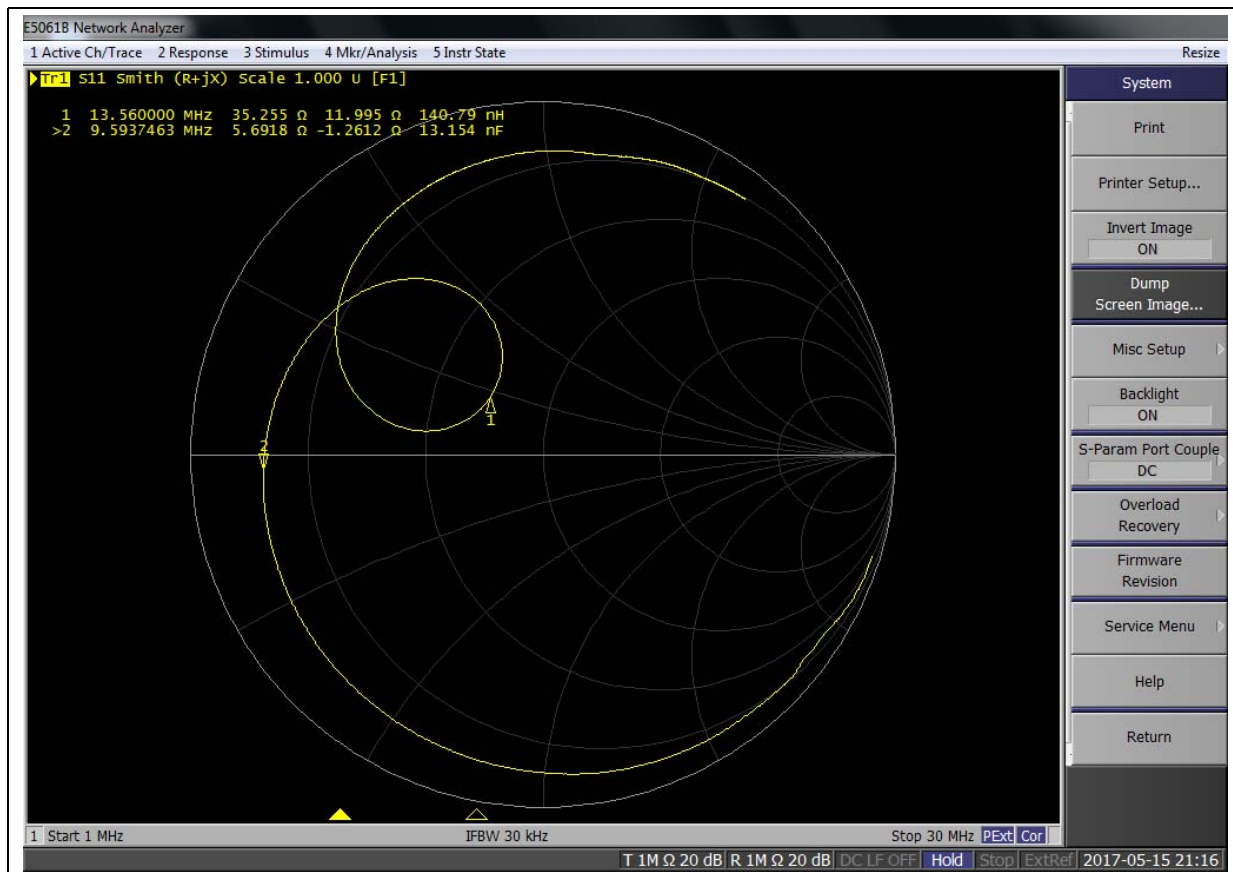

Conditions:

- $Z = 35.3 \Omega + j12 \Omega$ at 13,56 MHz; $|Z| = 37.24 \Omega$
- Current consumption: 88.3 mA

2.2 Trim value 1

Figure 3. Trim value 1 impedance measurement

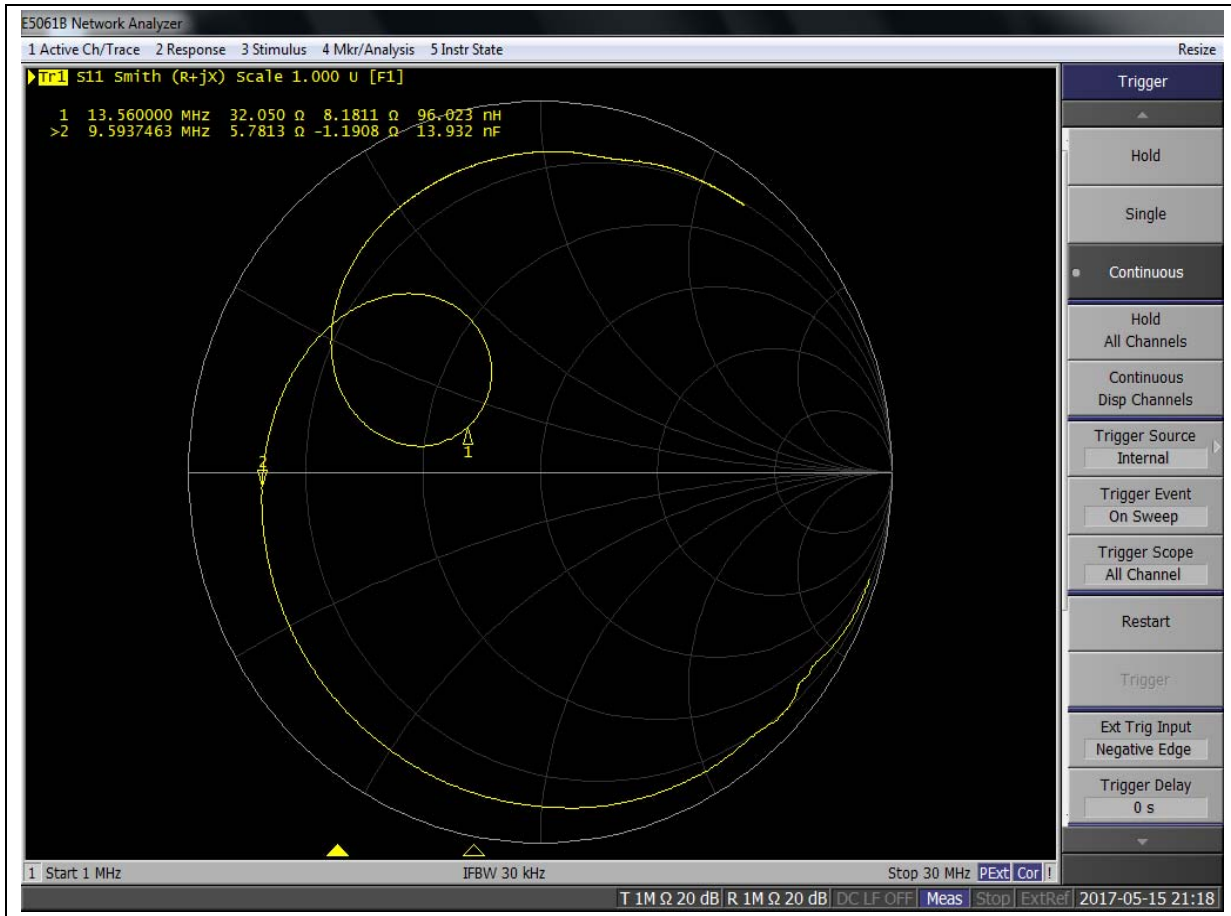

Conditions:

- $Z = 32.05 \Omega + j8.181 \Omega$ at 13,56 MHz; $|Z| = 33.1 \Omega$
- Current consumption: 93.2 mA

2.3 Trim value 2

Figure 4. Trim value 2 impedance measurement

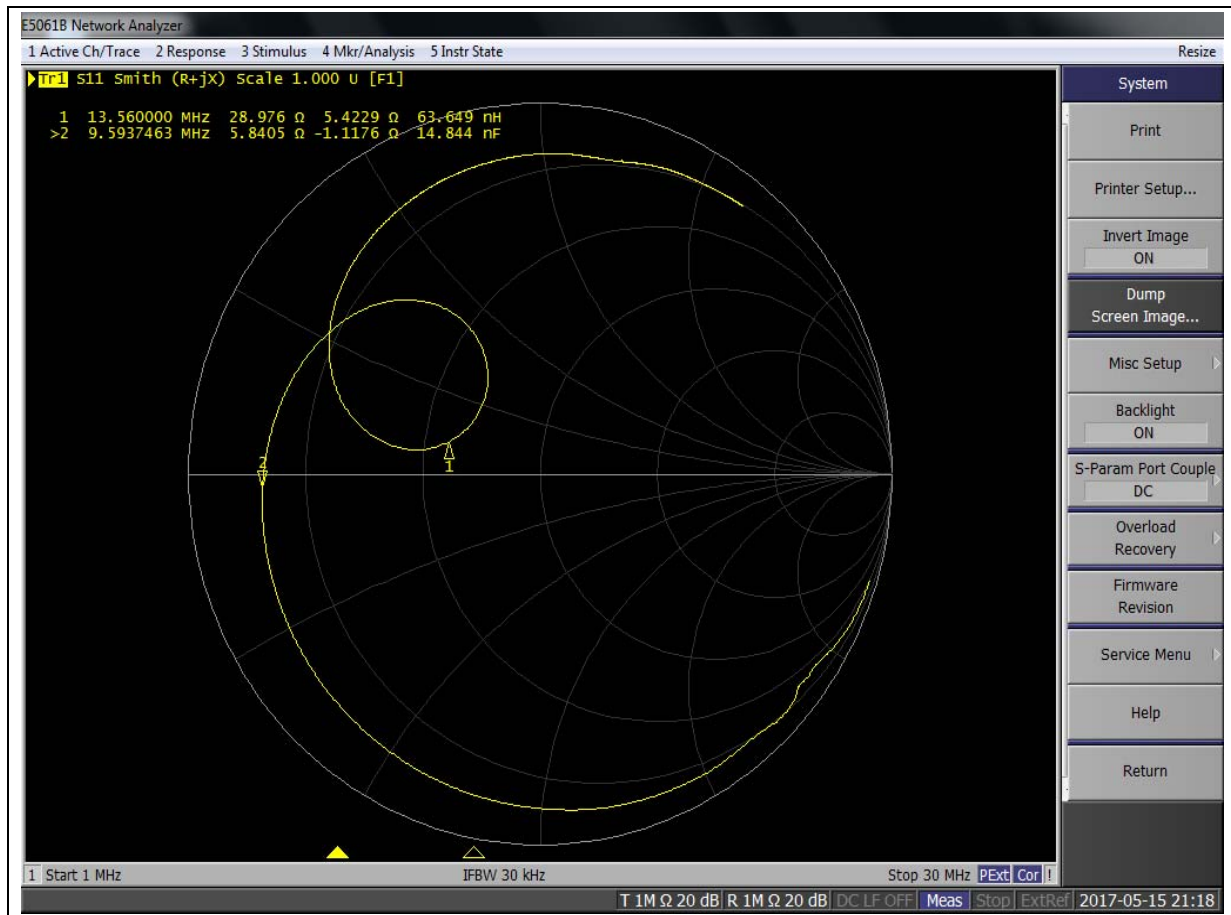

Conditions:

- $Z = 29 \Omega + j5.4 \Omega$ at 13,56 MHz; $|Z| = 29.5 \Omega$
- Current consumption: 102.8 mA

2.4 Trim value 3

Figure 5. Trim value 3 impedance measurement

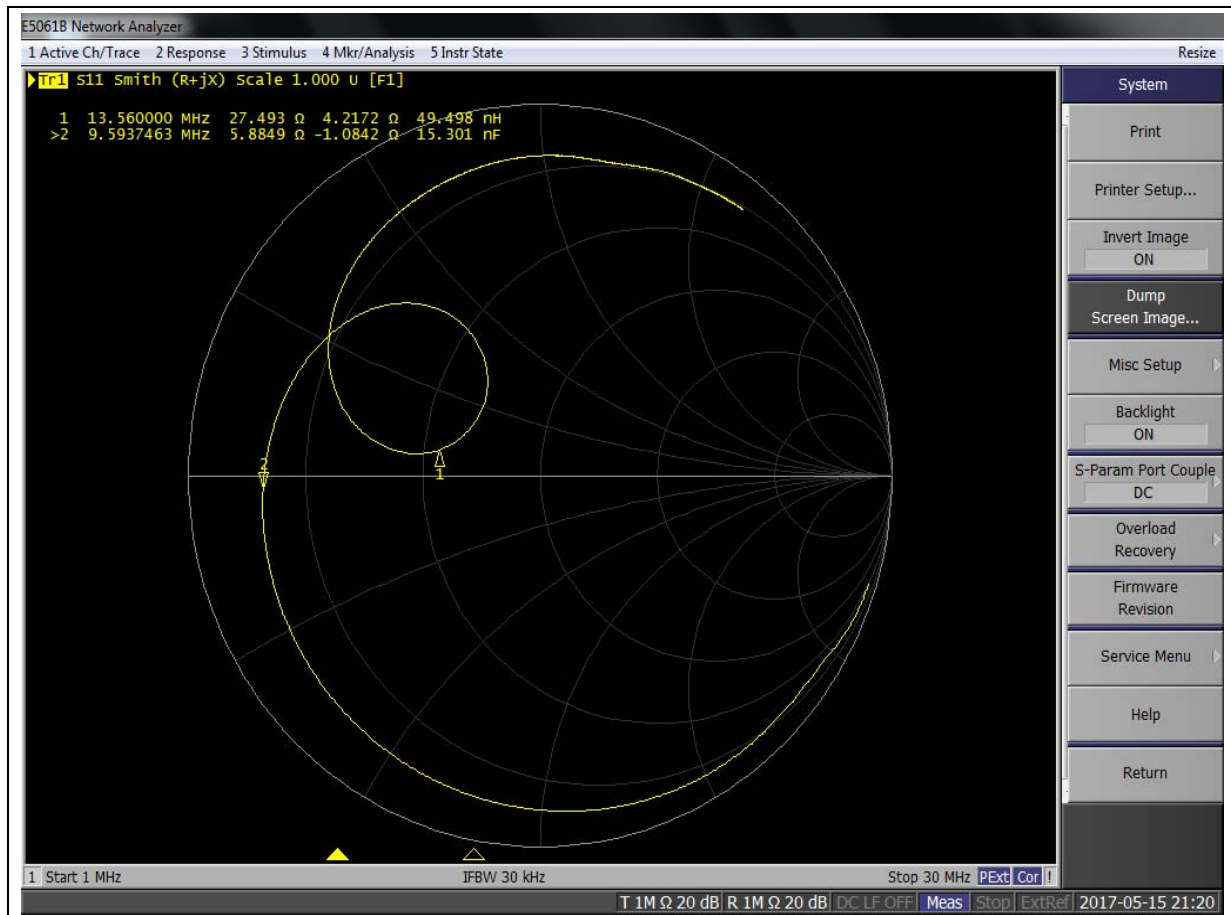

Conditions:

- $Z = 27.5 \Omega + j4.2 \Omega$ at 13,56 MHz; $|Z| = 27.8 \Omega$
- Current consumption: 109.4 mA

2.5 Trim value 4

Figure 6. Trim value 4 impedance measurement

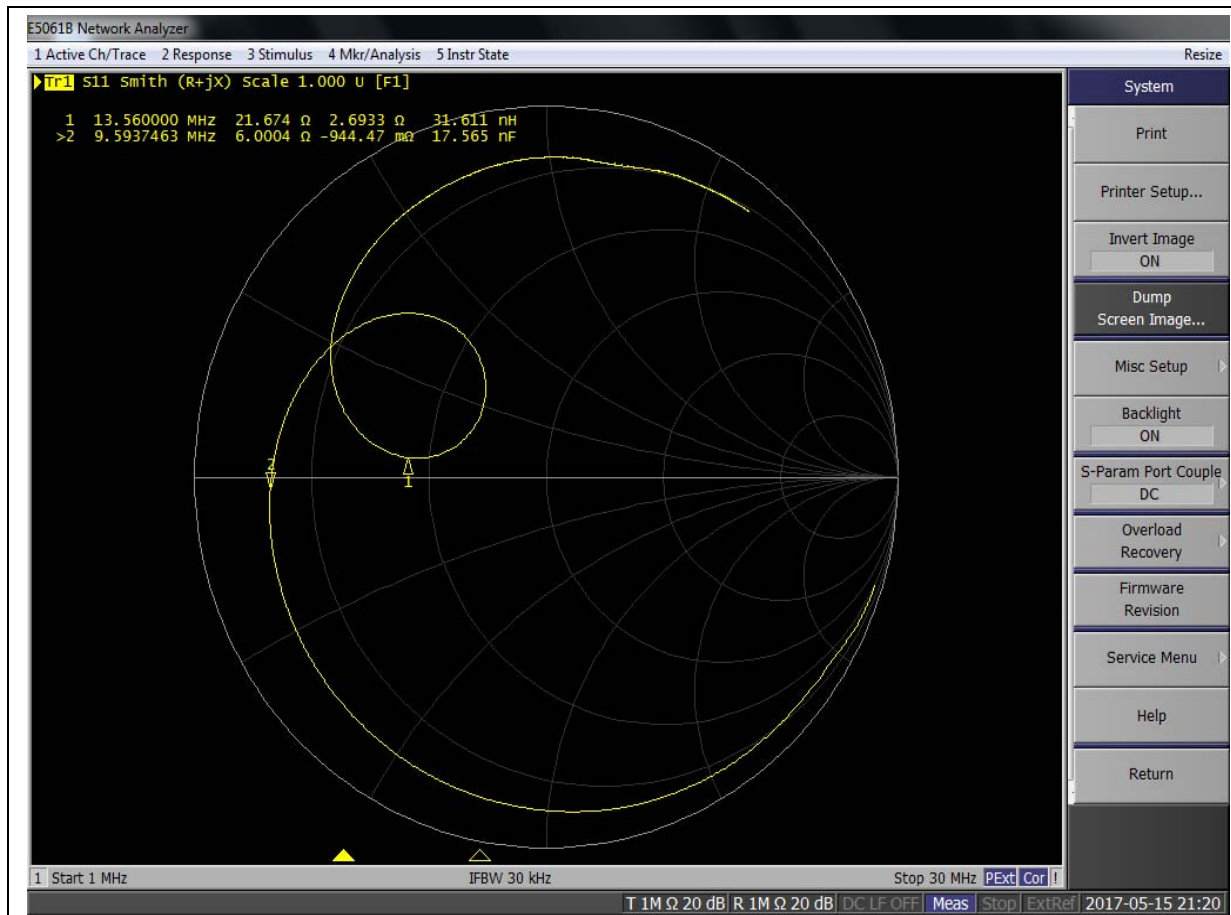

Conditions:

- $Z = 21.7 \Omega + j2.7 \Omega$ at 13,56 MHz; $|Z| = 21.84 \Omega$
- Current consumption: 149.2 mA

2.6 Trim value 5

Figure 7. Trim value 5 impedance measurement

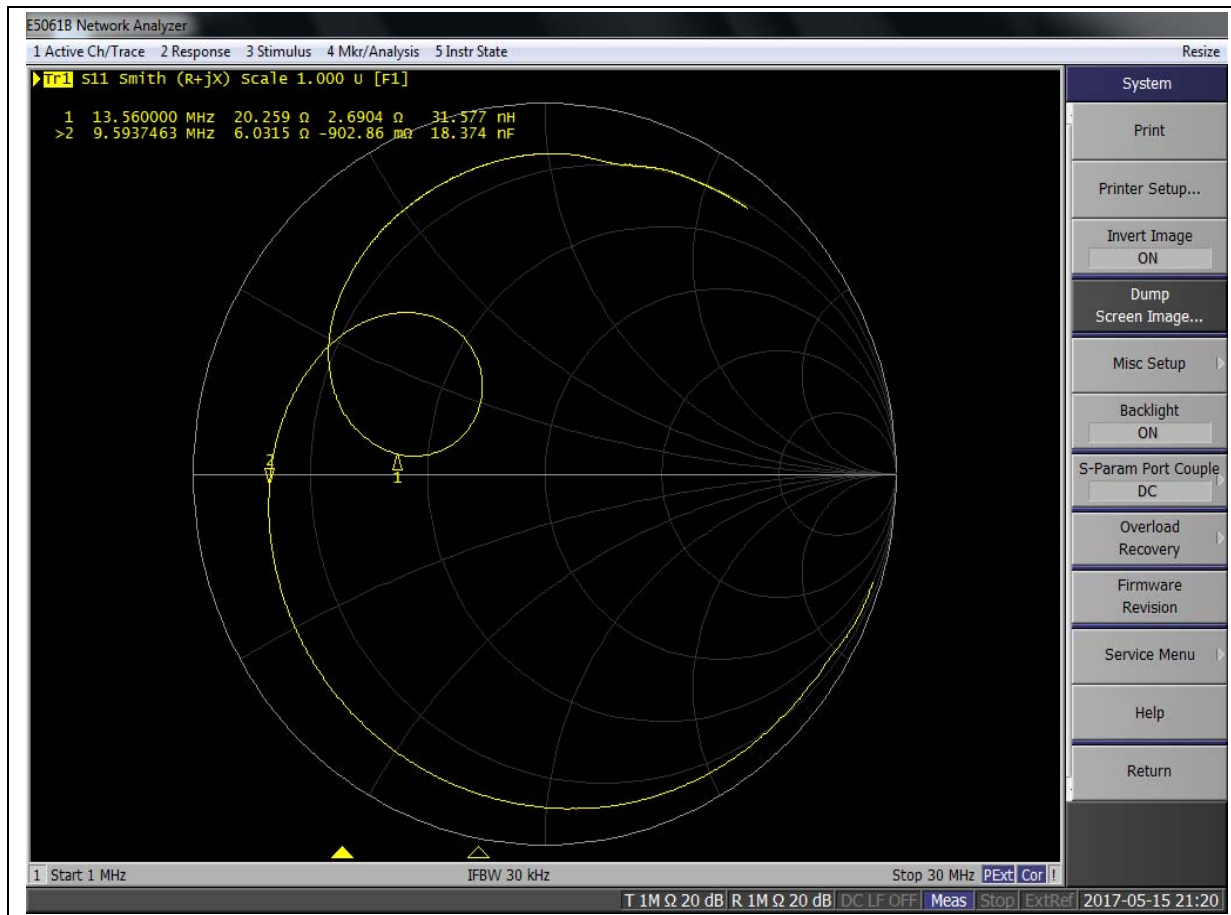

Conditions:

- $Z = 20.3 \Omega + j2.7 \Omega$ at 13,56 MHz; $|Z| = 20.43 \Omega$
- Current consumption: 159.4 mA

2.7 Trim value 6

Figure 8. Trim value 6 impedance measurement

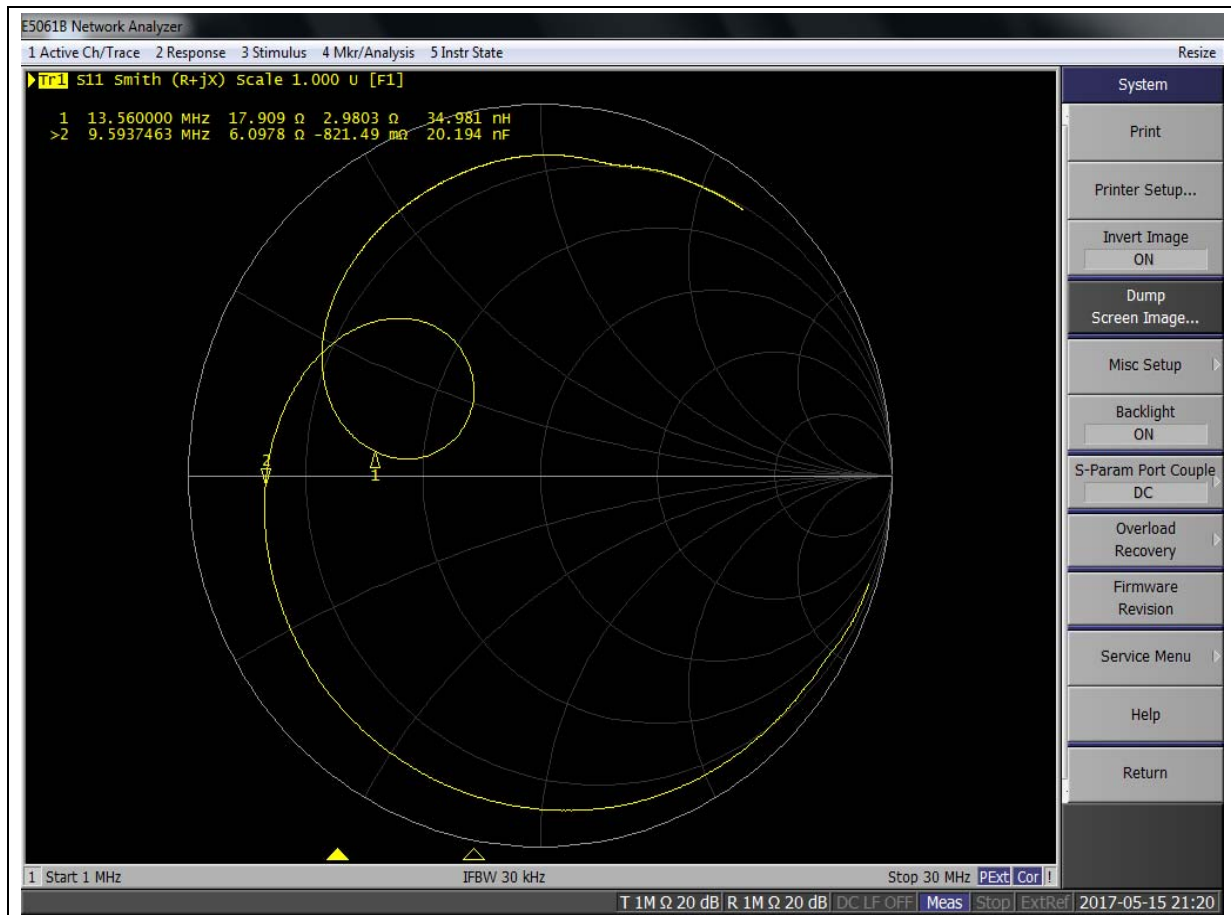

Conditions:

- $Z = 17.9 \Omega + j3 \Omega$ at 13,56 MHz; $|Z| = 18.2 \Omega$
- Current consumption: 176.3 mA

2.8 Trim value 7

Figure 9. Trim value 7 impedance measurement

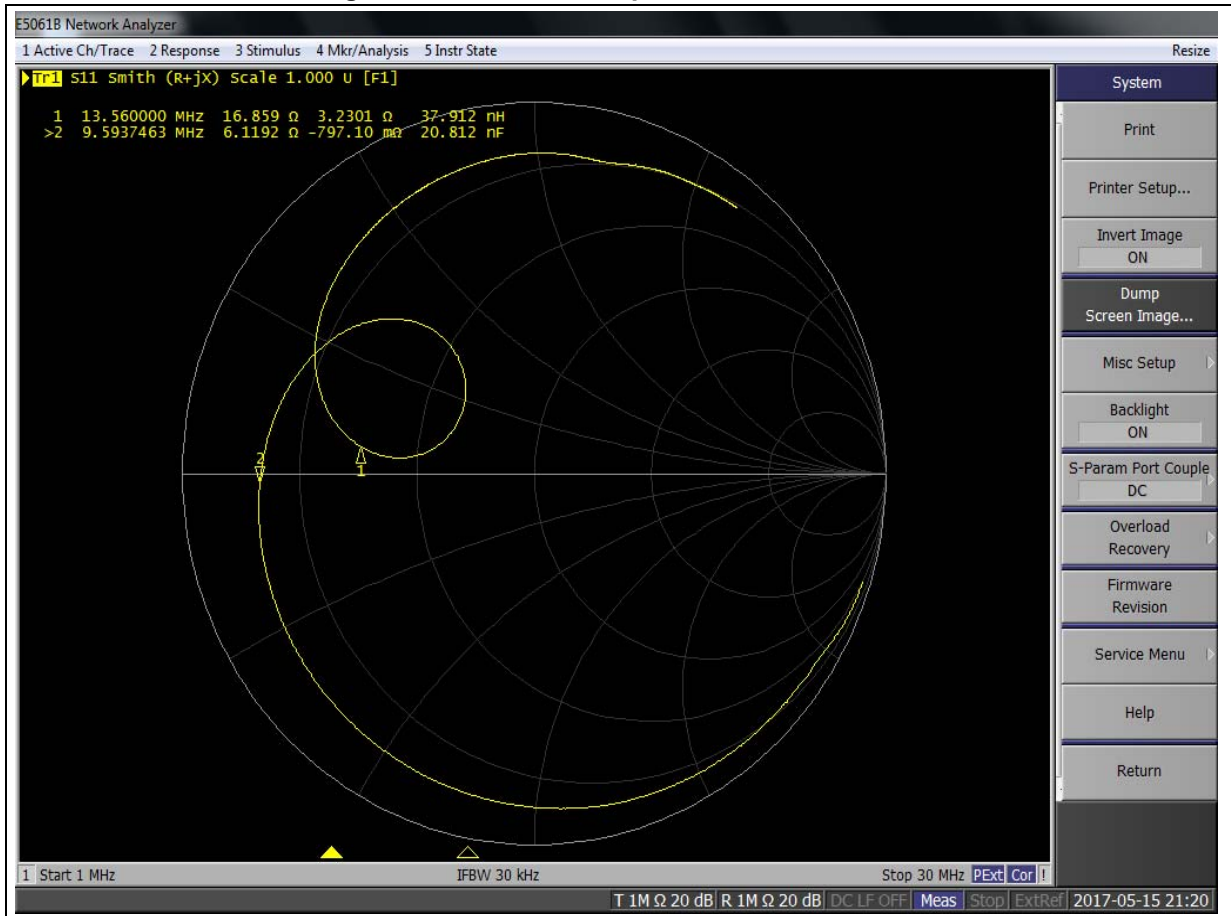

Conditions:

- $Z = 16.9 \Omega + j3.2 \Omega$ at 13,56 MHz; $|Z| = 16.9 \Omega$
- Current consumption: 186.1 mA

2.9 Trim value 8

Figure 10. Trim value 8 impedance measurement

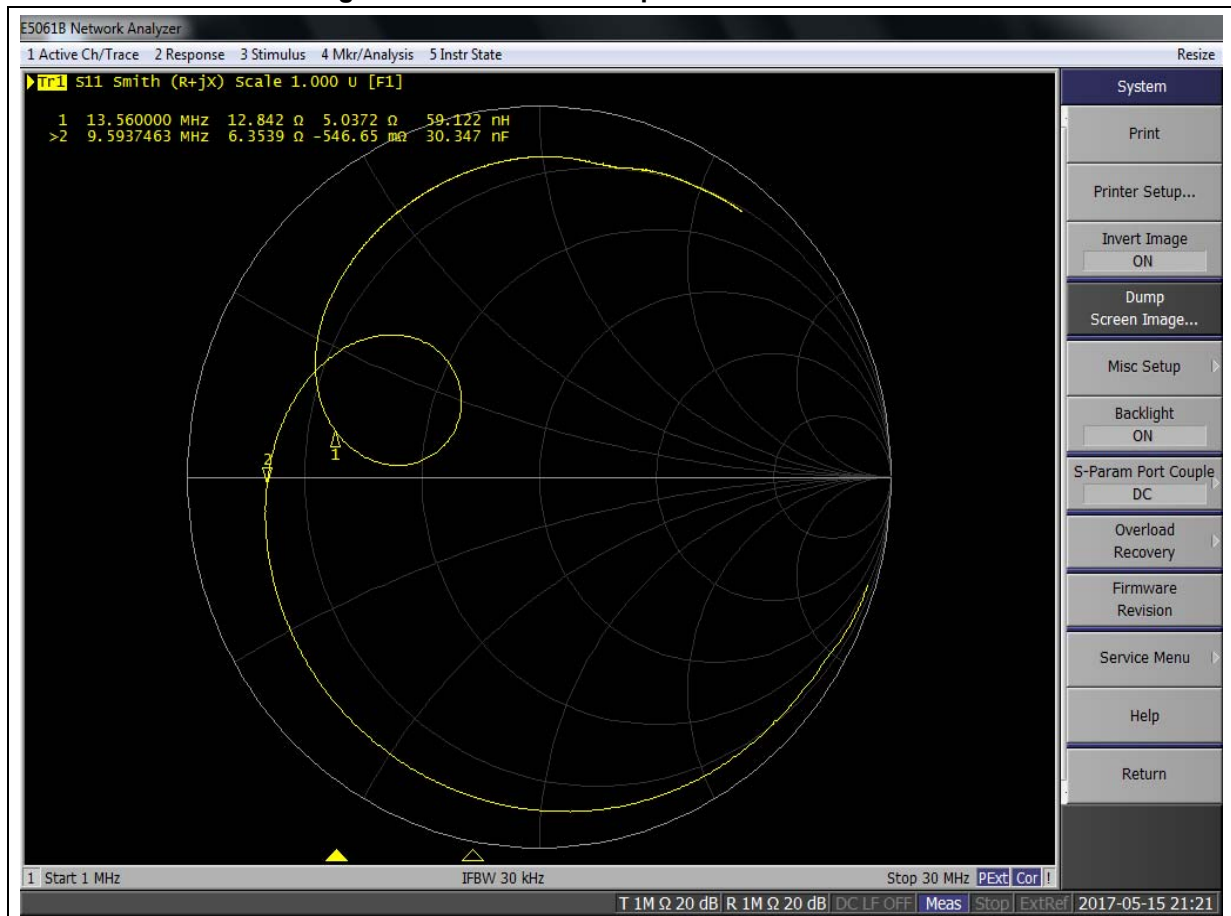

Conditions: $Z = 12.8 \Omega + j5 \Omega$ at 13,56 MHz; $|Z| = 13.8 \Omega$

- Current consumption: 213.4 mA

2.10 Trim value 9

Figure 11. Trim value 9 impedance measurement

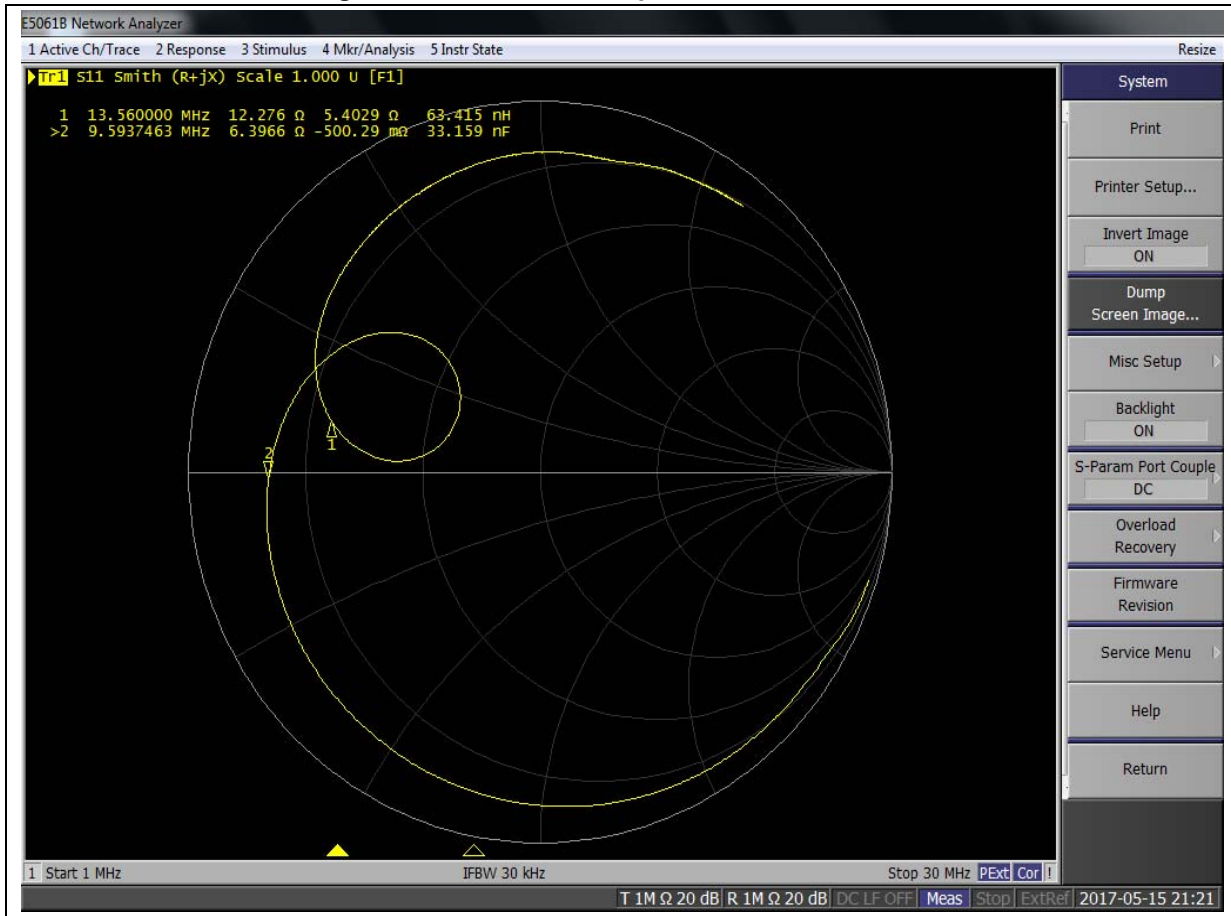

Conditions:

- $Z = 12.3 \Omega + j5.4 \Omega$ at 13,56 MHz; $|Z| = 13.4 \Omega$
- Current consumption: 216.8 mA

2.11 Trim value 10

Figure 12. Trim value 10 impedance measurement

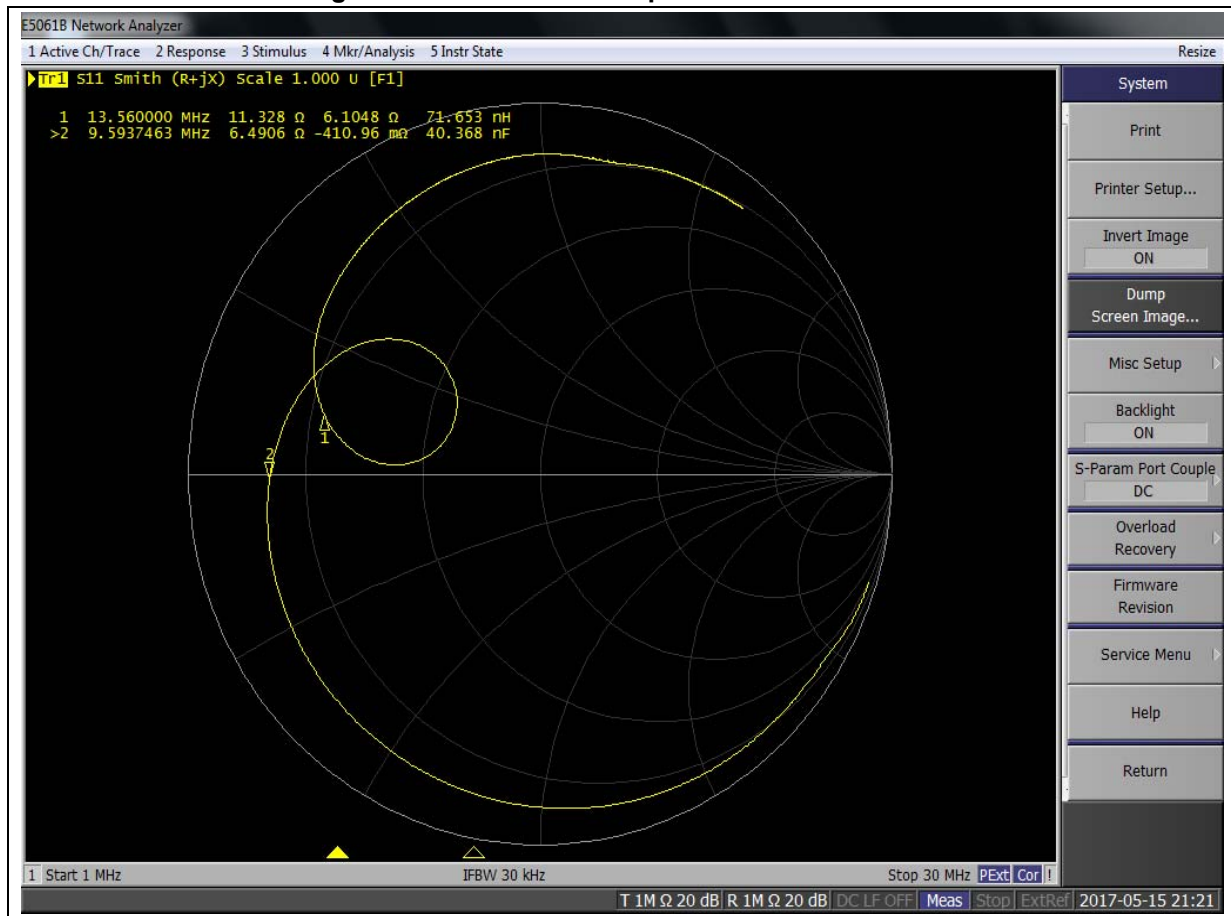

Conditions:

- $Z = 11.3 \Omega + j6.1 \Omega$ at 13,56 MHz; $|Z| = 12.9 \Omega$
- Current consumption: 220.3 mA

2.12 Trim value 11

Figure 13. Trim value 11 impedance measurement

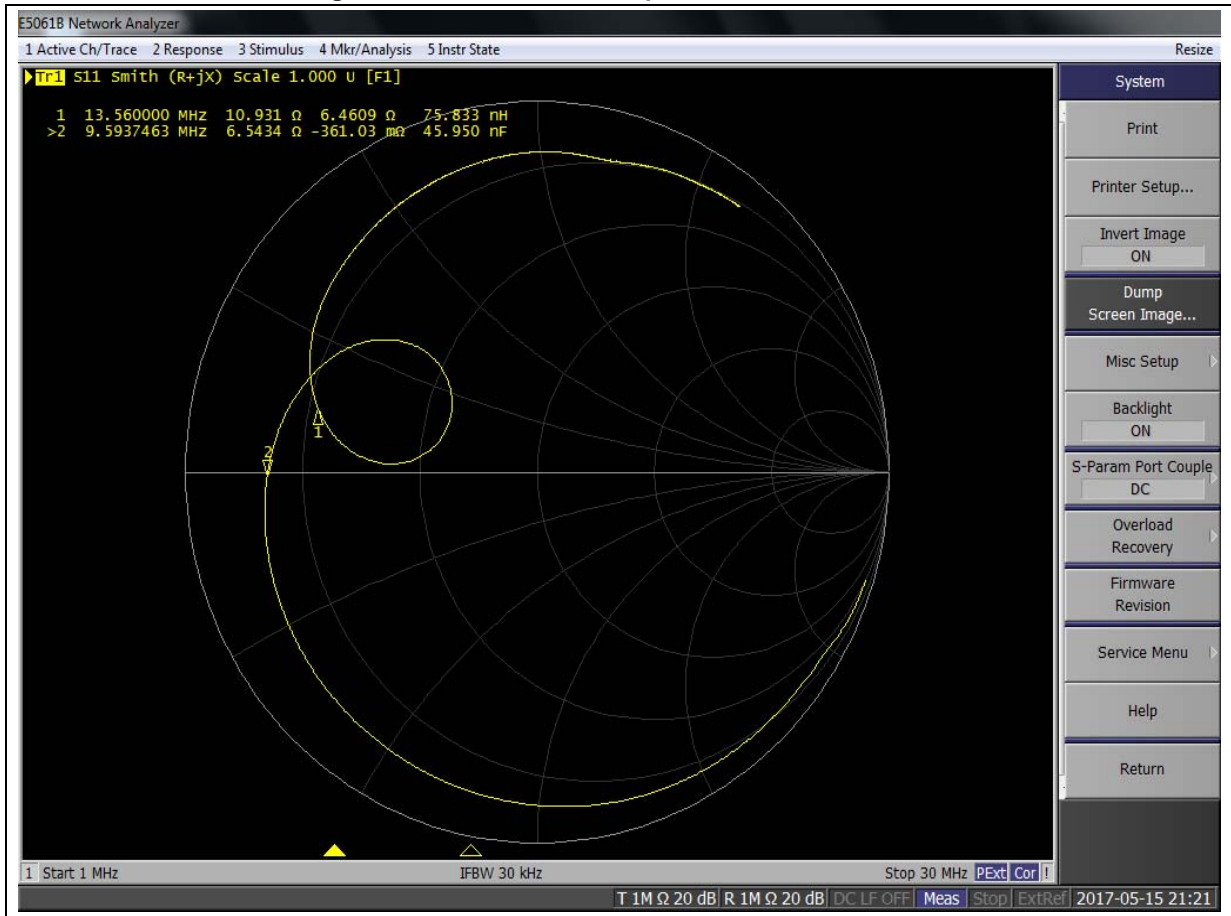

Conditions:

- $Z = 10.9 \Omega + j6.5 \Omega$ at 13,56 MHz; $|Z| = 12.7 \Omega$
- Current consumption: 220.6 mA

2.13 Trim value 12

Figure 14. Trim value 12 impedance measurement

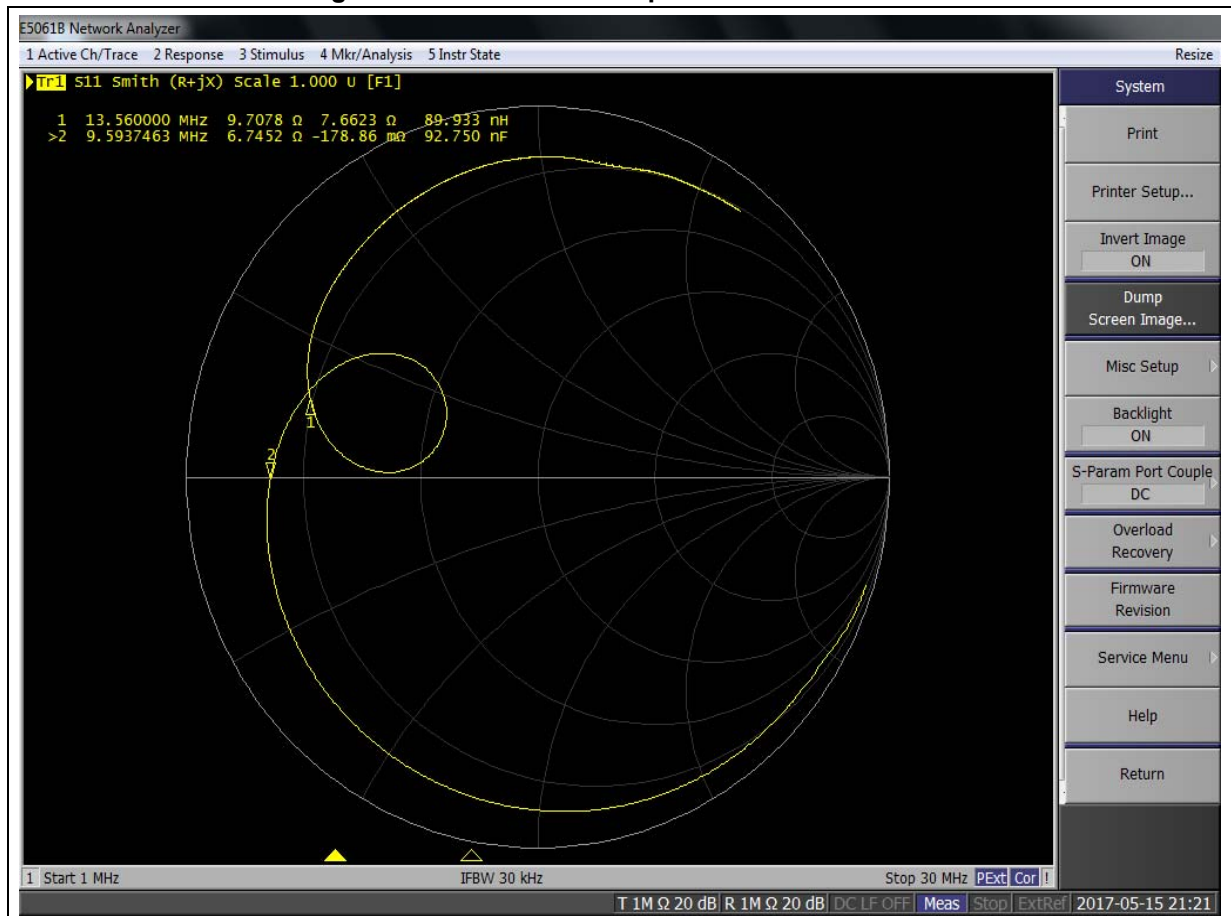

Conditions:

- $Z = 9.7 \Omega + j7.66 \Omega$ at 13,56 MHz; $|Z| = 12.4 \Omega$
- Current consumption: 217.4 mA

2.14 Trim value 13

Figure 15. Trim value 13 impedance measurement

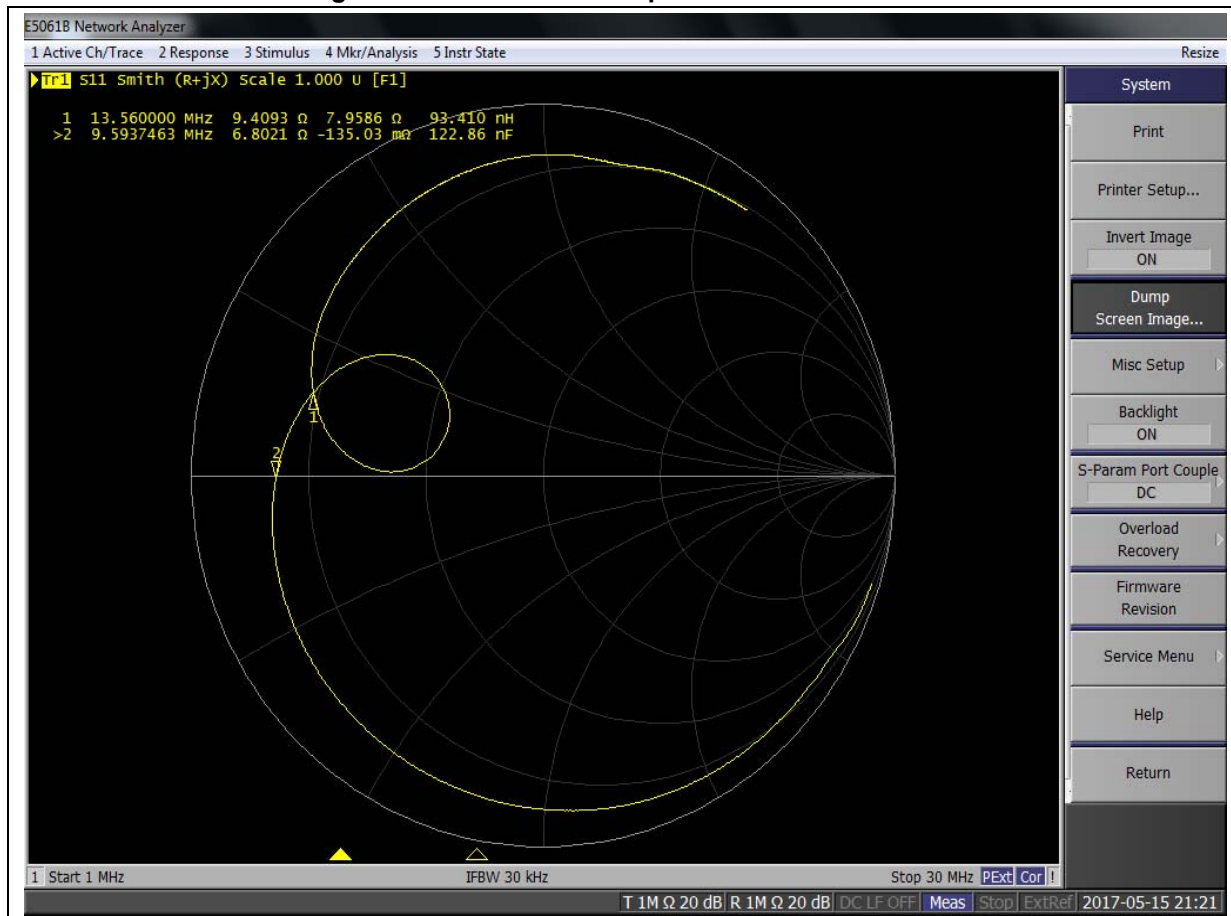

Conditions:

- $Z = 9.4 \Omega + j8 \Omega$ at 13,56 MHz; $|Z| = 12.3 \Omega$
- Current consumption: 214.7 mA

2.15 Trim value 14

Figure 16. Trim value 14 impedance measurement

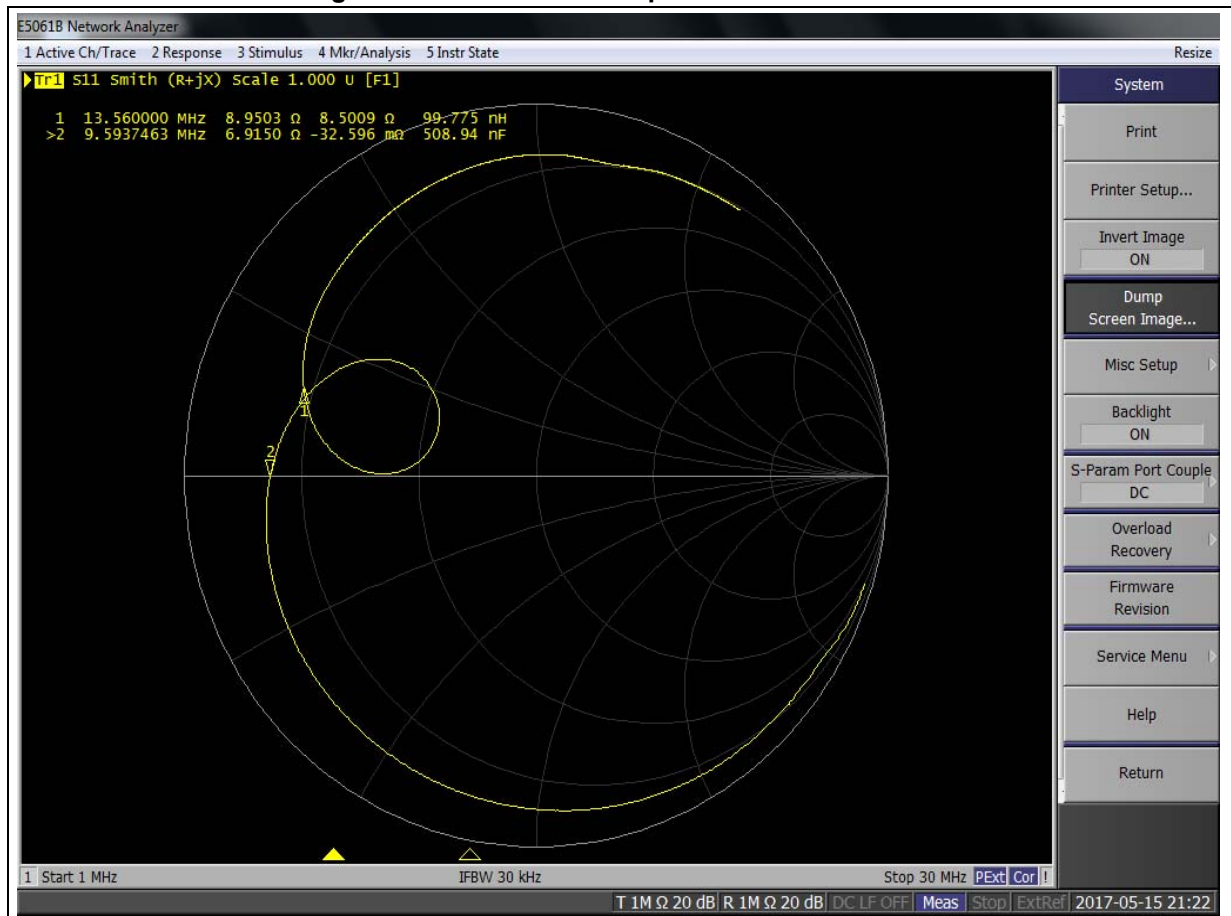

Conditions:

- $Z = 9 \Omega + j8.5 \Omega$ at 13,56 MHz; $|Z| = 12.3 \Omega$
- Current consumption: 210.2 mA

2.16 Trim value 15

Figure 17. Trim value 15 impedance measurement

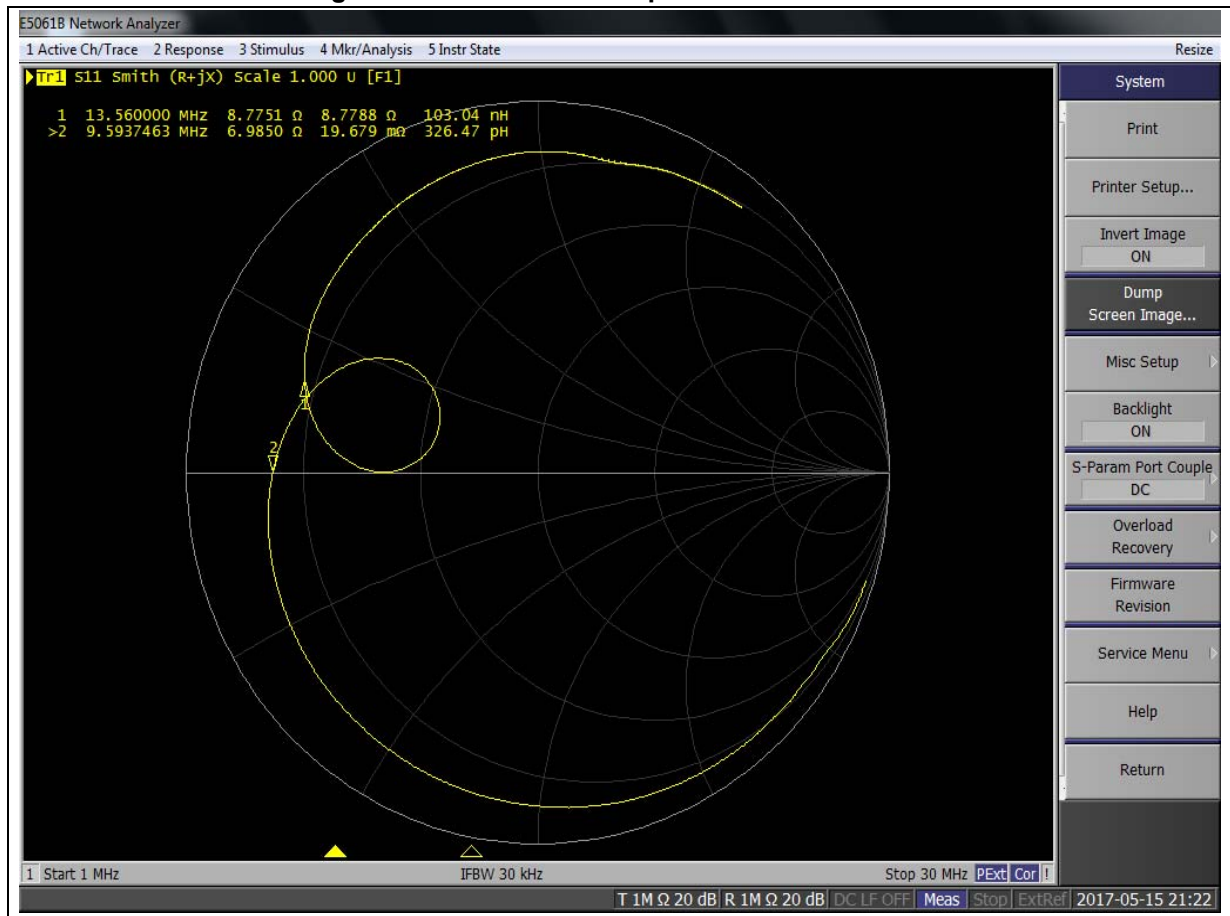

Conditions:

- $Z = 8.8 \Omega + j8.8 \Omega$ at 13,56 MHz; $|Z| = 12.4 \Omega$
- Current consumption: 207 mA

3 GUI

Figure 18, Figure 19 and Figure 20 show the Antenna Features tab. In this tab it is possible to select the AAT algorithms and change the targets of the phase difference, and of the input-signal amplitude.

Table 2. AAT algorithms selectable options

Algorithm	Max amplitude	Target phase	Target amplitude
HW based	X	-	-
SW based, optimize for phase	-	X	-
SW based, optimize for amplitude	-	-	X

Figure 18 shows the hardware-based AAT. This algorithm searches primarily the maximum amplitude of the input signal by changing the trim value. The target phase plays a minor role.

Using the HW based algorithm, it is necessary to check the trim result. The bit `tri_err` indicates whether or not the execution was successful. If `tri_err = 1`, error handling has to be done.

Figure 18. Antenna Feature, HW based AAT

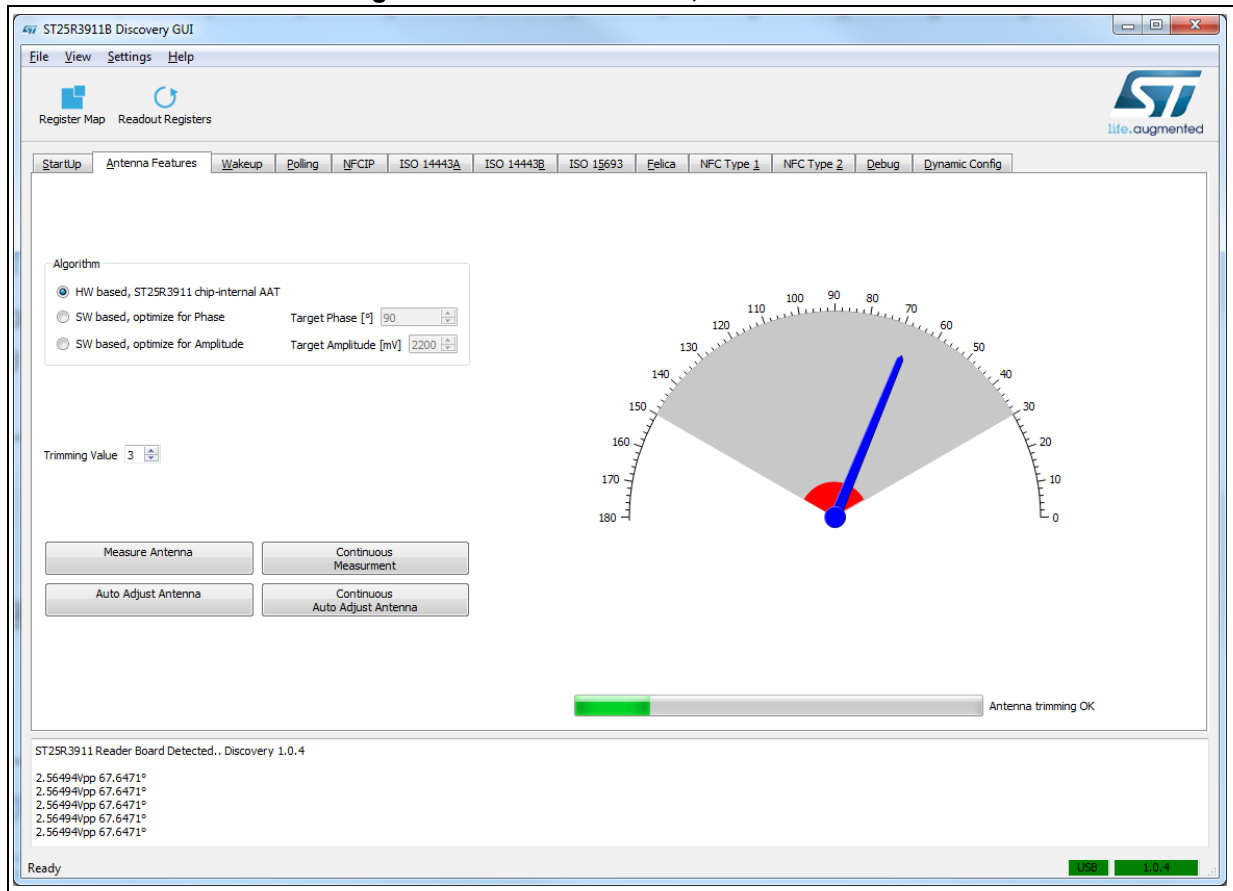

The SW based algorithm, optimized for phase AAT is shown in *Figure 19*. This algorithm find the value closest to the target phase. A sweep of all trim values is carried out and the trim value which leads to a phase closest to the target phase is chosen. The log window shows the measured results of all trim values and the selected trim value.

Figure 19. Antenna Feature, SW based, optimized for phase AAT

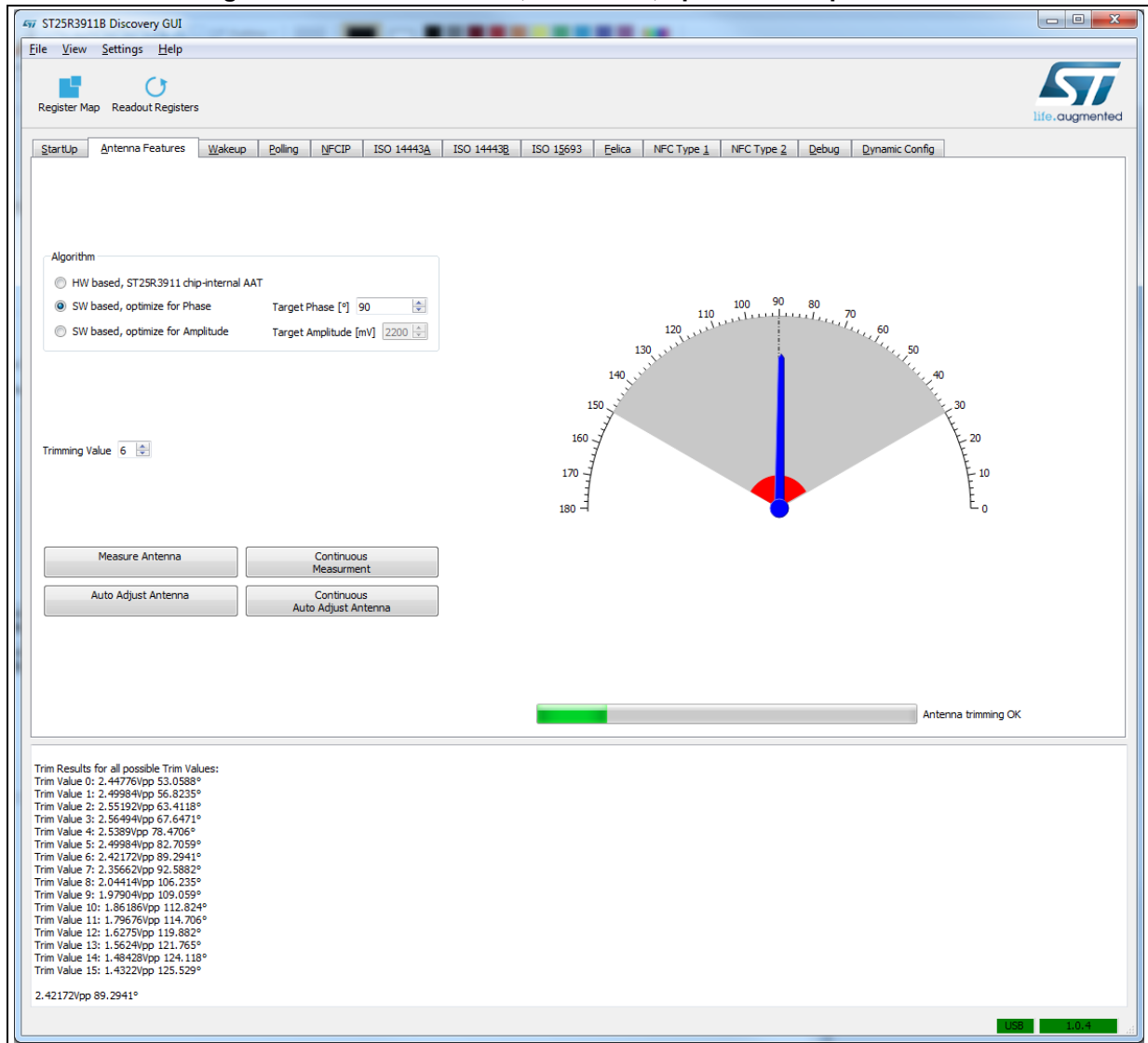

The SW based algorithm, optimized for Amplitude AAT is shown in [Figure 20](#). This algorithm find the closest value to the target amplitude. A sweep of all trim values is carried out and the trim value with the amplitude closest to the target amplitude is chosen. The log window shows the measured results of all trim values and the selected trim value.

Figure 20. Antenna Feature, SW based, optimized for amplitude AAT

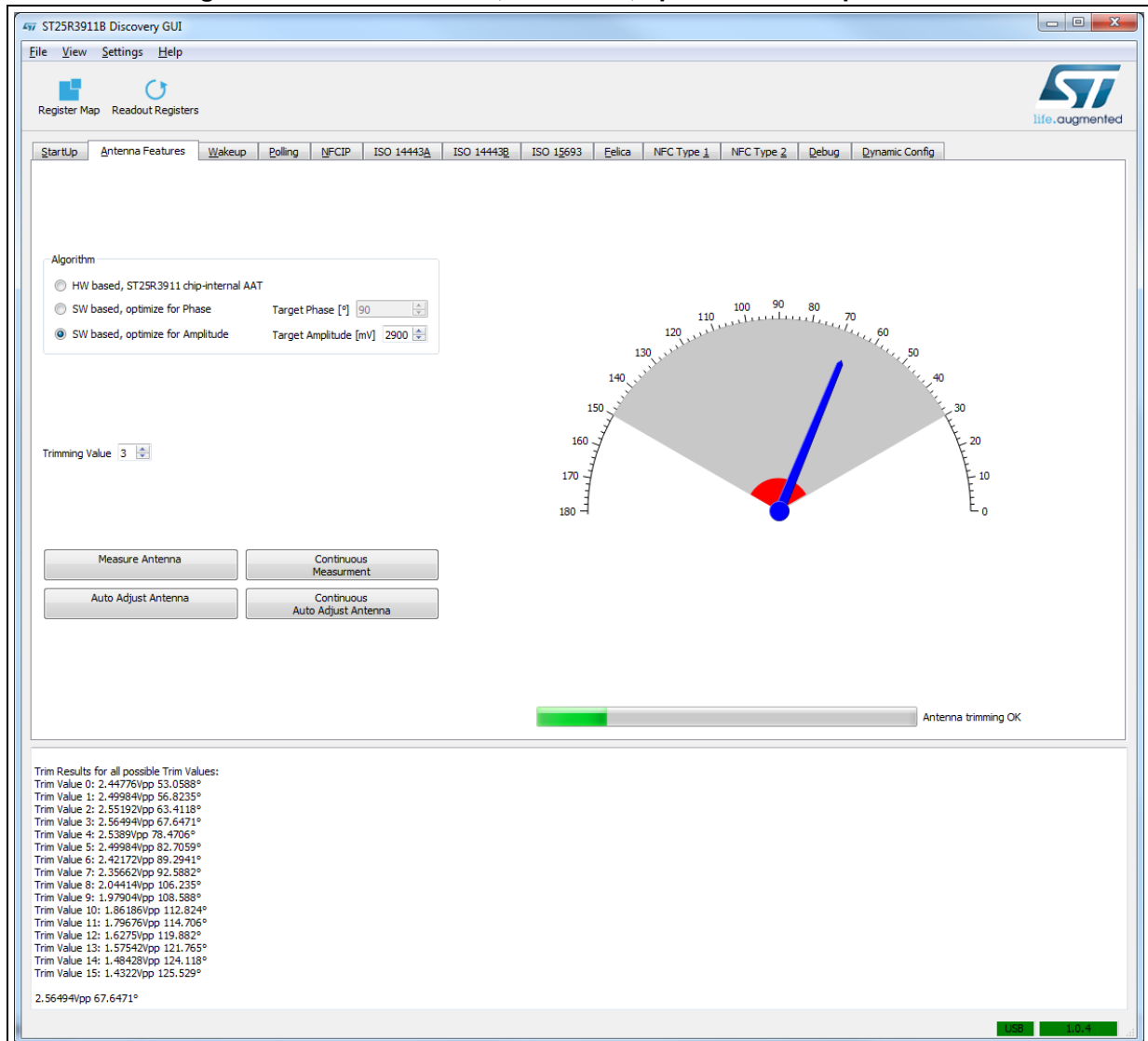

4 Conclusion

All three algorithms introduced in this application note can be used to optimize performance. The hardware-based AAT algorithms are the simplest to use as it only requires the calling of a direct command, waiting for the interrupt and evaluating the result.

The software-based AAT algorithms allow greater flexibility in the optimization criteria. This application note describes one software AAT algorithm to tune for a target phase value and one software AAT algorithm to tune for a target amplitude. These algorithms are executed in a microcontroller and therefore are adaptable based on application requirements and use-cases.

All three algorithms are evaluated using the ST25R3911B-DISCO GUI and the source code of the software-based AAT algorithms is part of the ST25R3911B-DISCO GUI package.

5 Revision history

Table 3. Document revision history

Date	Revision	Changes
21-Aug-2017	1	Initial release.
10-Oct-2017	2	Added Table 1: Applicable devices .

IMPORTANT NOTICE – PLEASE READ CAREFULLY

STMicroelectronics NV and its subsidiaries ("ST") reserve the right to make changes, corrections, enhancements, modifications, and improvements to ST products and/or to this document at any time without notice. Purchasers should obtain the latest relevant information on ST products before placing orders. ST products are sold pursuant to ST's terms and conditions of sale in place at the time of order acknowledgement.

Purchasers are solely responsible for the choice, selection, and use of ST products and ST assumes no liability for application assistance or the design of Purchasers' products.

No license, express or implied, to any intellectual property right is granted by ST herein.

Resale of ST products with provisions different from the information set forth herein shall void any warranty granted by ST for such product.

ST and the ST logo are trademarks of ST. All other product or service names are the property of their respective owners.

Information in this document supersedes and replaces information previously supplied in any prior versions of this document.

© 2017 STMicroelectronics – All rights reserved