



PLC actuator high-side driver solution with CMOS interface based on VN808CM-E High-side Driver

Main Features

- 8 output channels (8 x 0.7A)
- 1 feedback channel - diagnostic
- CMOS compatible signals allow direct connection to a microcontroller
- Outputs + Diagnostic indicated by LEDs
- EMC Immunity Proof $\pm 4\text{kV}$ level EFT (IEC 61000-4-4), $\pm 2\text{kV}$ Voltage Surge (IEC 61000-4-5)
- Compatible with existing ST tools (CANIC10, ARMIC30 ...)
- 10.5 ÷ 33V DC Supply Voltage range

Introduction

This application note describes the STEVAL-IFP001V1 hardware implementation. It focus on PCB design which is critical for EMC immunity robustness and thermal management.

The VN808CM-E is a monolithic device designed in STMicroelectronics VIPower M0-3 technology. The product is intended for driving any kind of load with one side connected to ground. It can be driven by using a 5.0V or 3.3V logic supply. This allows realizing an output stage without optical decoupling or another level-shifting. Active current limitation, combined with thermal shutdown and automatic restart, protect the device against accidental or long-time short circuit and overload.

The complete solution is implemented on a double-face board with only two copper layers which is cost-effective, also precision of routing is cost-optimized.

STEVAL-IFP001V1 is delivered in a set with CD-ROM including board fabrication data (Gerber files), this user manual and related devices documentation (for latest information, please have a look at www.st.com).

Contents

1	Overview	5
2	Connectors	6
3	Connection description	7
4	Thermal management	9
5	EMC Immunity testing	9
6	Technical data	10
7	Reference documents	10
Appendix A Bill of materials		11
Appendix B PCB layout		12
Revision history		14

List of tables

Table 1.	Connectors JP1 and JP2 signal assignments	6
Table 2.	EMC Immunity standards	9
Table 3.	STEVAL-IFP001V1 technical data	10
Table 4.	List of components	11
Table 5.	Document revision history	14

List of figures

Figure 1.	STEVAL-IFP001V1 application - top view	5
Figure 2.	STEVAL-IFP001V1 application - bottom view	5
Figure 3.	JP1 connector pinout	6
Figure 4.	JP2 connector pinout	6
Figure 5.	Reverse polarity protection	7
Figure 6.	Application schematic diagram	8
Figure 7.	Thermal vias placement suggestion	9
Figure 8.	PCB - top layer	12
Figure 9.	PCB - bottom layer	12
Figure 10.	PCB - silk screen top	13
Figure 11.	PCB - silk screen bottom	13

1 Overview

Application is built on double-face, FR4 substrate, printed circuit board with 35µm copper plating. PCB dimensions are 94 mm x 74 mm.

Figure 1. STEVAL-IFP001V1 application - top view

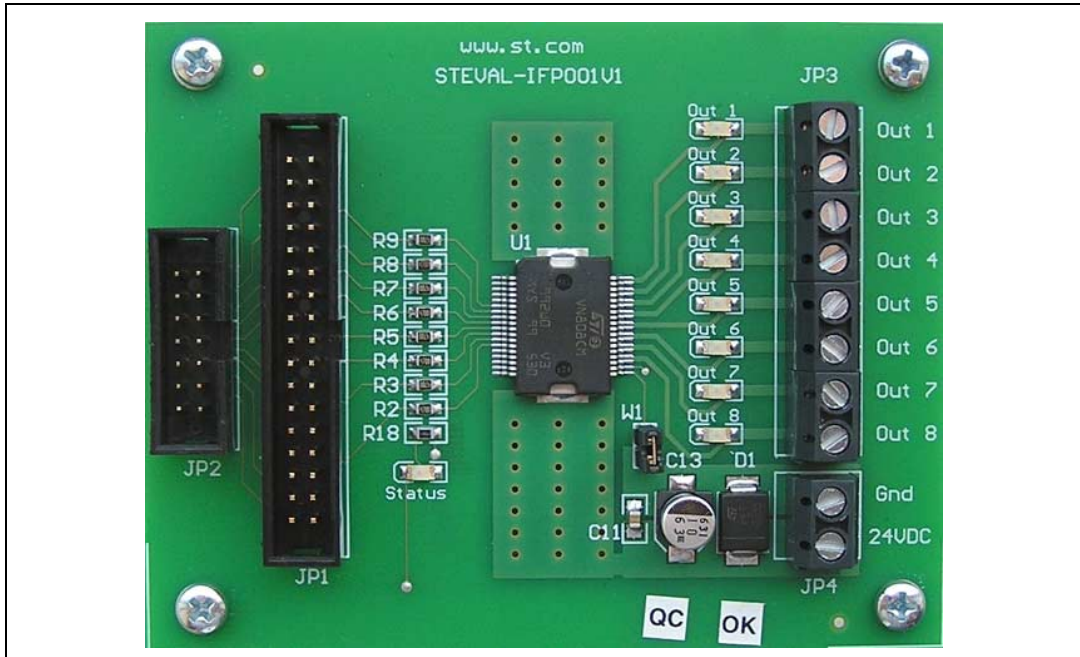
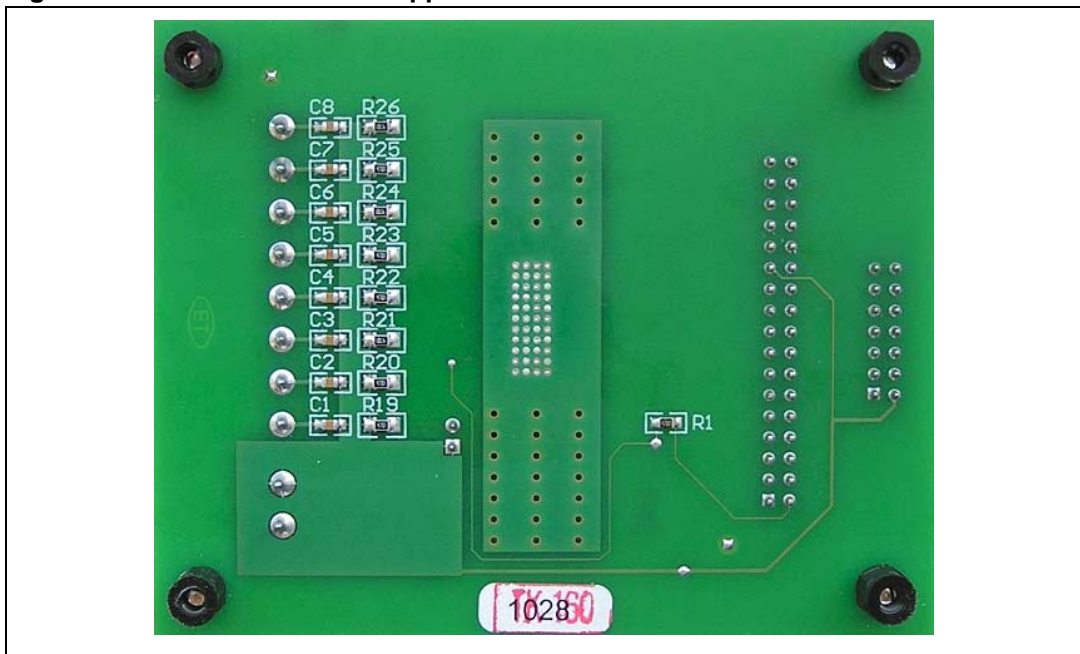

Figure 2. STEVAL-IFP001V1 application - bottom view



2 Connectors

The application uses two input connectors, one output and one supply voltage terminal. Both input connectors (JP1 and JP2) provide the same signals, the difference is in type and pinout. The location of connector JP1 ensures better compatibility with existing tools (primarily used for motor control).

Figure 3. JP1 connector pinout

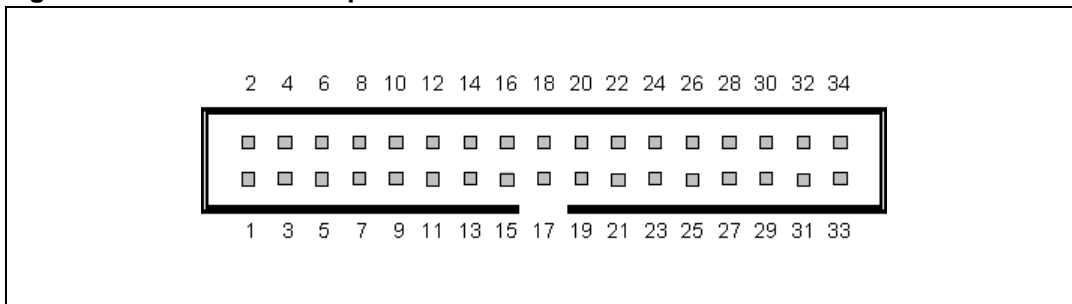

Figure 4. JP2 connector pinout

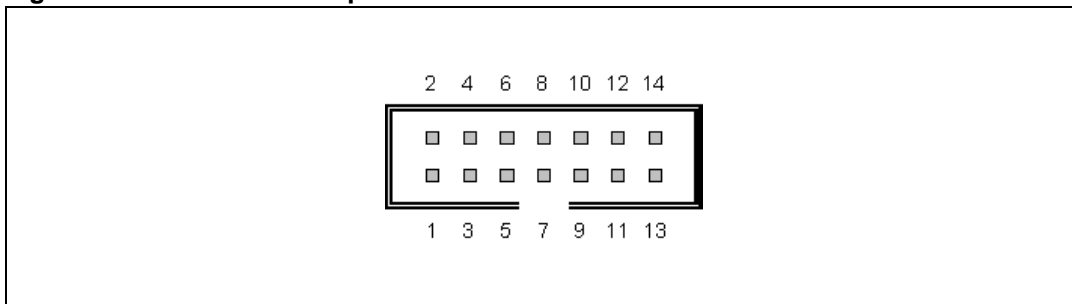

Table 1. Connectors JP1 and JP2 signal assignments

JP1 pin number	JP2 pin number	Signal	Type
2	3	Status	Output
4	4	Input 8	Input
10	5	Input 7	Input
14	6	Input 6	Input
20	7	Input 5	Input
22	8	Input 4	Input
23	2	GND	Ground - reference
26	9	Input 3	Input
28	10	Input 2	Input
32	11	Input 1	Input

3 Connection description

The application is connected as shown in [Figure 6](#). It is not intended for a standalone operation and a control unit is necessary to provide the input signals. The control unit can be connected either to connector JP1 or JP2. Resistors R1 to R9 protect the control unit and prevent latch-up. Their value can be extended up to approximately 10k Ω depending on the application requirements.

Output states of the VN808CM-E device are monitored by LEDs DS2 to DS9. DS1 is used for diagnostic purposes. The STATUS pin of the VN808CM-E with its open source structure provides typically 3mA current in case of over-temperature conditions. GND of the device is typically connected by jumper W1. To ensure the reverse polarity protection, replace this jumper by a parallel combination of a resistor (e.g. 1k Ω) and diode (universal or schottky) as shown in [Figure 5](#).

Output capacitors C1 to C8 improve application EMC immunity robustness, especially for compliance with standard 61000-4-6 - Immunity to conducted disturbances.

Figure 5. Reverse polarity protection

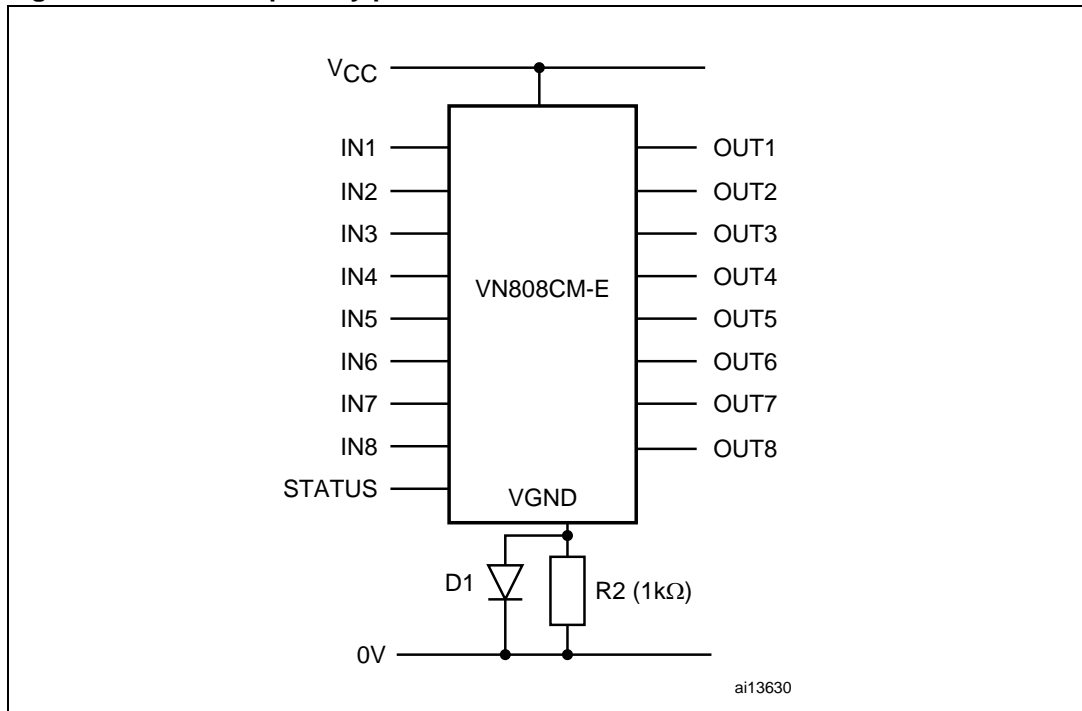
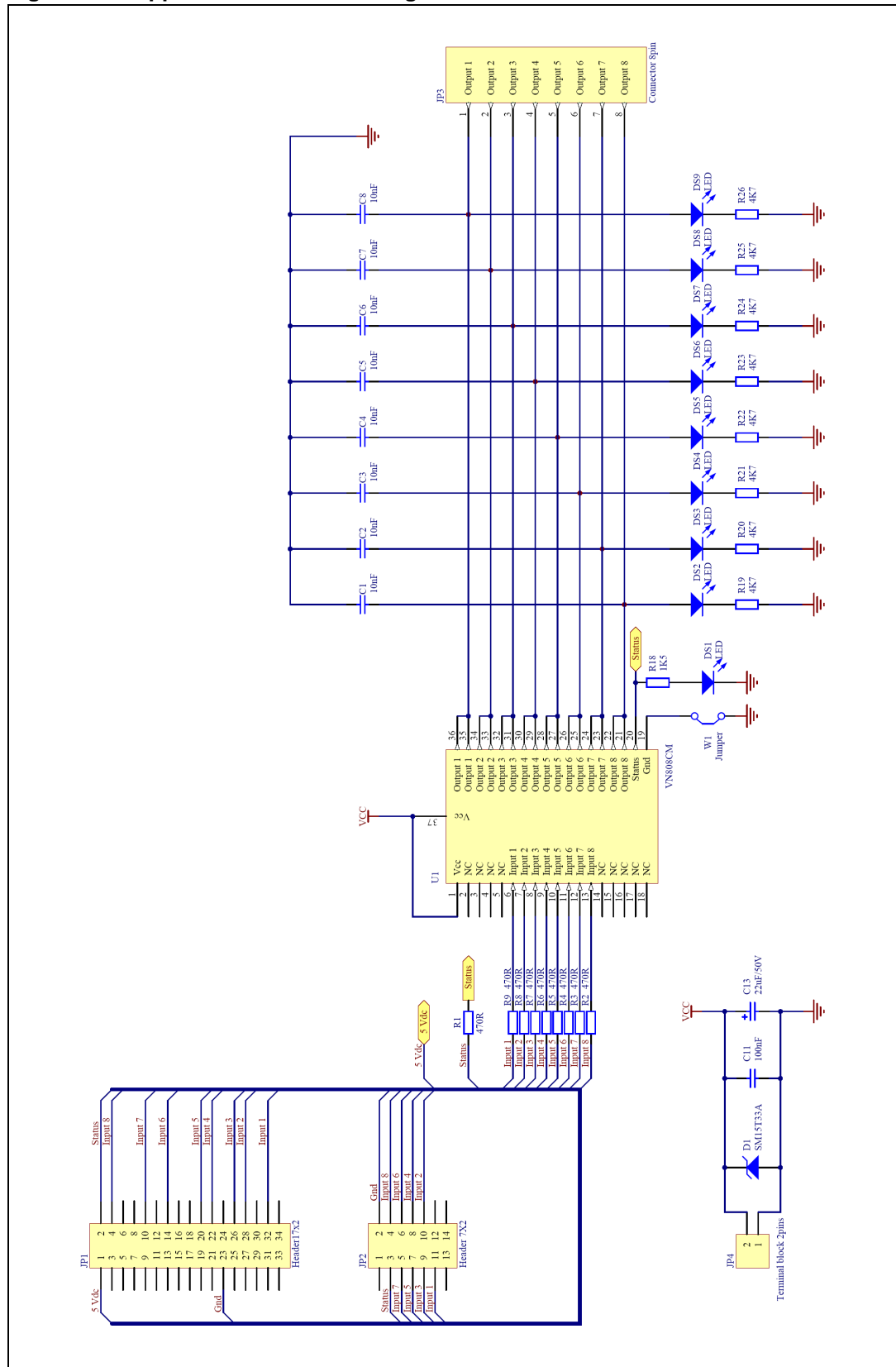

Figure 6. Application schematic diagram



4 Thermal management

The PCB includes a 14 x 53mm heatsink on both the top and bottom layers. Both heatsinks are thermally interconnected with vias. Another via grid is placed directly under the device exposed pad. This grid creates a low-resistive thermal connection of the device thermal slug to the bottom copper layer. Via drill holes should be approximately 0.3mm in diameter and the orthogonal grid approximately 1.2mm as shown in [Figure 7](#).

Figure 7. Thermal vias placement suggestion

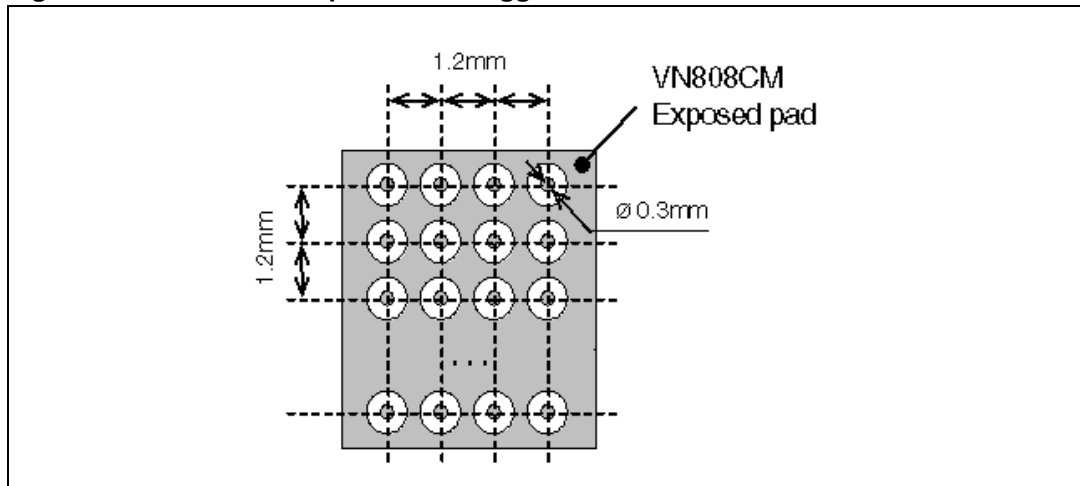

5 EMC Immunity testing

The application was tested according to electromagnetic compatibility (EMC) immunity standards IEC61000-4-4 (Fast Transient Burst) and IEC61000-4-5 (High Energy Surge).

The Fast Transient Burst test lasted approximately 1 minute with ± 4 kV and a repetition rate of 5 kHz. All channels were in Switching mode with a frequency of approximately 1Hz. The burst signal was applied using a capacitive coupling clamp tool.

The High Energy Surge test was performed only in Differential mode (no protective GND available). The signal was coupled by a 42Ω impedance. The test contained five positive and five negative discharges. The repetition rate was 1 discharge per minute.

The application worked properly during and after the tests. [Table 2](#) shows the test results.

Table 2. EMC Immunity standards

Applied to/ Standard	IEC61000-4-4	IEC61000-4-5 (Differential Mode)
Supply voltage lines	± 4 kV Criteria A	± 2 kV Criteria A
Output port	± 4 kV Criteria A	± 2 kV Criteria A

Application note AN2208 (see [Section 7: Reference documents](#)) provides specific information about test setups.

6 Technical data

Table 3. STEVAL-IFP001V1 technical data⁽¹⁾

Parameter	Min.	Typ.	Max.	Unit
Board Supply Voltage range (recommended)	10.5		33	V DC
Output current per channel (nominal value)		0.5		A DC
Output low level voltage			3	V DC
Supply leakage current @ 24VDC, all inputs grounded		88		μA DC
Input signal low level voltage	0		1.25	V DC
Input signal high level voltage	2.25		6	V DC

1. These values are for information only.

7 Reference documents

- [1] AN1351 - VIPower AND BCDmultipower: Making Life Easier with ST's High-side Drivers
- [2] AN2208 - Designing Industrial Applications with VN808/VN340SP High-side Drivers

Appendix A Bill of materials

Table 4. List of components

Quantity	Reference	Part	Description
Capacitors			
8	C1-C8	10nF	Ceramic capacitor SMD size 0805, 50V
1	C11	100nF	Ceramic capacitor SMD size 0805, 50V
1	C13	22uF	Electrolytic capacitor 22uF/50V, SMD +/-20%
Diodes			
1	D1	SM15T33A	Transil diode, 33V
9	DS1-DS9	LED 1206	LED SMD size 1206, green color
Mechanical parts			
1	JP1	MLW34G	34-pin header - dual in line with lock 2.54x2.54mm pitch
1	JP2	MLW14G	14-pin header - dual in line with lock 2.54x2.54mm pitch
4	JP3	ARK508 – 2P	4 x terminal block 5.08mm pitch
1	JP4	ARK508 – 2P	1 x terminal block 5.08mm pitch
1	W1	Jumper	2-pin header 2.54mm pitch
Resistors			
9	R1-R9	470R	Resistor, SMD size 0805, 150V/300V, 0.125W, 5%
1	R18	1k5	Resistor, SMD size 0805, 150V/300V, 0.125W, 5%
8	R19-R26	4k7	Resistor, SMD size 0805, 150V/300V, 0.125W, 5%
ICs			
1	U1	VN808CM-E	STMicroelectronics, VN808CM-E, Octal high side driver

Appendix B PCB layout

Figure 8. PCB - top layer

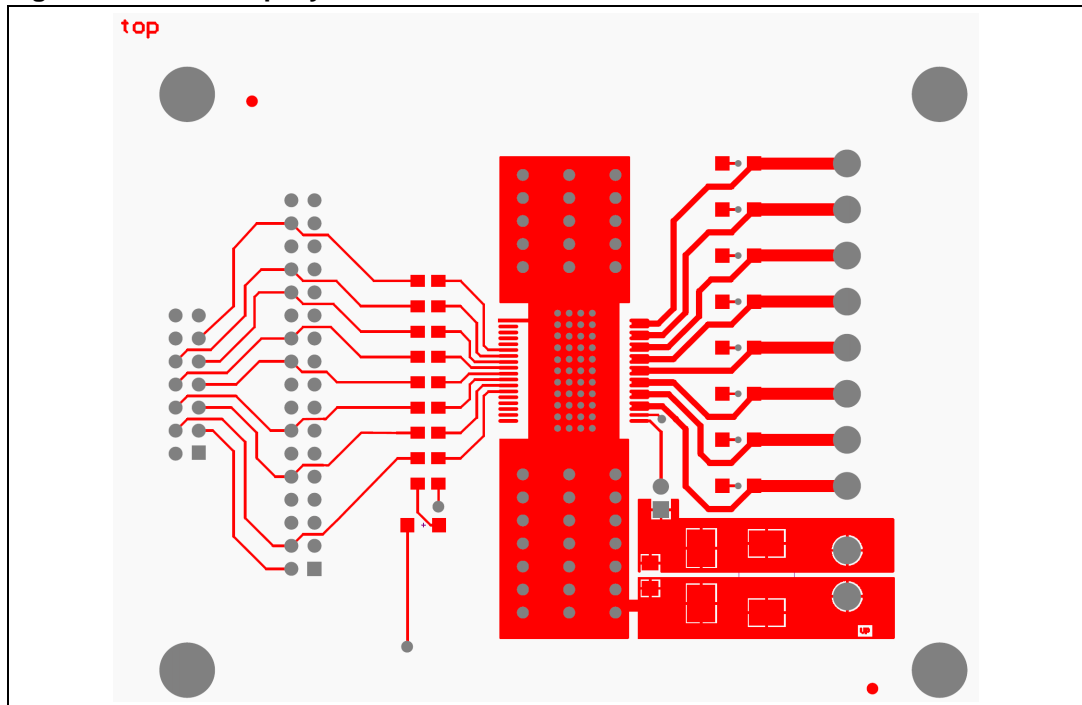

Figure 9. PCB - bottom layer

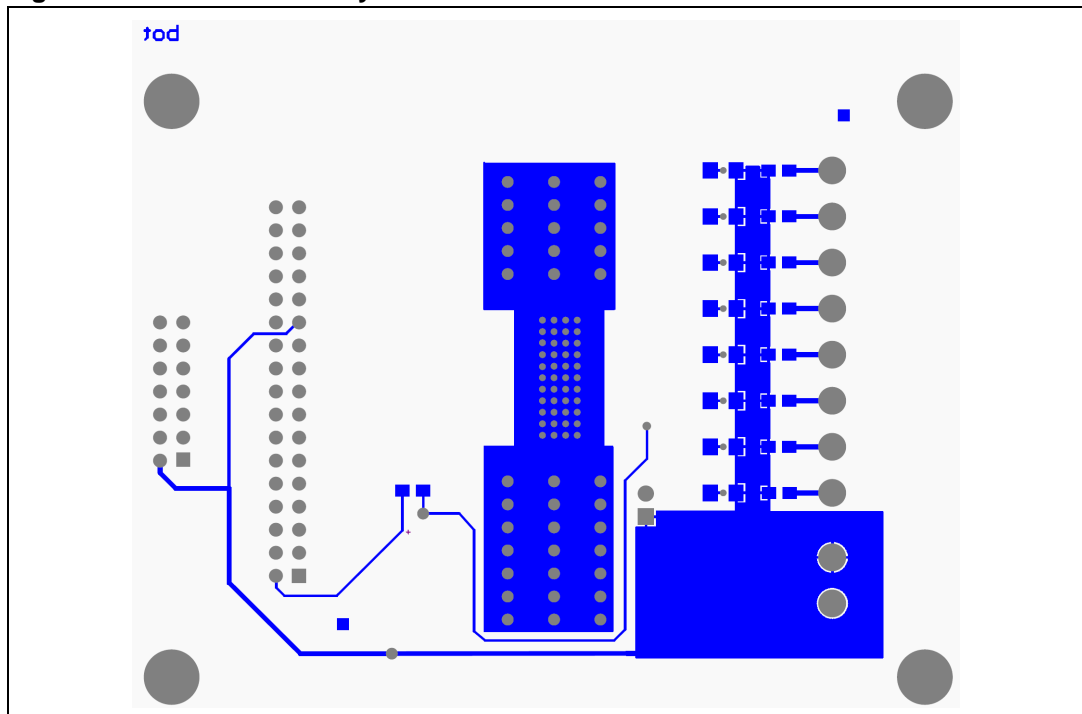

Figure 10. PCB - silk screen top

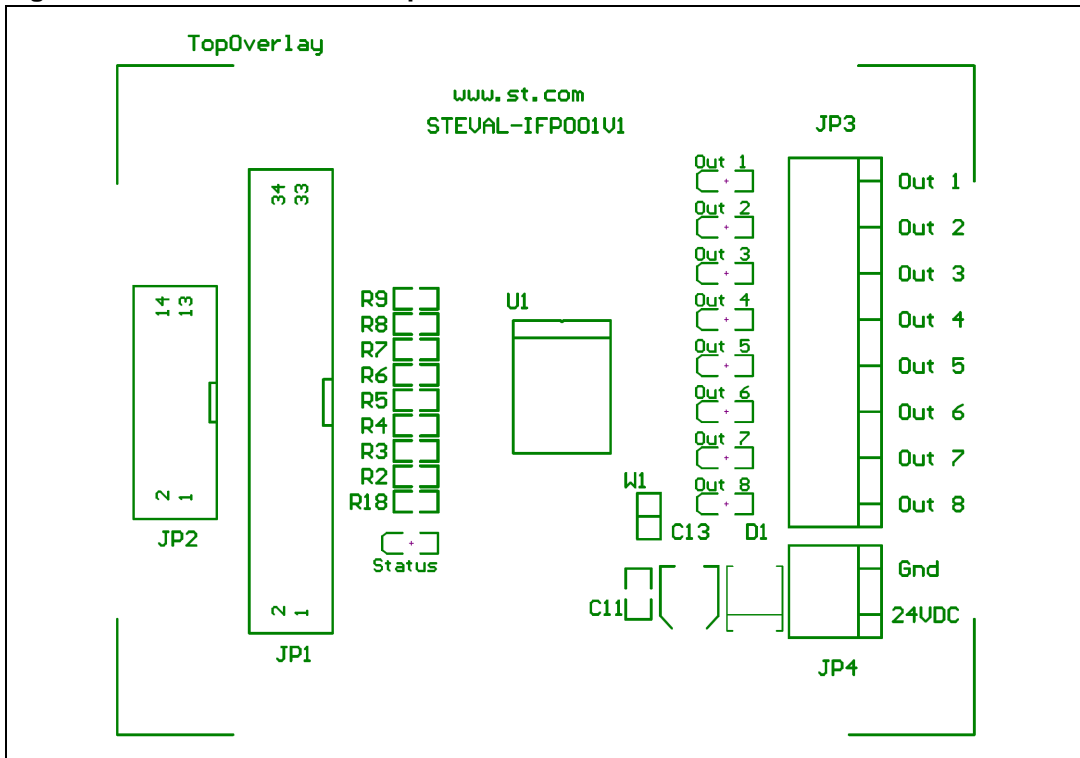
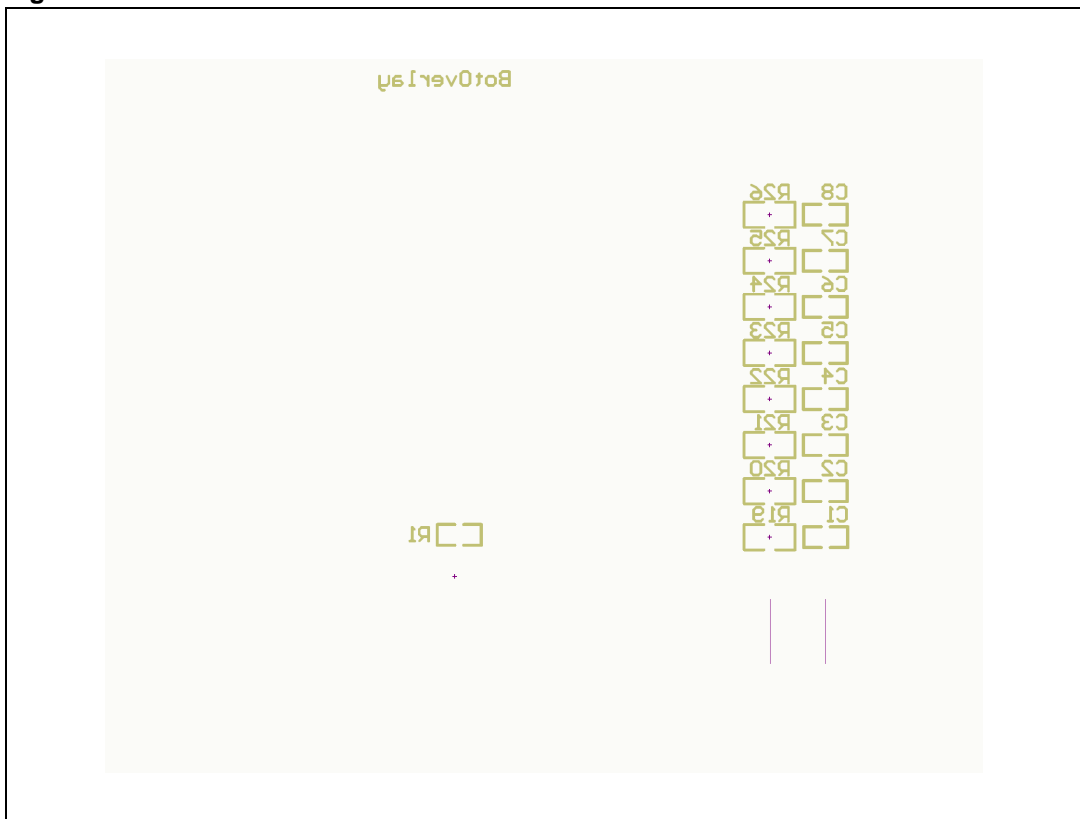

Figure 11. PCB - silk screen bottom



Revision history

Table 5. Document revision history

Date	Revision	Changes
05-Dec-2006	1	Initial release.
14-Dec-2006	2	<i>Figure 5: Reverse polarity protection</i> updated.

Please Read Carefully:

Information in this document is provided solely in connection with ST products. STMicroelectronics NV and its subsidiaries ("ST") reserve the right to make changes, corrections, modifications or improvements, to this document, and the products and services described herein at any time, without notice.

All ST products are sold pursuant to ST's terms and conditions of sale.

Purchasers are solely responsible for the choice, selection and use of the ST products and services described herein, and ST assumes no liability whatsoever relating to the choice, selection or use of the ST products and services described herein.

No license, express or implied, by estoppel or otherwise, to any intellectual property rights is granted under this document. If any part of this document refers to any third party products or services it shall not be deemed a license grant by ST for the use of such third party products or services, or any intellectual property contained therein or considered as a warranty covering the use in any manner whatsoever of such third party products or services or any intellectual property contained therein.

UNLESS OTHERWISE SET FORTH IN ST'S TERMS AND CONDITIONS OF SALE ST DISCLAIMS ANY EXPRESS OR IMPLIED WARRANTY WITH RESPECT TO THE USE AND/OR SALE OF ST PRODUCTS INCLUDING WITHOUT LIMITATION IMPLIED WARRANTIES OF MERCHANTABILITY, FITNESS FOR A PARTICULAR PURPOSE (AND THEIR EQUIVALENTS UNDER THE LAWS OF ANY JURISDICTION), OR INFRINGEMENT OF ANY PATENT, COPYRIGHT OR OTHER INTELLECTUAL PROPERTY RIGHT.

UNLESS EXPRESSLY APPROVED IN WRITING BY AN AUTHORIZED ST REPRESENTATIVE, ST PRODUCTS ARE NOT RECOMMENDED, AUTHORIZED OR WARRANTED FOR USE IN MILITARY, AIR CRAFT, SPACE, LIFE SAVING, OR LIFE SUSTAINING APPLICATIONS, NOR IN PRODUCTS OR SYSTEMS WHERE FAILURE OR MALFUNCTION MAY RESULT IN PERSONAL INJURY, DEATH, OR SEVERE PROPERTY OR ENVIRONMENTAL DAMAGE. ST PRODUCTS WHICH ARE NOT SPECIFIED AS "AUTOMOTIVE GRADE" MAY ONLY BE USED IN AUTOMOTIVE APPLICATIONS AT USER'S OWN RISK.

Resale of ST products with provisions different from the statements and/or technical features set forth in this document shall immediately void any warranty granted by ST for the ST product or service described herein and shall not create or extend in any manner whatsoever, any liability of ST.

ST and the ST logo are trademarks or registered trademarks of ST in various countries.

Information in this document supersedes and replaces all information previously supplied.

The ST logo is a registered trademark of STMicroelectronics. All other names are the property of their respective owners.

© 2006 STMicroelectronics - All rights reserved

STMicroelectronics group of companies

Australia - Belgium - Brazil - Canada - China - Czech Republic - Finland - France - Germany - Hong Kong - India - Israel - Italy - Japan - Malaysia - Malta - Morocco - Singapore - Spain - Sweden - Switzerland - United Kingdom - United States of America

www.st.com

