

---

**Soldering recommendations and package information for Lead-free  
ECOPACK MCUs and MPUs**

---

**Introduction**

STMicroelectronics MCUs and MPUs support various types of Lead-free ECOPACK package to meet customer requirements.

The mounting technologies are surface mount technology (SMT), and through hole technology (THT). Beside the available mounting technology, the choice is often driven by technical and economical concerns. This application note describes the various package types used, introduces the different mounting technologies, and gives soldering recommendations.

---

# Contents

<b>1</b>	<b>Lead-free packages at STMicroelectronics</b> .....	<b>3</b>
<b>2</b>	<b>Packages overview</b> .....	<b>4</b>
<b>3</b>	<b>SMD presentation</b> .....	<b>5</b>
3.1	Handling SMDs .....	5
<b>4</b>	<b>Soldering</b> .....	<b>6</b>
4.1	Soldering methods .....	6
	Bending leads .....	6
	Insertion .....	6
4.2	Soldering recommendations .....	7
4.3	Compatibility with leaded soldering process .....	7
4.4	Reflow soldering conditions .....	8
<b>5</b>	<b>SMD gluability</b> .....	<b>10</b>
<b>6</b>	<b>Dry packing</b> .....	<b>11</b>
6.1	Pop-corn effect .....	11
6.2	Dry pack opening .....	13
<b>7</b>	<b>Revision history</b> .....	<b>14</b>

# 1 Lead-free packages at STMicroelectronics

STMicroelectronics is fully committed to environment protection and sustainable development and started in 1997 a voluntary program for removing polluting and hazardous substances from all devices. In 2000, a strategic program, named ECOPACK has been officially launched to develop and implement solutions leading to environment friendly packaging and ban progressively Lead and other heavy metals from our manufacturing lines. ECOPACK is a registered trademark of STMicroelectronics.

STMicroelectronics ECOPACK products are RoHS compliant according to EU 2011/65/EU directive.

For more detailed information please go to <http://www.st.com>.

*Note: RoHS stands for 'Restriction of the use of certain Hazardous Substances'. It is specified by the directive 2011/65/EU of the European Parliament and of the Council of 8th June 2011 on the restriction of the use of certain hazardous substances in electrical and electronic equipment. This directive is the recast of the RoHS Directive 2002/95/EC of the European Parliament and of the Council of 27th January 2003 on the Restriction of the use of certain Hazardous Substances in Electrical and Electronic Equipment.*

## 2 Packages overview

The different packages available at STMicroelectronics are described in [Table 1](#).

**Table 1. Package types<sup>(1)</sup>**

Surface mount technology		Through hole technology	
Package	Pin count	Package	Pin count
SON	8, 16	PDIP .3	8, 16, 20
SOW	16, 20, 24, 28, 34 Shrink	PDIP .4	32S
PLCC	44, 520	PDIP .6	28, 42S, 56S
PQFP	44, 52, 80, 100, 144, 208	-	-
LQFP	Up to 208	-	-
LFBGA, UFBGA, TFBGA	Up to 216	-	-
TFBGA <sup>(2)</sup>	Up to 361	-	-
LFBGA <sup>(2)</sup>	Up to 448	-	-
PBGA	Up to 480	-	-
TSSOP	20	-	-
VFQFPN, UFQFPN	8, 20, 24, 28, 32, 36, 40, 48, 64	-	-
WLCSP	Up to 143	-	-

1. Larger package portfolio can be proposed upon request.

2. Specific to MPUs

Through hole technology (THT) and surface mount technology (SMT) imply different soldering technologies leading to different constraints.

In THT, the package body is exposed to relatively low temperatures (< 150 °C) because the lead extremities are only dipped in the soldering alloy, whereas in SMT the whole package body is exposed to a very high temperature (from 245 °C to 260 °C) during reflow soldering process.

In addition, molding compounds used for integrated circuit encapsulation absorb moisture from the ambient medium. During rapid heating in solder reflow process (see [Section 4: Soldering](#) for more details), this absorbed moisture can vaporize, generating pressure at lead frame pad / silicon to plastic interfaces in the package, with a risk of package cracking and potential degradation of device reliability.

## 3 SMD presentation

Unlike through hole technology where leads are inserted into the printed circuit board, SMD (surface mount device) package is attached directly onto mounting pads of the substrate. SMT is extensively used in electronic applications because it has the following advantages:

- Packages are smaller and support higher pin counts
- Packages are light and compact, thus reducing system sizes
- Mounting can be done on either side of the PCB
- No cost for drilling holes into the PCB

Surface mount technology also comes along with a few disadvantages:

- Increased sensitivity to soldering heat because of their thinner dimension
- Soldering conditions harder to determine (use of finer structures and higher pin count)

### 3.1 Handling SMDs

Though the intrinsic reliability of SMD packages is now excellent, the use of inappropriate techniques or unsuitable tools during mechanical handling can affect the long term reliability of the device, or even destroy it.

When handling a SMD package, it is strongly recommended to use adapted tools such as vacuum pipes to avoid touching the pins as much as possible. Manual handling could affect lead coplanarity and cause lead contamination or scratches that could generate solderability problems. It is also not allowed to widen the interval between two consecutive pins.

## 4 Soldering

### 4.1 Soldering methods

There are 3 main soldering methods (which are detailed in [Figure 1](#)):

- Single sided reflow soldering
- Double sided reflow soldering
- Wave soldering (for THT devices)

#### Bending leads

In all processes it is important to avoid straining the package and particularly the area where the leads enter the encapsulating resin. If the package/lead interface is strained the resistance to humidity and thermal stress will be compromised, affecting device reliability.

#### Insertion

When mounting devices on a printed circuit board the golden rule is, again, to avoid stress. In particular, adhere to the specified pin spacing of the device: do not try to bend the leads to fit non-standard hole spacing.

**Figure 1. Soldering method descriptions**

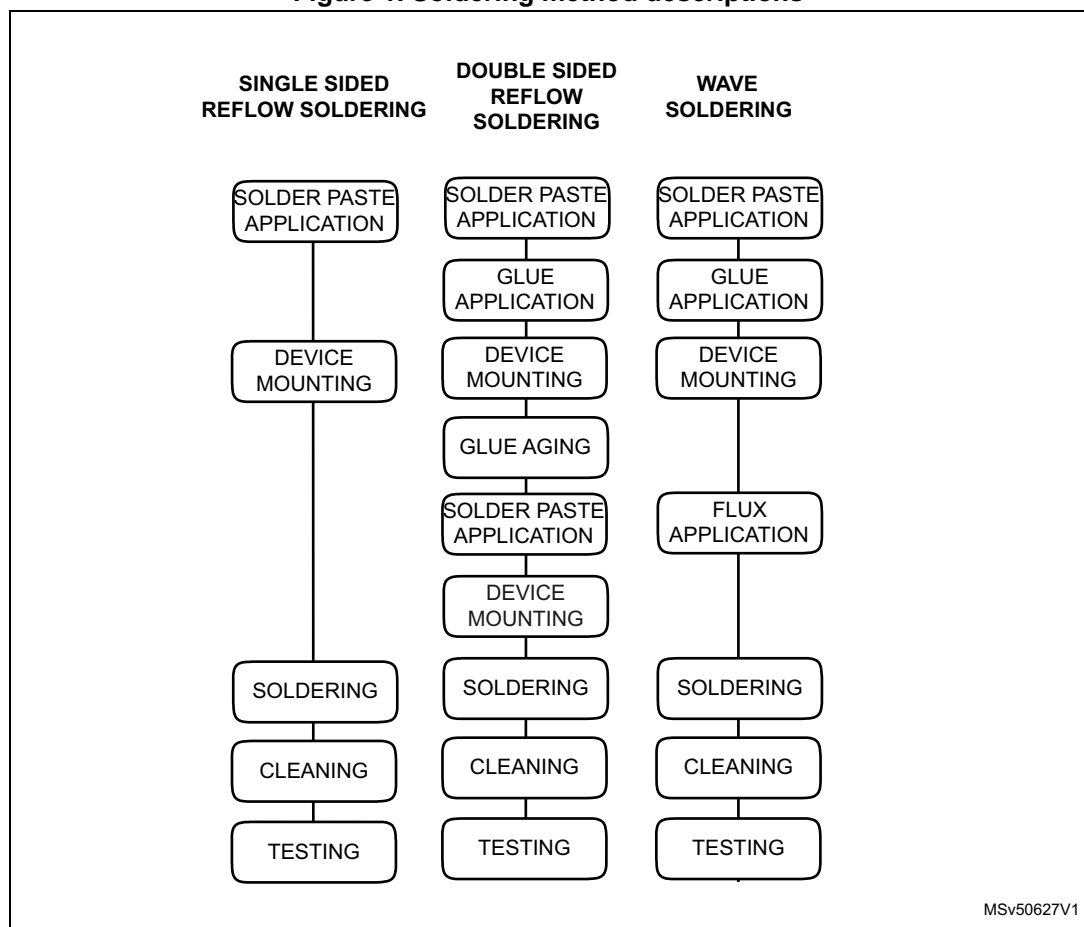

MSv50627V1

## 4.2 Soldering recommendations

The following recommendations must be followed for soldering each package type (see [Table 2](#)).

**Table 2. Package/soldering process compatibility<sup>(1)</sup>**

Package	Reflow processing process		Wave soldering process	
	Process	Reliability	Process	Reliability
PLCC	OK	OK	impossible	N/A
SOP	OK	OK	feasible	(2)
QFP	OK	OK	Under customer responsibility <sup>(3)</sup>	(2)
BGA	OK	OK	impossible	N/A
VFQFPN, UFQFPN	OK	OK	impossible	N/A
WLCSP	OK	OK	impossible	N/A

1. Reflow soldering with DIP and wave soldering with PLCC, BGA, VFQFPN, UFQFPN, and WLCSP are strictly impossible due to the lead/ball configuration.
2. Wave soldering with SMT packages is not qualified by STMicroelectronics. SMT package qualification performed as a standard by STMicroelectronics only includes infra-red reflow soldering. JEDEC JESD22A111 recommends that wave soldering of SMT packages is evaluated by the **user** because the stress induced inside the package may generate internal structural damage and closely depends on soldering process parameters.
3. Wave soldering with PQFP is not recommended because it is difficult to avoid solder bridges when leads pass through the double wave.

## 4.3 Compatibility with leaded soldering process

Lead-free packages can be assembled using leaded soldering process.

## 4.4 Reflow soldering conditions

The greater danger during reflow soldering is overheating. If an integrated circuit is exposed to high temperature for an excessive period of time, it may be damaged and its reliability reduced.

It is also important to use suitable fluxes for the soldering baths to avoid deterioration of the leads or package resin. Residual flux between the leads or in contact with the resin must be removed to guarantee long term reliability. The solvent used to remove excess flux should be chosen with care. It is particular true for trichloroethylene (CHCl: CCl<sub>2</sub>). Base solvents should be avoided because the residue could corrode the encapsulating resin.

High-quality low-defect soldering requires identifying the optimum temperature profile for reflowing the solder paste, thus optimizing the process. The heating and cooling rise rates must be compatible with the solder paste and components.

A typical profile consists of a preheat, dryout and reflow sections.

The most critical point in the preheat section is to minimize the temperature rise rate to less than 2 °C/second, in order to minimize thermal shock on the semiconductor components.

The dryout section is used primarily to ensure that the solder paste is fully dried before hitting reflow temperatures.

Solder reflow is accomplished in the reflow zone, where the solder paste is elevated to a temperature greater than the melting solder point. Melting temperature must be exceeded by approximately 20 °C to ensure quality reflow.

Figure 2. Typical reflow soldering profile

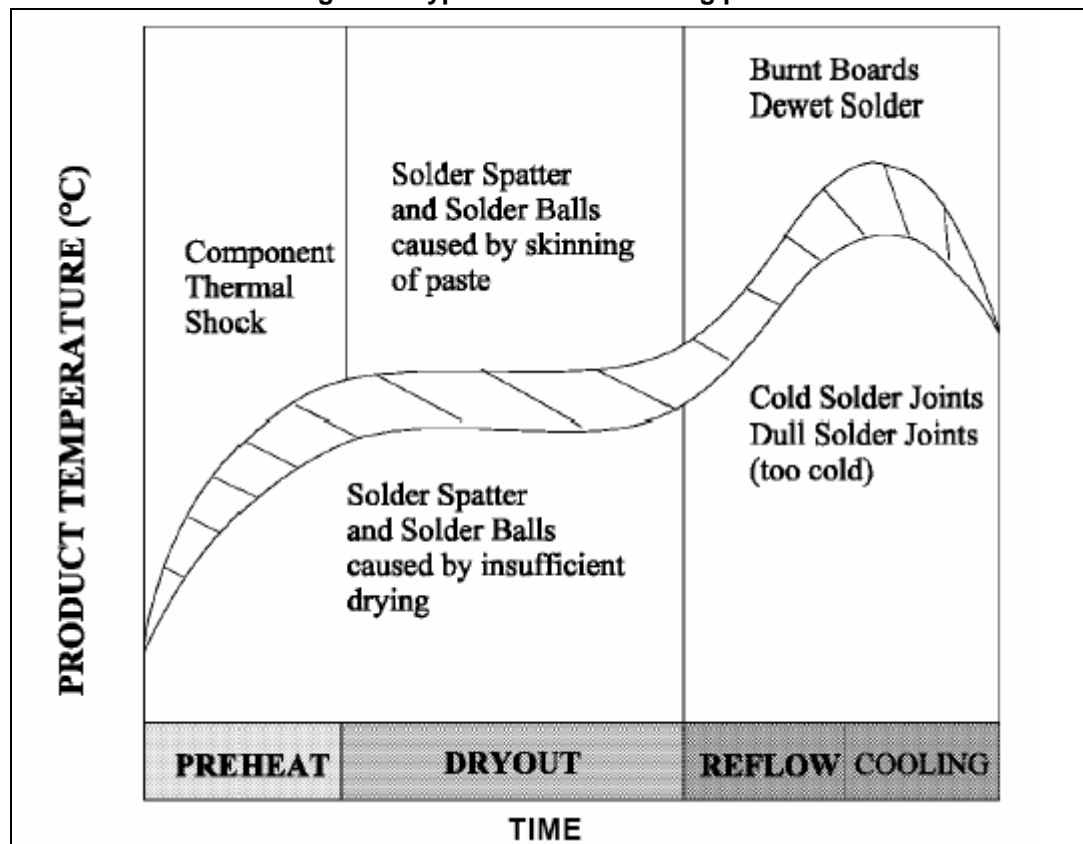



Refer to [Figure 3](#) for the recommended reflow soldering profiles.

STMicroelectronics Lead-free packages are warranted for such reflow profile conditions.

**Figure 3. Recommended reflow soldering profile**

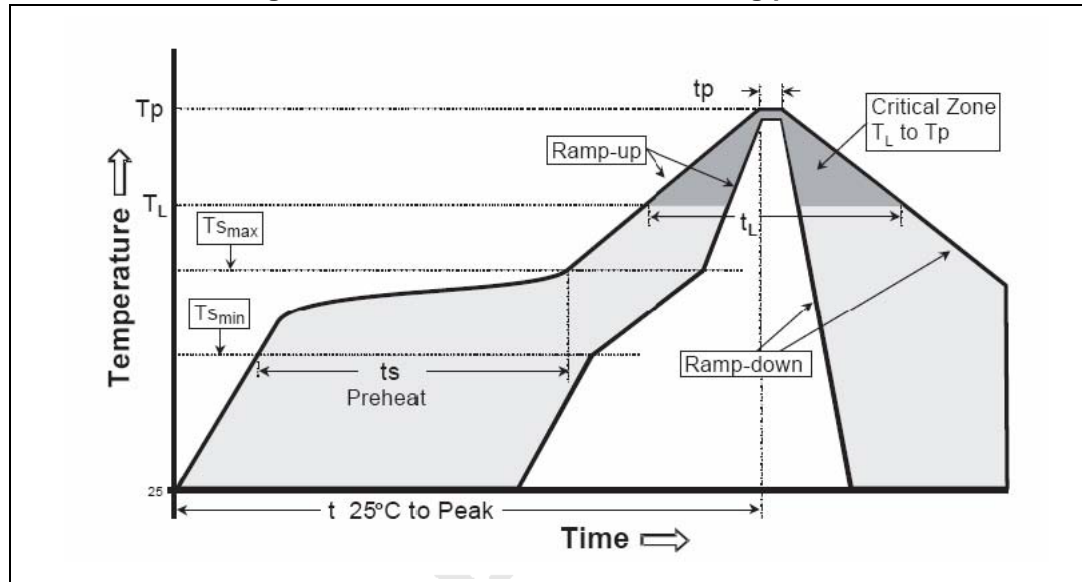

**Table 3. JEDEC standard Lead-free reflow profile (according to J-STD-020D) <sup>(1)</sup>**

Profile feature	Lead-free assembly
Average ramp-up rate ( $T_{smax}$ to $T_P$ )	3 °C/second max.
Preheat	
– Temperature Min ( $T_{smin}$ )	150 °C
– Temperature Max ( $T_{smax}$ )	200 °C
– Time ( $t_S$ )	60-120 seconds
Time maintained above:	
– Temperature ( $T_L$ )	217°C
– Time ( $t_L$ )	60-150 seconds
Peak/classification temperature ( $T_P$ )	Package dependent, see temperature indicated on box label.
Time within 5 °C of actual peak temperature ( $T_P$ )	30 seconds
Ramp-down rate	6°C/second max.
Time 25 °C to peak temperature	8 minutes max.

1. All temperatures refer to topside of the package, measured on the body surface.

## 5 SMD gluability

It is strongly recommended to follow glue application specifications from their glue supplier, and to use 100% glue polymerization for optimal glue efficiency.

**Figure 4. Recommended profiles for glue polymerization using regular oven and linear flow oven**

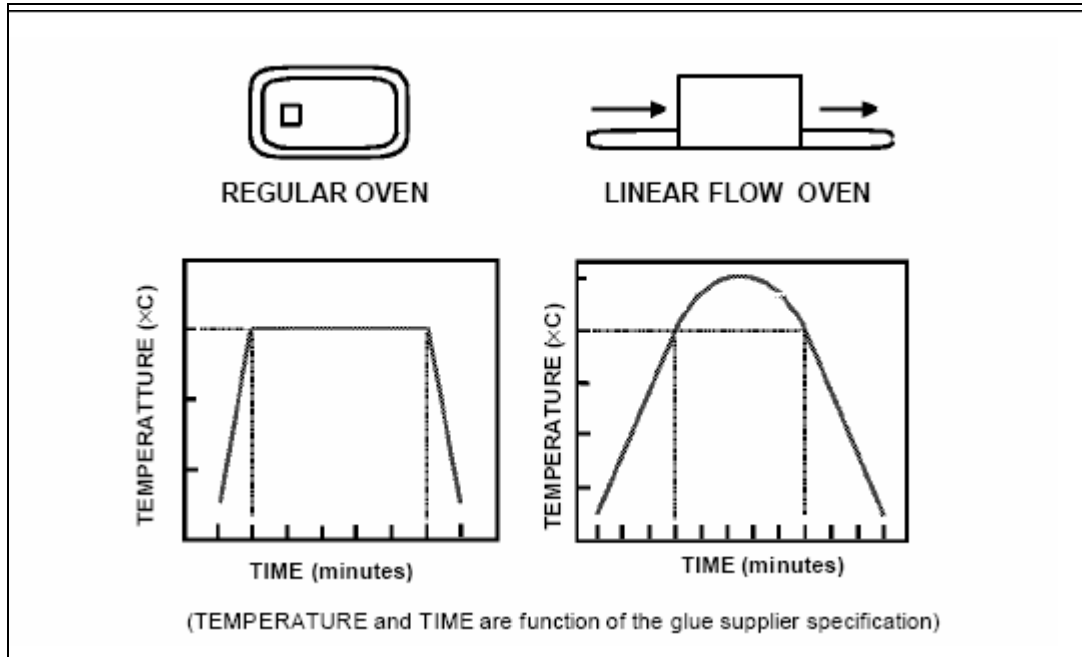

**Figure 5. Gluability evaluation with a shear test**

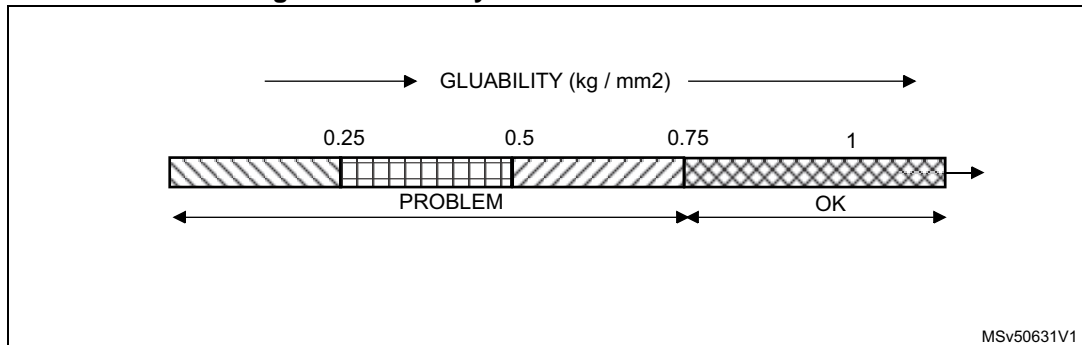

Various tests have shown that glue shear test specification limit conforms to the IPC SM817 standard (0.75 kg/mm<sup>2</sup> minimum). Customer complaints usually happen when values are below 0.5 kg/mm<sup>2</sup>. It has been verified that below 0.25 kg/mm<sup>2</sup> components fall from PCB during handling. General capability in plastic SMD is greater than 1 kg/mm<sup>2</sup>.

## 6 Dry packing

Quality and reliability of SMDs after soldering depends heavily on moisture absorption during storage. A specific packing, called dry pack, was implemented for defined conditions at the delivery. Time and environment will modify the amount of absorbed humidity. Moisture sensitive SMDs (SOP, PLCC, PQFP, BGA, VFQFPN, UFQFPN, and WLCSP) are dry packed to protect them from moisture absorption during shipment / storage and then to reduce failure risks mainly due to popcorn effect.

### 6.1 Pop-corn effect

Pop-corn effect is the cracking of the package during the soldering cycle. It has got a growing importance due to the trends towards larger die size in integrated circuits. This phenomenon is mainly caused by the moisture absorbed by the epoxy molding. When the package is exposed to high temperatures, as in most SMT soldering processes, the water at the interface between plastic and die pad vaporizes suddenly, generating high internal pressure. Cracks may occur in the molding compound depending on the absorbed moisture level, soldering temperature and time, die size, package structure and molding compound characteristics.

SMD products are contained in tubes, on trays or on tape, and are then vacuum sealed in an hermetic bag.

Opening the package will stop the ideal conditions and start the influence of the normal environment. [Figure 6](#) shows the recommended handling flow.

Figure 6. Recommended flow to control package moisture absorption

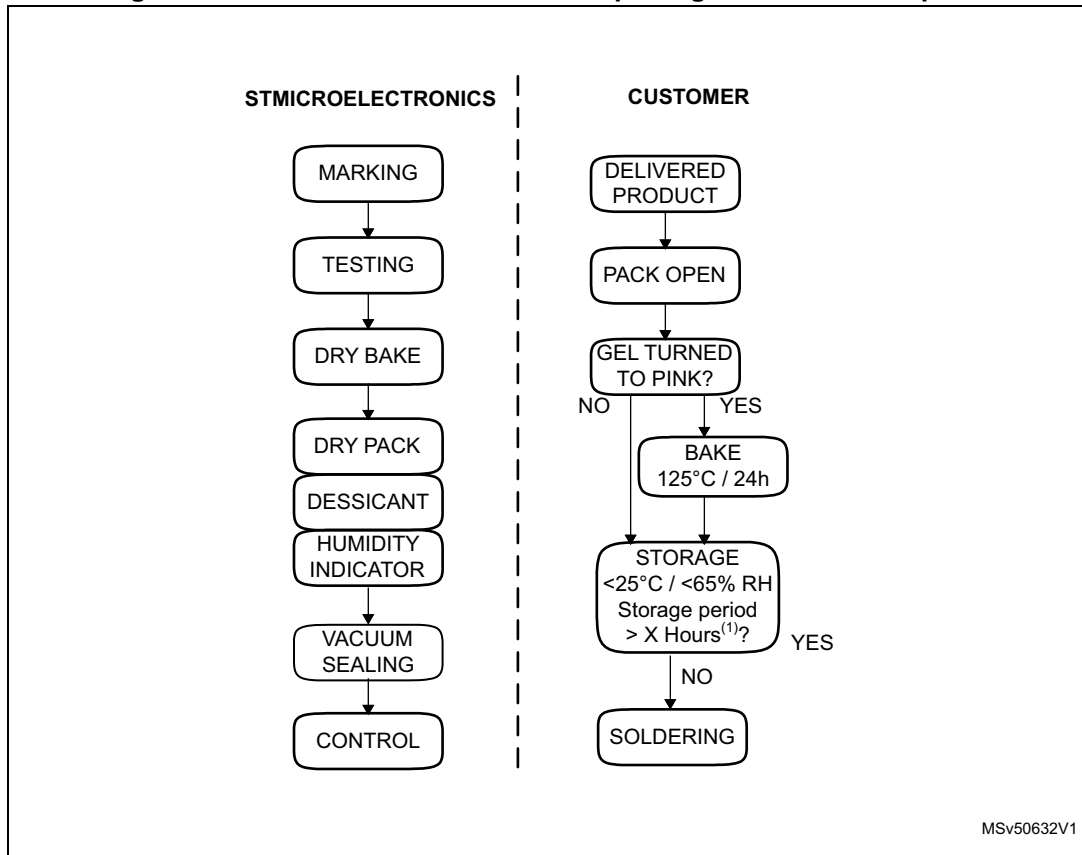

MSv50632V1

1. X depends on the MSL level (see JEDEC standard J-STD-020D).

Parts in dry pack are recommended to be stored in dry boxes (i.e. cabinets under nitrogen atmosphere). See [Table 4](#) for the recommended environmental conditions for storage when no dry boxes are available.

Table 4. Environmental conditions

Condition	Recommended value
Temperature	5 -> 30°C
Humidity	60% RH max

Dust should also be minimized. There should be no vibration or shock which could distort the packing container. To avoid excess weight packing, containers should not be stacked on top of each other.

## 6.2 Dry pack opening

After opening a dry pack, soldering should be done within 24 hours. SMD products stored over the specified storage period need to be baked at 125 °C for 24 hours (under nitrogen atmosphere). Devices packed in tubes or in tapes must be transferred to metal tubes before baking whereas trays are bake able.

Figure 7. Moisture absorption / drying curve

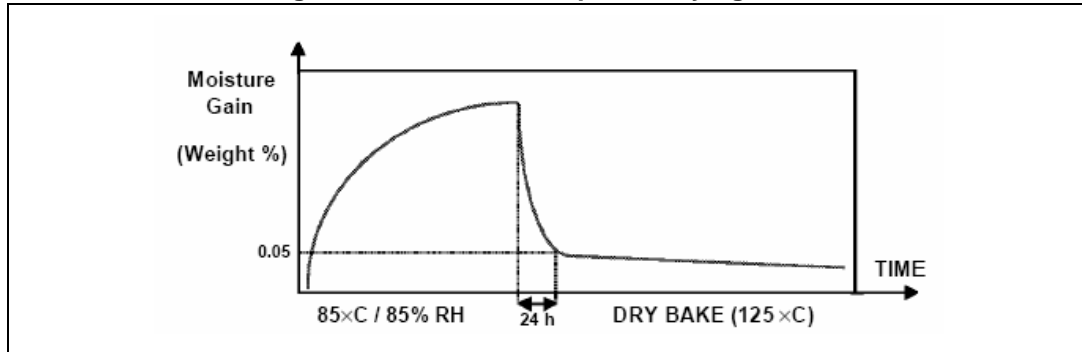

## 7 Revision history

**Table 5. Document revision history**

Date	Revision	Changes
16-Oct-2007	1	Initial release
26-May-2009	2	Modified $t_L$ and $t_P$ in <a href="#">Table 3: JEDEC standard Lead-free reflow profile (according to J-STD-020D)</a> . Updated <a href="#">Figure 6: Recommended flow to control package moisture absorption</a> .
22-May-2013	3	Updated <a href="#">Table 1: Package types</a> and <a href="#">Table 2: Package/soldering process compatibility</a> . Added UFQFPN and WLCSP packages in <a href="#">Section 6: Dry packing</a> . Document converted to new template and disclaimer updated.
07-Jul-2014	4	Updated RoHS directive and related note in <a href="#">Section 1: Lead-free packages at STMicroelectronics</a> .
17-May-2016	5	Updated maximum temperature during soldering in <a href="#">Section 2: Packages overview</a> . Removed reference to application note AN2034 in <a href="#">Section 4.3: Compatibility with leaded soldering process</a> . Updated humidity recommended value unit in <a href="#">Table 4: Environmental conditions</a> .
27-Mar-2018	6	<a href="#">Table 2: Package/soldering process compatibility</a> : – updated note 2. – changed process for QFP packages
10-Oct-2019	7	Updated <a href="#">Introduction</a> , title of <a href="#">Section 2: Packages overview</a> , <a href="#">Table 1: Package types</a> , <a href="#">Table 3: JEDEC standard Lead-free reflow profile (according to J-STD-020D)</a>

**IMPORTANT NOTICE – PLEASE READ CAREFULLY**

STMicroelectronics NV and its subsidiaries ("ST") reserve the right to make changes, corrections, enhancements, modifications, and improvements to ST products and/or to this document at any time without notice. Purchasers should obtain the latest relevant information on ST products before placing orders. ST products are sold pursuant to ST's terms and conditions of sale in place at the time of order acknowledgement.

Purchasers are solely responsible for the choice, selection, and use of ST products and ST assumes no liability for application assistance or the design of Purchasers' products.

No license, express or implied, to any intellectual property right is granted by ST herein.

Resale of ST products with provisions different from the information set forth herein shall void any warranty granted by ST for such product.

ST and the ST logo are trademarks of ST. For additional information about ST trademarks, please refer to [www.st.com/trademarks](http://www.st.com/trademarks). All other product or service names are the property of their respective owners.

Information in this document supersedes and replaces information previously supplied in any prior versions of this document.

© 2019