



LC filters for mobile phone LCD and camera links

Introduction

The mobile phone is a compact, small device, which radiates high power, and needs to have a very good sensitivity for signal reception. This functional conflict generates an EMI issue, which can be addressed by filtering.

1 EMI issue on the mobile phone

The baseband part of the mobile phone can be either the object or the source of EMI.

A mobile phone can generate a power up to 2 W in the GSM band. This radiation can impact external wires, such as the hands-free kit, or USB cable. This can generate TDMA noise on the audio part, but also errors on the USB link. In this case the mobile phone is the object of EMI, as shown on [Figure 1](#).

Figure 1. Baseband is a victim of EMI

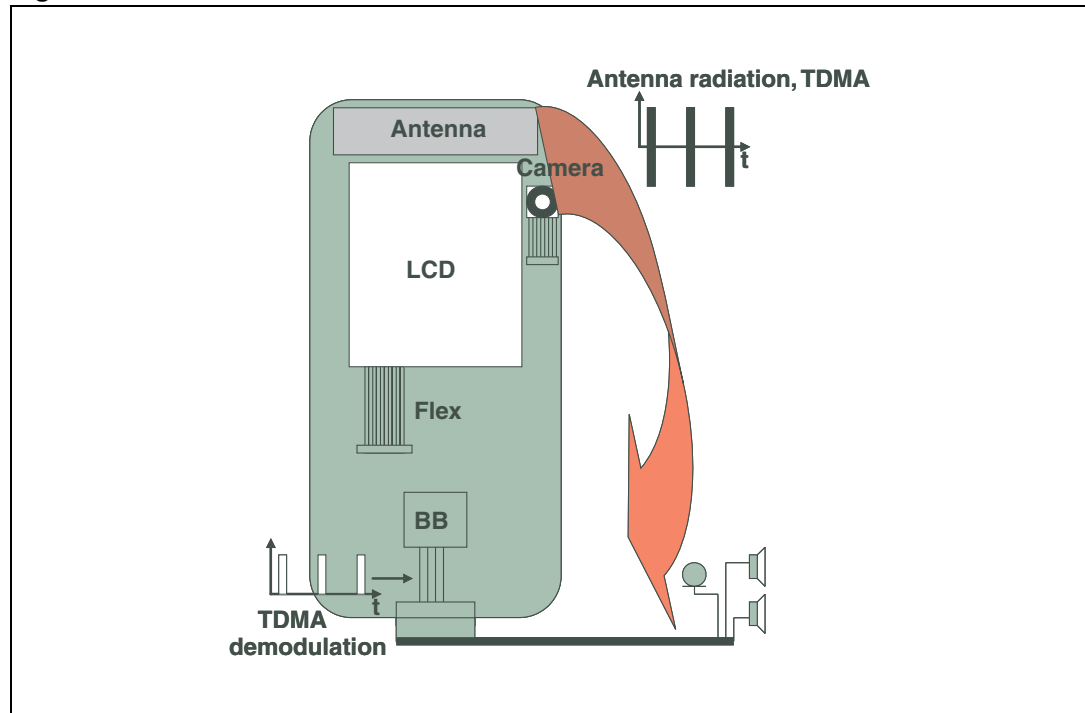

The mobile phone can be also a source of EMI, regarding the RF part.

The sensitivity of a mobile phone needs to be very good, especially concerning communications far from the base station. According to TS125101 and TS100910 standards, sensitivity must be as low as -104 dBm in GSM mode and -107 dBm in W-CDMA. These sensitivities can be achieved by a radio system, but it needs to be free of external noise.

As the digital signal spectrum is wide-band, harmonics can occur at the same frequency as the receiving frequency. Radiation at these frequencies, by a flex for example, can impact the antenna, producing noise at the LNA input.

[Figure 2](#) presents a case where the base station (BST) signal received by the antenna is lower than the flex radiation. The base station signal is below the noise floor, and cannot be used by the mobile phone. Only a BST signal higher than noise floor can be received. Mobile phone sensitivity is thus defined by the flex radiation noise, and not by the RF system performance.

Figure 2. Baseband is a source of EMI, which reduces the mobile's sensitivity

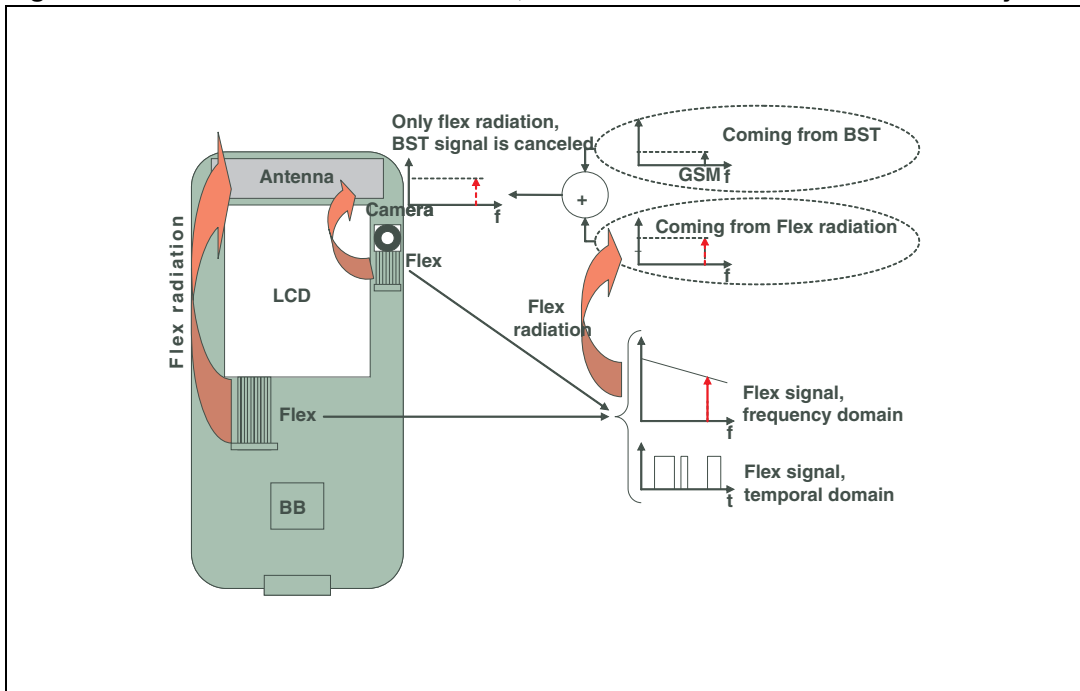

To keep the mobile phone sensitivity at the radio level, the radiated digital signal needs to be filtered.

2 Link between baseband processor and LCD or camera

One of the noisy digital links is the LCD or camera bus. The trends for LCD size and camera resolution are both increasing, thus requiring the transmission of greater and greater volumes of data. These trends result in clock frequencies which are now in the range of 10-50 MHz. Harmonics are at the same frequencies as the GSM reception band. Baseband processor are also getting faster and faster, inducing very low rise and fall times, making the digital signal spectrum wide band.

In a mobile phone, these links use a Flex PCB several centimeters long, which acts as an antenna.

Consequently, combining all these parameters, digital links can drastically reduce the sensitivity of a mobile phone.

Figure 3 shows the signal waveform measured on an LCD link.

Figure 3. Signal to control the LCD

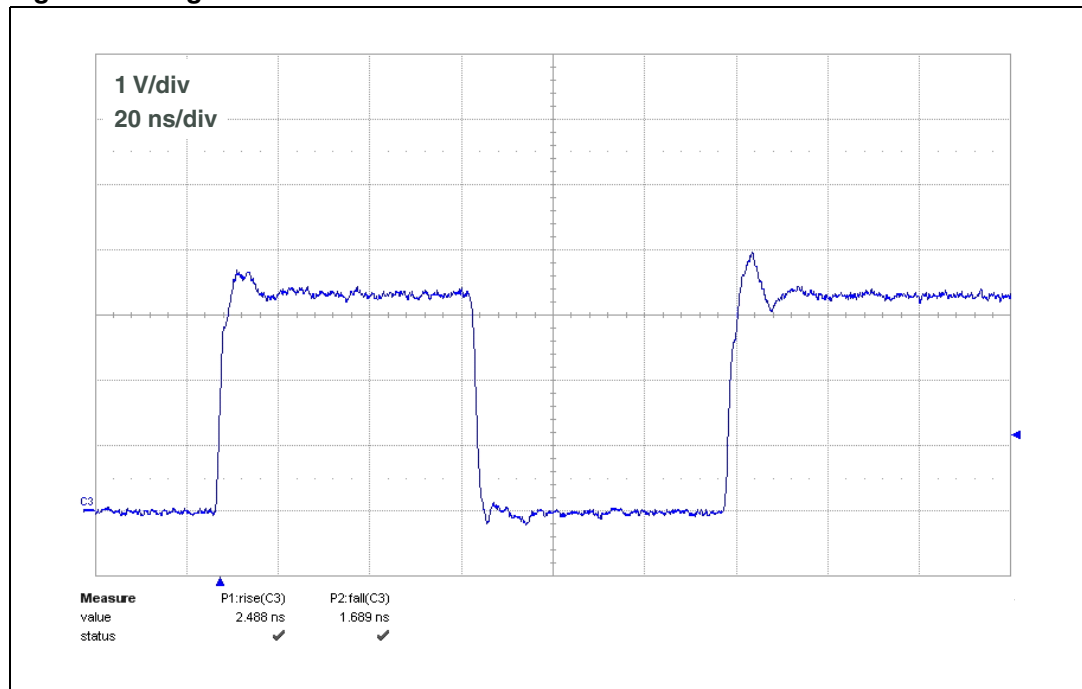

This signal has rise and fall time in the range of 2 ns. These edges will radiate electromagnetic fields in the in the range of RX mobile phone frequencies.

To evaluate the spectrum generated by this waveform, a measurement has been done on the similar signal, with a spectrum analyzer:

- Signal amplitude: 3 V
- Signal frequency: 20 MHz
- Modulation: PRBS 2n-1
- Rise and fall time: 1.8 ns

We choose to perform a measurement at 940 MHz, which is near the middle of the GSM RX band.

The measurement setup is presented in *Figure 4*. Due to the spectrum content of a digital signal, band-pass filter is needed to avoid saturation of the spectrum analyzer input stage.

Figure 4. Harmonic measurement test setup

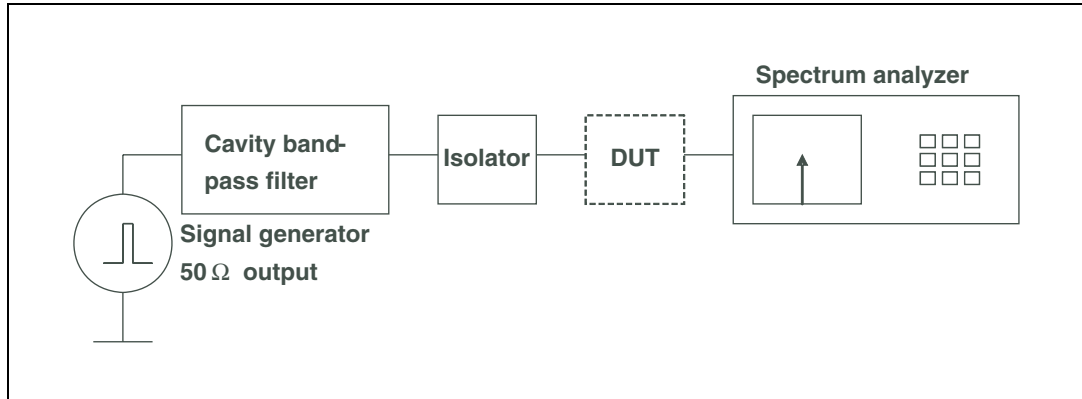

Measurement results is shown in *Figure 5* (DUT short-circuited).

Figure 5. Spectrum at 940 MHz of a 1.8 ns rise/fall time, 20 MHz signal

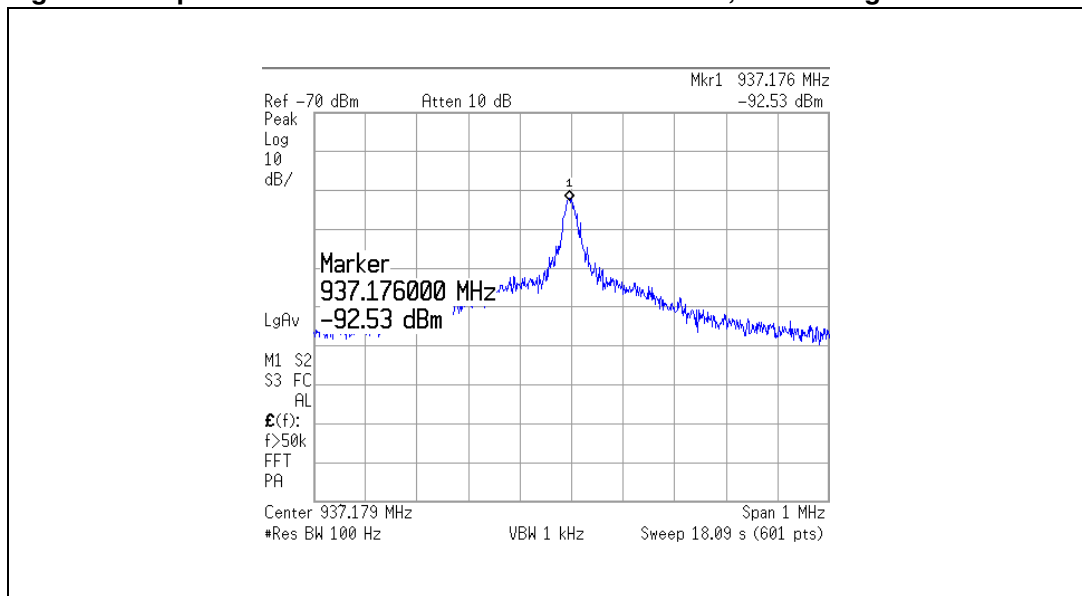

The result shows that the emission of this signal is significant regarding the required sensitivity of a mobile phone.

This measurement was performed on one line, while digital links integrate several lines in parallel. In addition, measurements have been performed on 50 environment, which is not the case in the application (link is not impedance matched, drivers are low impedance and receiver high impedance). Consequently, radiated field can be very high.

Without any filtering, this signal can drastically decrease the sensitivity of a mobile phone.

3 Filtering the LCD or camera link

The filter choice is made according two parameters:

- Bandwidth, to keep the signal integrity in case of digital signals
- Rejection at the frequency to attenuate, i.e. at RX frequencies of mobile phone

LCD and camera link clock frequency is in the range of 10 - 50 MHz, and the digital signal is a wide band spectrum signal. Consequently, bandwidth of the filter needs to be in the range of 200 MHz to keep good signal integrity.

As shown before (see [Figure 2](#)), the filter must reject the mobile phone reception frequencies: GSM to W-CDMA gives frequencies from 869 MHz to 2.17 GHz.

In this frequency range attenuation needs to be as high as possible to limit the emissions of the digital link.

Three types of device have been developed by STMicroelectronics to ensure good signal integrity:

- EMIF10-LCD02F3, 10-line version, (or EMIF07-LCD02F3, 7-line version)
- EMIF08-LCD04M16,
- EMIF10-LCD03F3 (or EMIF07-LCD03F3)

These devices offer a bandwidth of 200 MHz, as shown in [Figure 6](#), [Figure 7](#) and [Figure 8](#).

Attenuation at RX frequencies are not the same:

- EMIFxx-LCD02F3 is an RC type filter and provides attenuation of -25 dB at 900 MHz.
- EMIF08-LCD04M16 is an LC filter and provides attenuation of -35 dB at least on RX band, which is better than the RC type filter.
- EMIFxx-LCD03F3 is an LC type filter and provides attenuation of -50 dB on RX band - better than the RC type filter.

Figure 6. Frequency response of EMIF10-LCD02F3, RC type

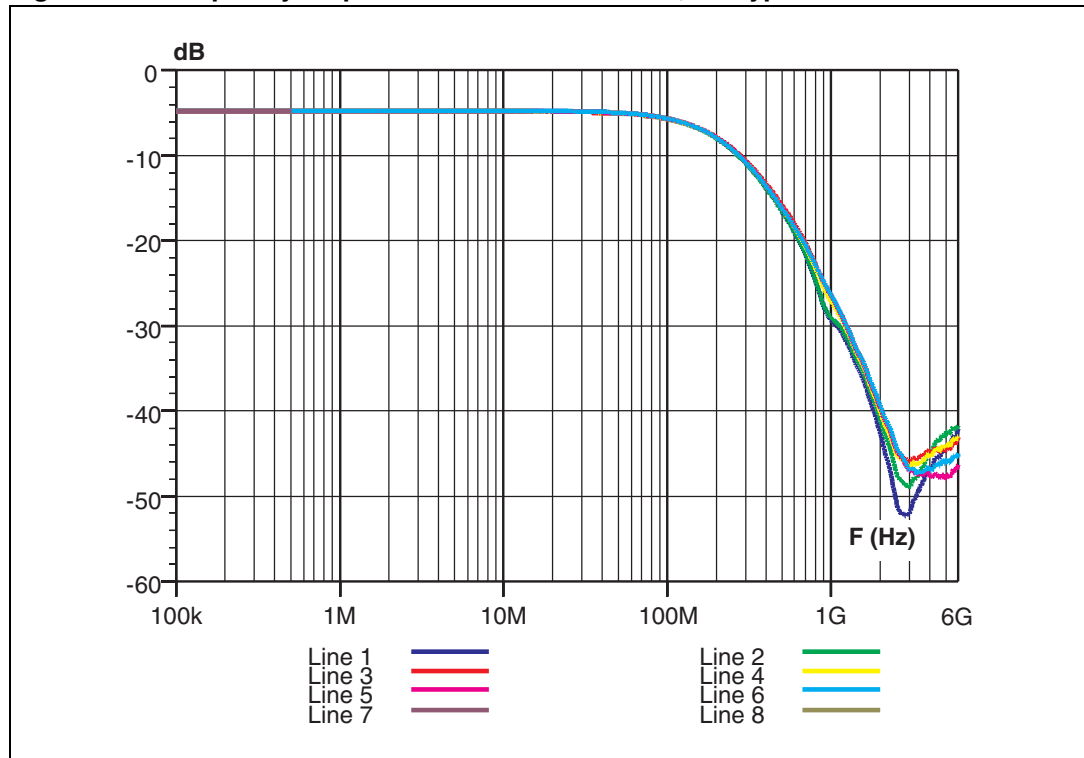

Figure 7. Frequency response of EMIF08-LCD04M16, LC type

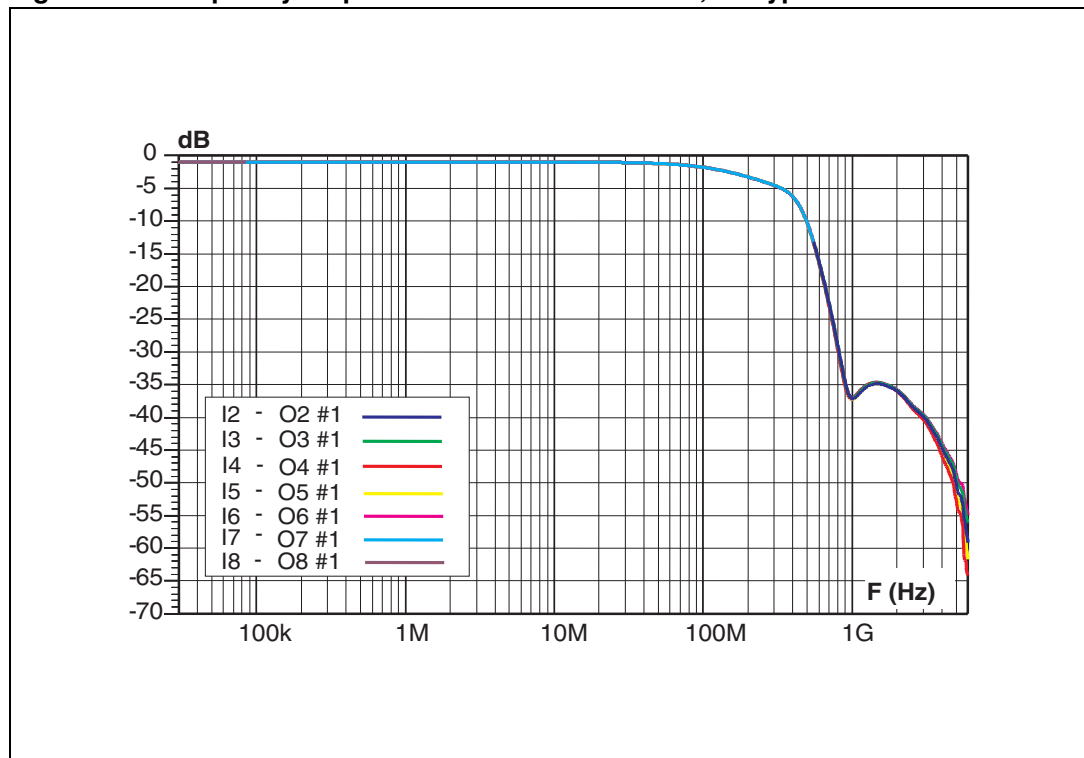
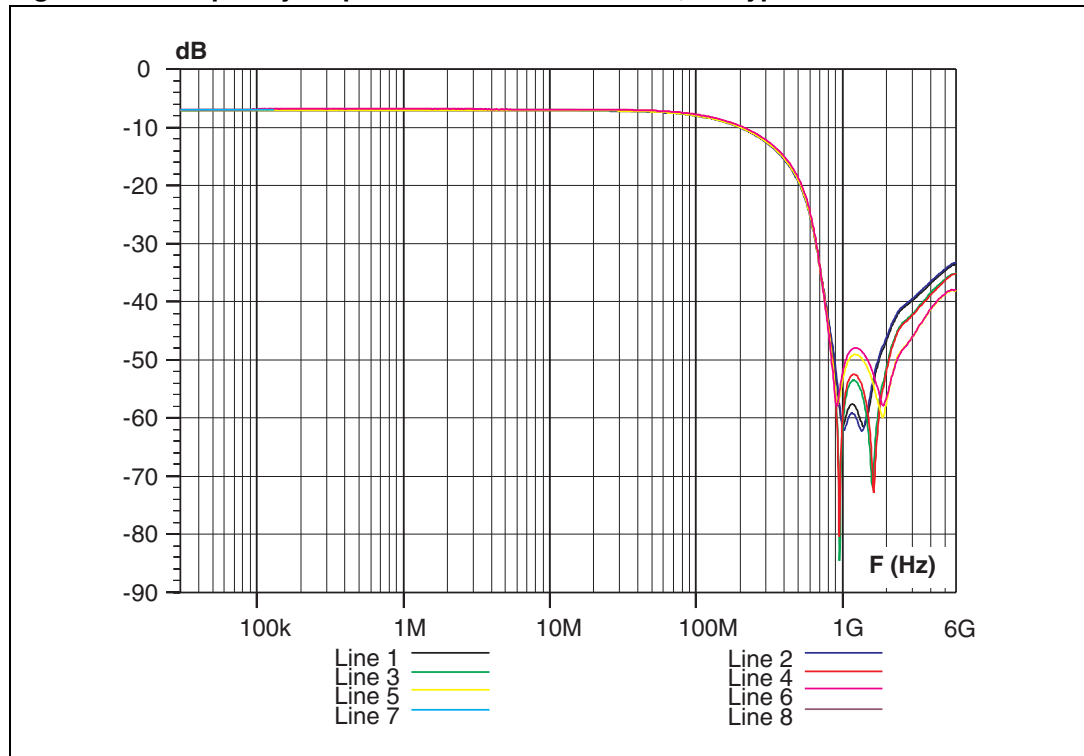
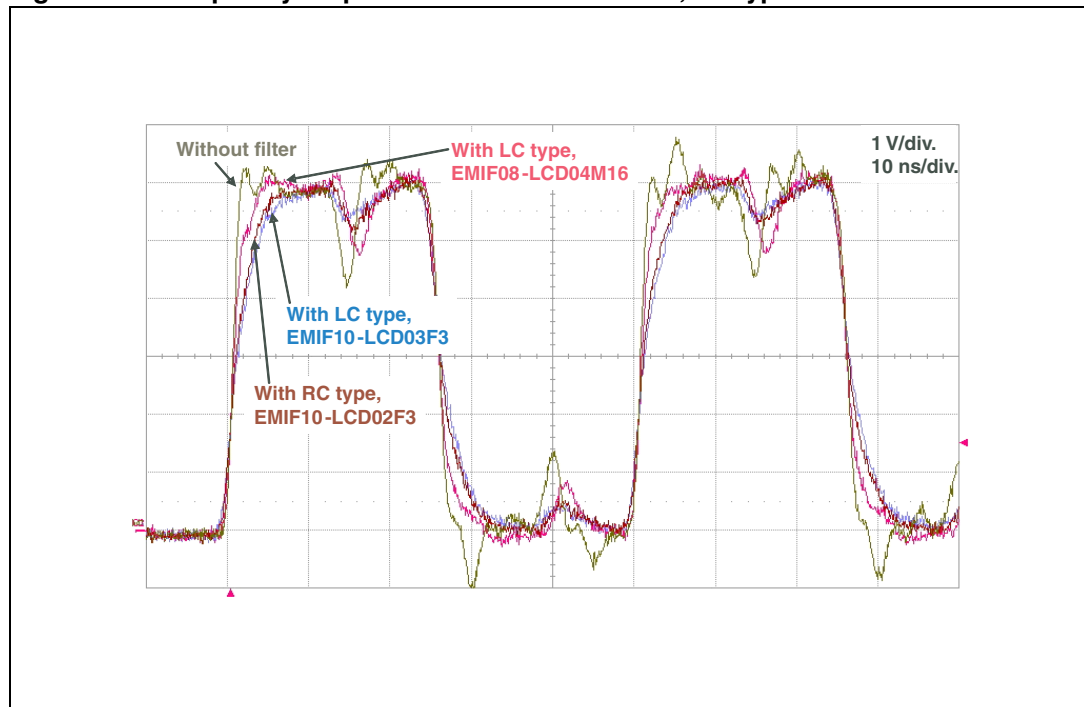

Figure 8. Frequency response of EMIF10-LCD03F3, LC type



All filters have a high bandwidth so they have a very small impact on the signal in the time domain, as shown on the [Figure 9](#).

Figure 9. Frequency response of EMIF10-LCD03F3, LC type



The same measurements have been performed in the frequency domain, at 940 MHz. [Figure 10](#), [Figure 11](#), and [Figure 12](#) show the harmonic power with RC and LC type filter.

Figure 10. Spectrum at 940 MHz, with RC type filter, EMIF10-LCD02F3

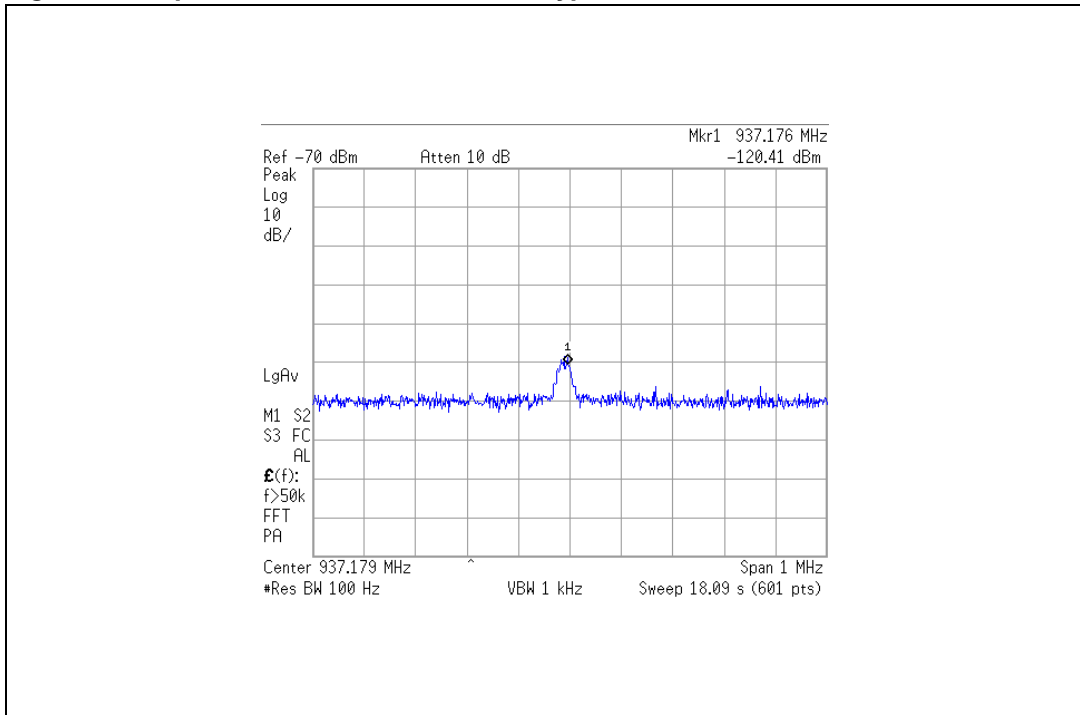

Figure 11. Spectrum at 940 MHz, with LC type filter, EMIF08-LCD04M16

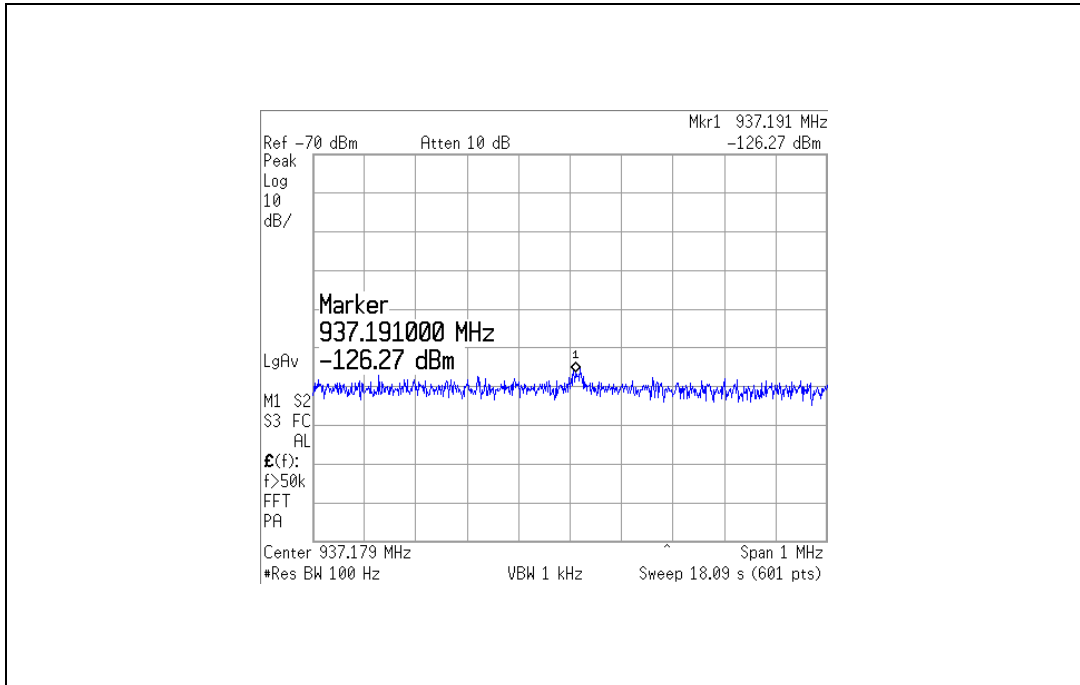
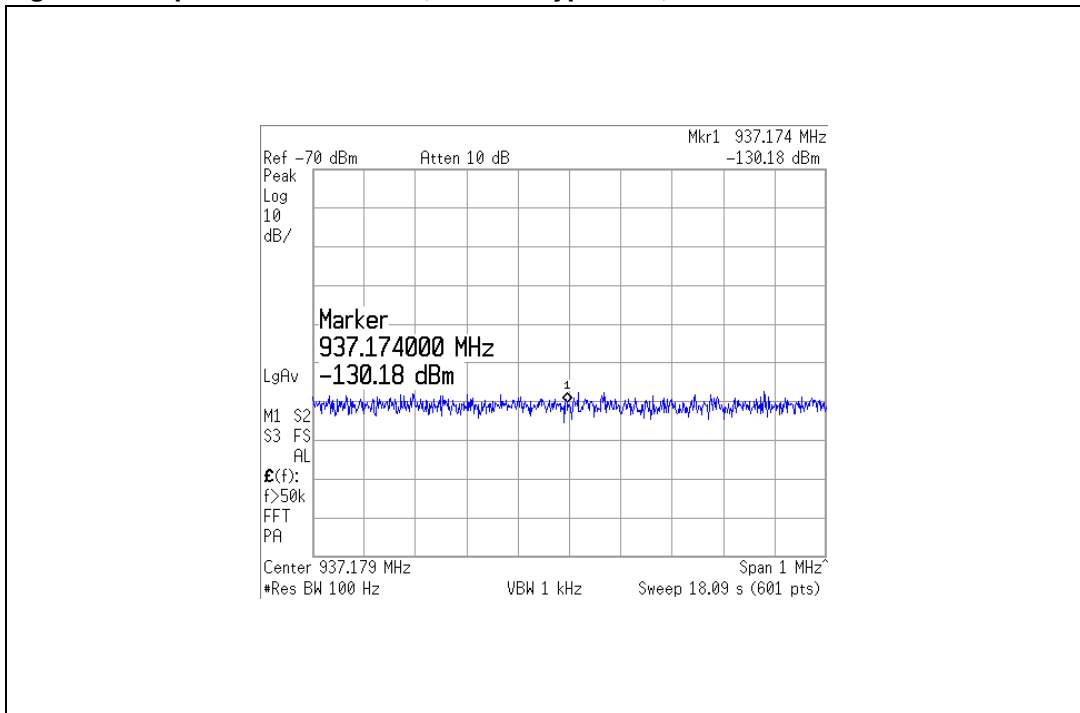

Figure 12. Spectrum at 940 MHz, with LC type filter, EMIF10-LCD03F3



Power at 940 MHz, without filter was -92.5 dBm (see [Figure 5](#)):

- With EMIF10-LCD02F3, RC type filter, the power is decreased to -120 dBm.
- With EMIF08-LCD04M16, LC type filter, the power is decreased to -126 dBm.
- With EMIF10-LCD03F3, LC type filter, the power becomes insignificant, as it is lower than the -130 dBm, which is the noise floor of the measurement system.

This shows that the use of a filter decreased the harmonic levels of the LCD and camera links.

An LC type filter, such as the EMIF08-LCD04M16 or EMIF10-LCD03F3, ensures the best filtering, because harmonic power is insignificant, while maintaining good signal integrity.

4 Filter placement

The goal of filters is to avoid flex radiation at mobile phone reception frequencies. Consequently, filters need to be placed just before the flex connector, at the digital signal generator side.

For implementation on the LCD link, filters should be placed on the main PCB, between baseband processor and the flex connector. By contrast, for the camera link, filters will be placed on the camera PCB, as the signal comes from the camera to go to the baseband processor. In case of a bidirectional link, both sides of the flex need to be filtered.

Figure 13 show filter placement for LCD and camera links.

Figure 13. Filters placement on LCD and camera links

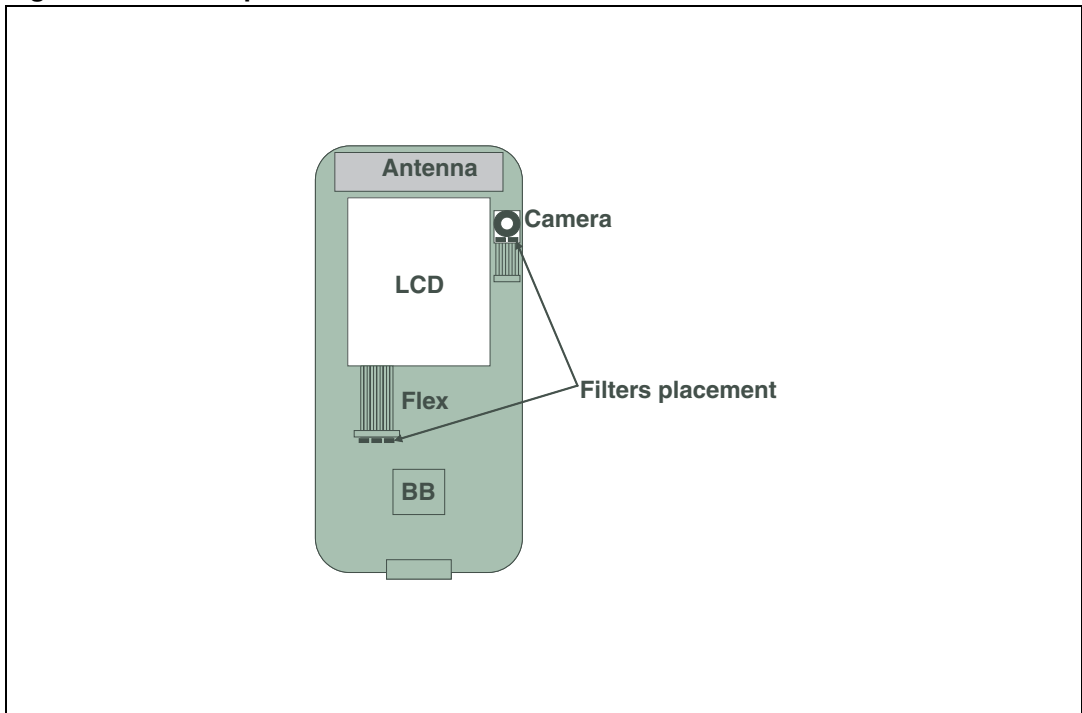

5 Conclusion

Mobile phone LCD or camera links can radiate on the RX frequencies, which can impact mobile phone sensitivity.

To evaluate this radiation, a spectrum measurement has been performed at RX GSM frequencies, on a digital signal having 1.8 ns rise and fall time. The measurement identifies a power of -92 dBm at 940 MHz, on a single line, and 50 Ω environment. This is huge regarding the requested sensitivity on GSM band.

To reduce this noise, filtering is needed. It must respect the signal integrity, and filter RX band frequencies.

EMIF08-LCD04M16, EMIFxx-LCD02F3 and EMIFxx-LCD03F3 have been designed to filter parallel LCD and camera links, while fully respecting signal integrity. Time domain measurement shows a very low impact on the signal.

Frequency domain measurements with filters show attenuation at RX band frequencies:

- From -92 dBm without filter to -120 dBm with EMIF10-LCD02F3, RC type filter, at F=940 MHz
- From -92 dBm without filter to -126 dBm with EMIF08-LCD04M16, LC type filter, at F=940 MHz
- From -92 dBm without filter to a power lower than -130 dBm with EMIF10-LCD03F3, LC type filter, at F=940 MHz

Consequently, using filters, before the flex connection, reduces the emission of the flex at RX frequencies.

Using LC type filters:

- Does not impact the signal integrity
- Decreased the reception frequency range power to an insignificant value

Consequently, the RF system sensitivity is not affected. It remains at its own value.

6 Revision history

Table 1. Document revision history

Date	Revision	Changes
16-Sep-2010	1	Initial release.

Please Read Carefully:

Information in this document is provided solely in connection with ST products. STMicroelectronics NV and its subsidiaries ("ST") reserve the right to make changes, corrections, modifications or improvements, to this document, and the products and services described herein at any time, without notice.

All ST products are sold pursuant to ST's terms and conditions of sale.

Purchasers are solely responsible for the choice, selection and use of the ST products and services described herein, and ST assumes no liability whatsoever relating to the choice, selection or use of the ST products and services described herein.

No license, express or implied, by estoppel or otherwise, to any intellectual property rights is granted under this document. If any part of this document refers to any third party products or services it shall not be deemed a license grant by ST for the use of such third party products or services, or any intellectual property contained therein or considered as a warranty covering the use in any manner whatsoever of such third party products or services or any intellectual property contained therein.

UNLESS OTHERWISE SET FORTH IN ST'S TERMS AND CONDITIONS OF SALE ST DISCLAIMS ANY EXPRESS OR IMPLIED WARRANTY WITH RESPECT TO THE USE AND/OR SALE OF ST PRODUCTS INCLUDING WITHOUT LIMITATION IMPLIED WARRANTIES OF MERCHANTABILITY, FITNESS FOR A PARTICULAR PURPOSE (AND THEIR EQUIVALENTS UNDER THE LAWS OF ANY JURISDICTION), OR INFRINGEMENT OF ANY PATENT, COPYRIGHT OR OTHER INTELLECTUAL PROPERTY RIGHT.

UNLESS EXPRESSLY APPROVED IN WRITING BY AN AUTHORIZED ST REPRESENTATIVE, ST PRODUCTS ARE NOT RECOMMENDED, AUTHORIZED OR WARRANTED FOR USE IN MILITARY, AIR CRAFT, SPACE, LIFE SAVING, OR LIFE SUSTAINING APPLICATIONS, NOR IN PRODUCTS OR SYSTEMS WHERE FAILURE OR MALFUNCTION MAY RESULT IN PERSONAL INJURY, DEATH, OR SEVERE PROPERTY OR ENVIRONMENTAL DAMAGE. ST PRODUCTS WHICH ARE NOT SPECIFIED AS "AUTOMOTIVE GRADE" MAY ONLY BE USED IN AUTOMOTIVE APPLICATIONS AT USER'S OWN RISK.

Resale of ST products with provisions different from the statements and/or technical features set forth in this document shall immediately void any warranty granted by ST for the ST product or service described herein and shall not create or extend in any manner whatsoever, any liability of ST.

ST and the ST logo are trademarks or registered trademarks of ST in various countries.

Information in this document supersedes and replaces all information previously supplied.

The ST logo is a registered trademark of STMicroelectronics. All other names are the property of their respective owners.

© 2010 STMicroelectronics - All rights reserved

STMicroelectronics group of companies

Australia - Belgium - Brazil - Canada - China - Czech Republic - Finland - France - Germany - Hong Kong - India - Israel - Italy - Japan - Malaysia - Malta - Morocco - Philippines - Singapore - Spain - Sweden - Switzerland - United Kingdom - United States of America

www.st.com