

---

**STM32L4 and STM32L4+ ultra-low-power features overview**

---

## Introduction

Microcontrollers of the STM32L4 and STM32L4+ Series are based on Arm® Cortex®-M4 with FPU core. They use an innovative architecture to reach best-in-class, ultra-low power figures thanks to their high flexibility and advanced set of peripherals, and outperform the competition in the ultra-low-power world by providing the best energy efficiency for applications.

Thanks to the integration of the ART Accelerator™, the STM32L4/STM32L4+ Series can operate, respectively, at up to 80/120 MHz, and achieve 100/150 DMIPS performance at 80/120 MHz, while maintaining the smallest possible dynamic power consumption.

Both feature FlexPowerControl, which increases flexibility in power mode management while at the same time reducing the overall application consumption.

STM32L4xx devices embed a high number of smart, high performing peripherals, a large set of advanced and low-power analog features, and several peripherals tuned for low-power modes. Thanks to the batch acquisition sub-mode (BAM), these microcontrollers optimize the consumption when data are transferred through communication peripherals, while the rest of the device is kept in low-power mode.

The combination of low-power design and processing performance allows these devices to achieve an industry leading EEMBC® ULPBench™ score, up to 176.7 for standard products, and up to 253 for the SMPS version.

Based on the solid foundations of the STM32F and STM32L families, the STM32L4 and STM32L4+ Series embed several innovations which minimize the consumption in the different modes, while maintaining most of the existing peripherals and an excellent pin-to-pin compatibility to allow an easy migration from existing families.

Thanks to their built-in internal voltage regulator and voltage scaling, the consumption in active modes is kept at a minimum whatever the external supply voltage. This makes these devices particularly suited for portable battery-supplied products, down to 1.71 V.

In addition, their multi-voltage domains allow the product to be supplied at low voltage (thus reducing consumption) while the analog-to-digital and digital-to-analog converters can operate with a higher supply and reference voltage, up to 3.6 V.

STM32L4xx microcontrollers support a battery backup domain to keep the RTC running, and a set of 32 registers, each 32-bit wide, that can be retained in case of power loss. This optional backup battery can be charged when the main supply is present.

STM32L4xx devices support seven main low-power modes, each of them with several submodes options. This allows the designer to achieve the best compromise between low-power consumption figure, shorter startup time, available set of peripherals and maximum number of wake-up sources.

STM32L4 devices with P suffix (STM32L4xxxxxxP) support the use of an optional external SMPS, thus enabling the design of very efficient and low power applications.

# Contents

- 1 Energy-efficient processing . . . . . 5**
- 2 FlexPowerControl description . . . . . 12**
  - 2.1 Numerous low-power modes . . . . . 12
    - 2.1.1 Low-power run and Low-power sleep modes . . . . . 12
    - 2.1.2 Stop mode . . . . . 13
    - 2.1.3 Standby mode . . . . . 13
    - 2.1.4 Shutdown mode . . . . . 13
  - 2.2 Multi-supply and battery backup domain . . . . . 16
  - 2.3 Ultra-safe supply monitoring . . . . . 18
  - 2.4 A set of peripherals tailored for low power . . . . . 19
  - 2.5 A versatile clock management . . . . . 25
- 3 Conclusion . . . . . 28**
- 4 Revision history . . . . . 29**

## List of tables

Table 1.	STM32L476 performance with system clock at 80 MHz. . . . .	8
Table 2.	Performance comparison (mA/MHz) with system clock at 80 MHz . . . . .	8
Table 3.	STM32L476 performance for different Run modes . . . . .	8
Table 4.	Performance comparison (mA/MHz) for different Run modes . . . . .	9
Table 5.	Number of wait states vs. CPU clock (HCLK) frequency, STM32L4+ Series . . . . .	11
Table 6.	STM32L4 modes overview . . . . .	14
Table 7.	Features over all modes . . . . .	21
Table 8.	STM32L4xx clock source characteristics . . . . .	25
Table 9.	Document revision history . . . . .	29

## List of figures

Figure 1.	STM32L476 - Current consumption vs. system frequency (25 °C) . . . . .	6
Figure 2.	Power distribution architecture . . . . .	6
Figure 3.	STM32L476 - Current consumption for different memory configurations . . . . .	7
Figure 4.	Flash memory latency vs. VCORE range, STM32L4 Series . . . . .	10
Figure 5.	Flash memory latency vs. VCORE range, STM32L4+ Series . . . . .	11
Figure 6.	Low-power modes possible transitions . . . . .	16
Figure 7.	Power supply overview . . . . .	18

# 1 Energy-efficient processing

The STM32L4 and STM32L4+ Series are built around an Arm® Cortex®-M4 with FPU and DSP instruction set<sup>(a)</sup>.



The high processing performance in Run mode (expressed in DMIPS/MHz) is achieved thanks to the use of a Cortex®-M4 core associated with the interfaces of its memories. To ensure full performance operation at maximum operating frequency these microcontrollers Series embed the ART Accelerator™, which masks the Flash memory access wait state, and makes it possible to achieve 1.25 DMIPS/MHz, whatever the system clock frequency.

The high energy efficiency, expressed as mA/DMIPS, is obtained by adapting dynamically the internal supply voltage to the operating frequency. This method is called “undervolting”.

STM32L4xx devices offer dynamically selectable voltages and frequency ranges:

1. Range 1 Boost for system frequency up to 120 MHz (STM32L4+ Series only)
2. Range 1 for system frequency up to 80 MHz
3. Range 2 for system frequency up to 26 MHz with improved efficiency (up to 15% higher than Range 1).

A dedicated Low-power run mode (LPRun) allows the core to execute at up to 2 MHz, with improved efficiency, up to 20% higher compared to Range 2.

This is achieved by supplying the logic with the internal low-power regulator. In this mode the peripherals with independent clock can still run on the internal high speed oscillator (HSI) at 16 MHz. Those peripherals are I2C, USART, LPUART1, LPTIM and SWPMI1.

---

a. Arm is a registered trademark of Arm Limited (or its subsidiaries) in the US and/or elsewhere.

Figure 1 shows the typical current consumption of a STM32L476, as a function of system frequency, using different run modes.

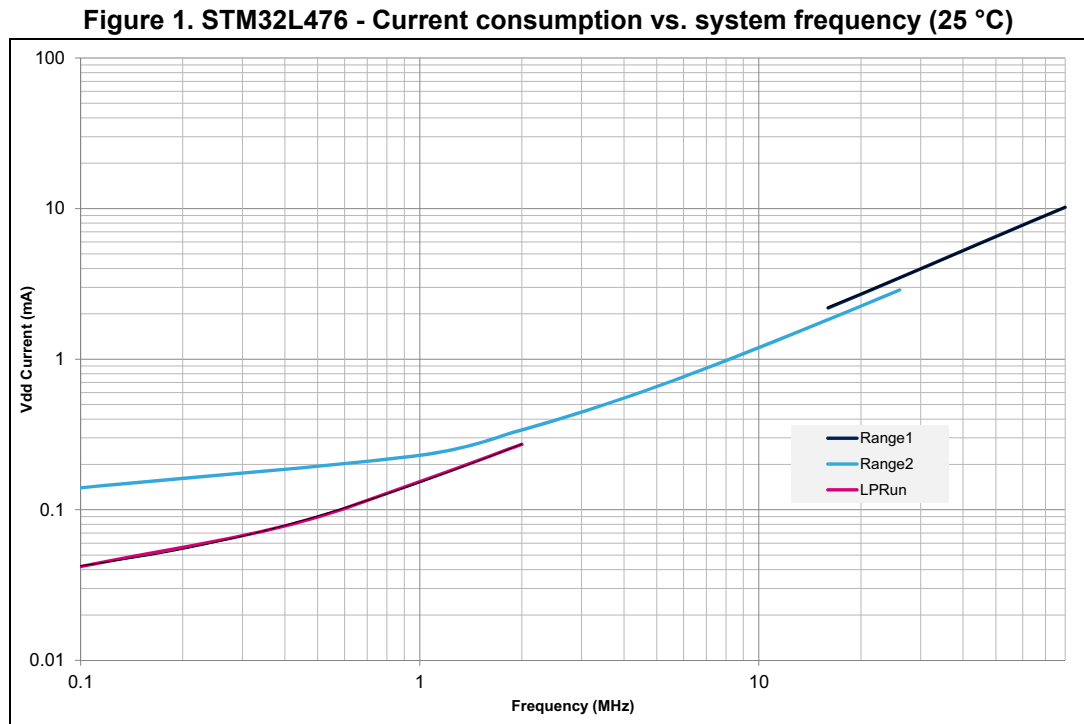
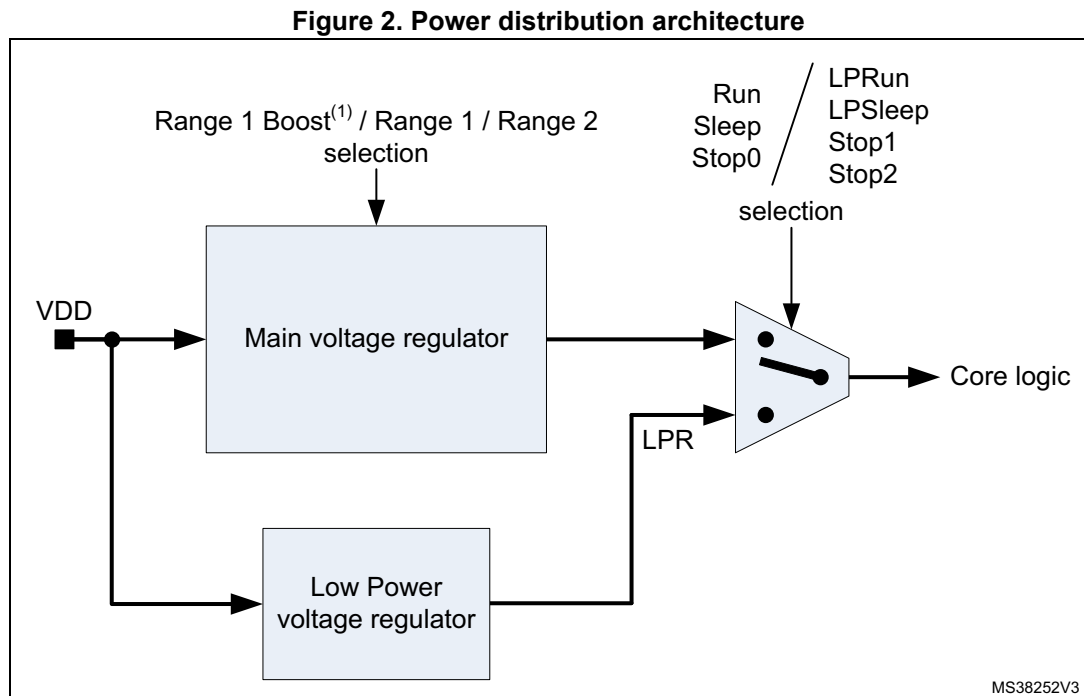

Figure 2 shows the power distribution from the internal LDO regulator in the different Run and Sleep modes.



1. When available.

STM32L4 and STM32L4+ microcontrollers enable to execute code either from the internal Flash memory, the SRAM1 and SRAM2, the external Quad-SPI/OctoSPI or FSMC Bank 1.

When running from internal SRAM the current consumption is the lowest. When running from the internal Flash memory the ART Accelerator™ tends to reduce the number of access to the memory thus reducing the overall current consumption.

Figure 3 shows the consumption of a STM32L476 for three main memory configurations:

- execution from the internal Flash memory, ART Accelerator™ disabled;
- execution from the internal Flash memory, ART Accelerator™ enabled;
- execution from the internal SRAM1, Flash memory disabled.

Figure 3. STM32L476 - Current consumption for different memory configurations

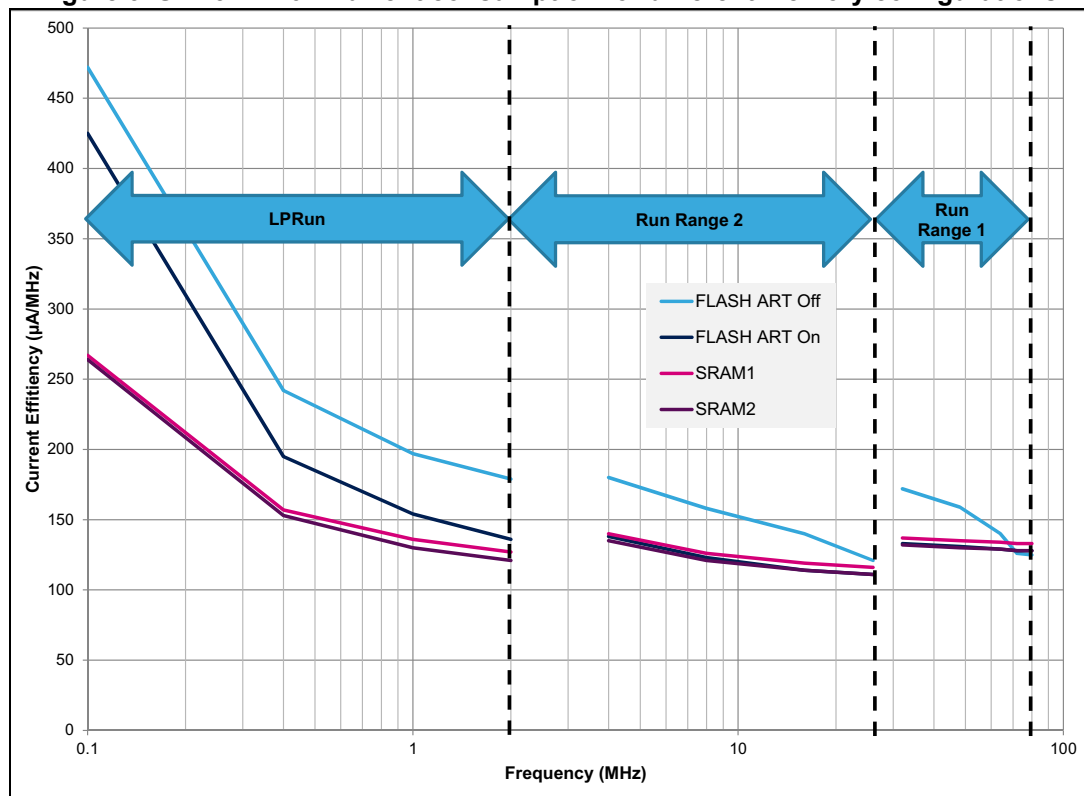

The location of the executable code and data within the memory system impacts not only the current consumption but also the overall computation performances. As an example, [Table 1](#) details the overall performances measured on a STM32L476 at 80 MHz system clock running a more complex algorithm, such as CoreMark<sup>®</sup> from EEMBC<sup>®</sup> organization.

**Table 1. STM32L476 performance with system clock at 80 MHz**

Configuration	mA/MHz	CoreMark <sup>®</sup> per MHz	CoreMark <sup>®</sup> per mA	Comments
FLASH ART Off	0.117	1.55	13.2	-
FLASH ART On	0.136	3.32	24.4	Cache On, Prefetch buffer Off
SRAM1	0.130	2.37	18.2	Code and Data in SRAM1
SRAM1 and SRAM2	0.137	3.42	25	Code in SRAM1 and Data in SRAM2

The performance of different products are compared in [Table 2](#).

**Table 2. Performance comparison (mA/MHz) with system clock at 80 MHz<sup>(1)</sup>**

Configuration	Products							Comments
	STM32 L47x/48x	STM32 L43x/44x	STM32 L45x/46x	STM32 L49x/4Ax	STM32 L4Rx/4Sx	STM32 L4P5xx/ L4Q5xx	STM32 L41x/ L42x	
FLASH ART Off	0.117	0.100	0.102	0.117	0.162	0.15625	0.087	-
FLASH ART On	0.136	0.121	0.118	0.133	0.156	0.15625	0.102	Cache On, Prefetch buffer Off
SRAM1	0.130	0.097	0.097	0.121	0.137	0.12375	0.088	Code and Data in SRAM1

1. All values are for single bank mode.

The ART Accelerator<sup>™</sup> makes it possible to reach almost the same performance, both in computation (CoreMark<sup>®</sup> per MHz) and current consumption (CoreMark<sup>®</sup> per mA), as if the same program is run from the internal SRAM.

[Table 3](#) gives the impact on performance, measured on a STM32L476 device, for different Run modes.

**Table 3. STM32L476 performance for different Run modes**

Run mode	Configuration	mA/MHz	CoreMark <sup>®</sup> per MHz	CoreMark <sup>®</sup> per mA
Range 1 (80 MHz)	FLASH ART Off	0.117	1.55	13.2
	FLASH ART On	0.136	3.32	24.4
Range 2 (26 MHz)	FLASH ART Off	0.111	1.85	16.6
	FLASH ART On	0.118	3.35	28.4



The performance of different products are compared in [Table 4](#).

**Table 4. Performance comparison (mA/MHz) for different Run modes<sup>(1)</sup>**

Run mode	Configuration	Products						
		STM32 L47x/48x	STM32 L43x/44x	STM32 L45x/46x	STM32 L49x/4Ax	STM32 L4Rx/L4Sx	STM32 L4P5xx/ L4Q5xx	STM32 L41x/ L42x
Range 1 boost (120 MHz)	FLASH ART Off	-	-	-	-	0.154	0.14167	-
	FLASH ART On	-	-	-	-	0.156	0.16250	-
Range 1 (80 MHz)	FLASH ART Off	0.117	0.100	0.102	0.117	0.162	0.15625	0.087
	FLASH ART On	0.136	0.121	0.118	0.133	0.156	0.15625	0.102
Range 2 (26 MHz)	FLASH ART Off	0.111	0.094	0.096	0.114	0.154	0.14423	0.083
	FLASH ART On	0.118	0.103	0.102	0.110	0.138	0.13077	0.088

1. All values are for single bank mode.

Selection of Range 2, when possible, improves the efficiency (CoreMark<sup>®</sup> per mA) by almost 15%.

[Figure 5](#) show the Flash memory latency (number of wait states to be programmed in the Flash memory access control register), depending on regulator voltage scaling range and system clock frequency for the STM32L4 Series. For the STM32L4+ Series the corresponding data are summarized in [Table 5](#) and [Figure 5](#).

Figure 4. Flash memory latency vs. V<sub>CORE</sub> range, STM32L4 Series

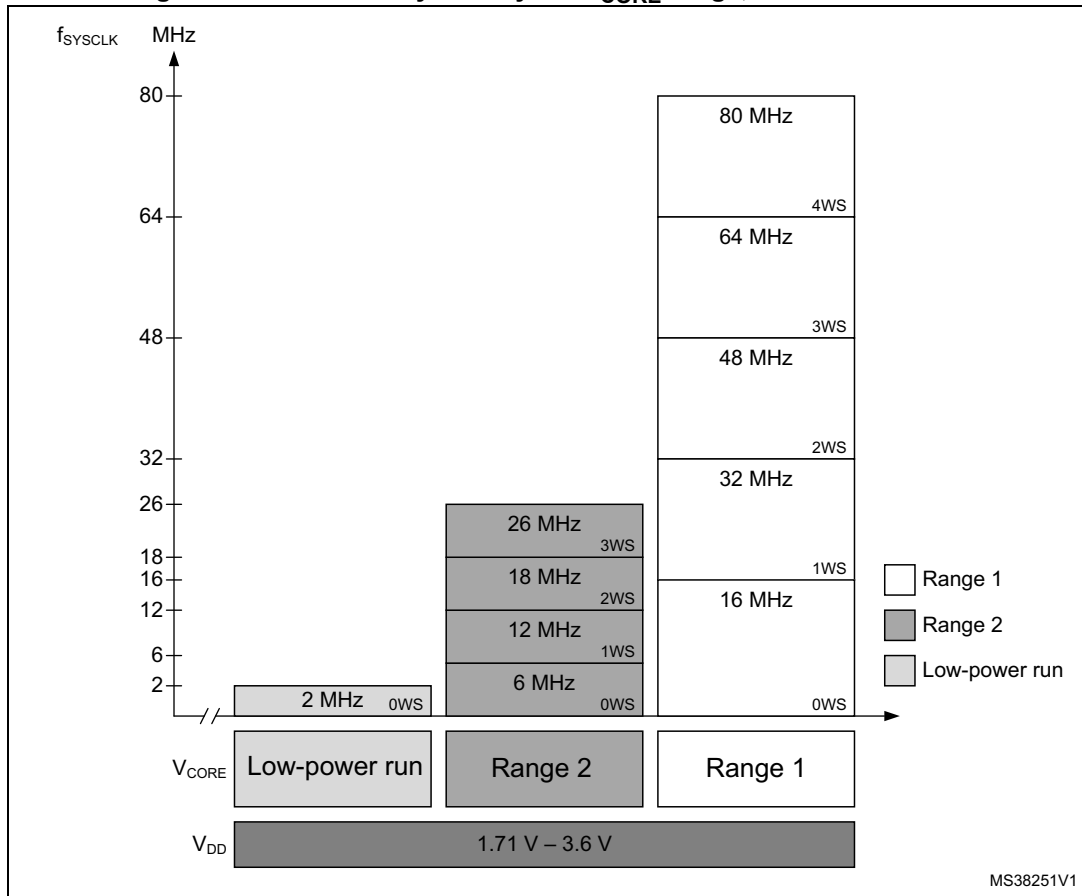

Figure 5. Flash memory latency vs. V<sub>CORE</sub> range, STM32L4+ Series

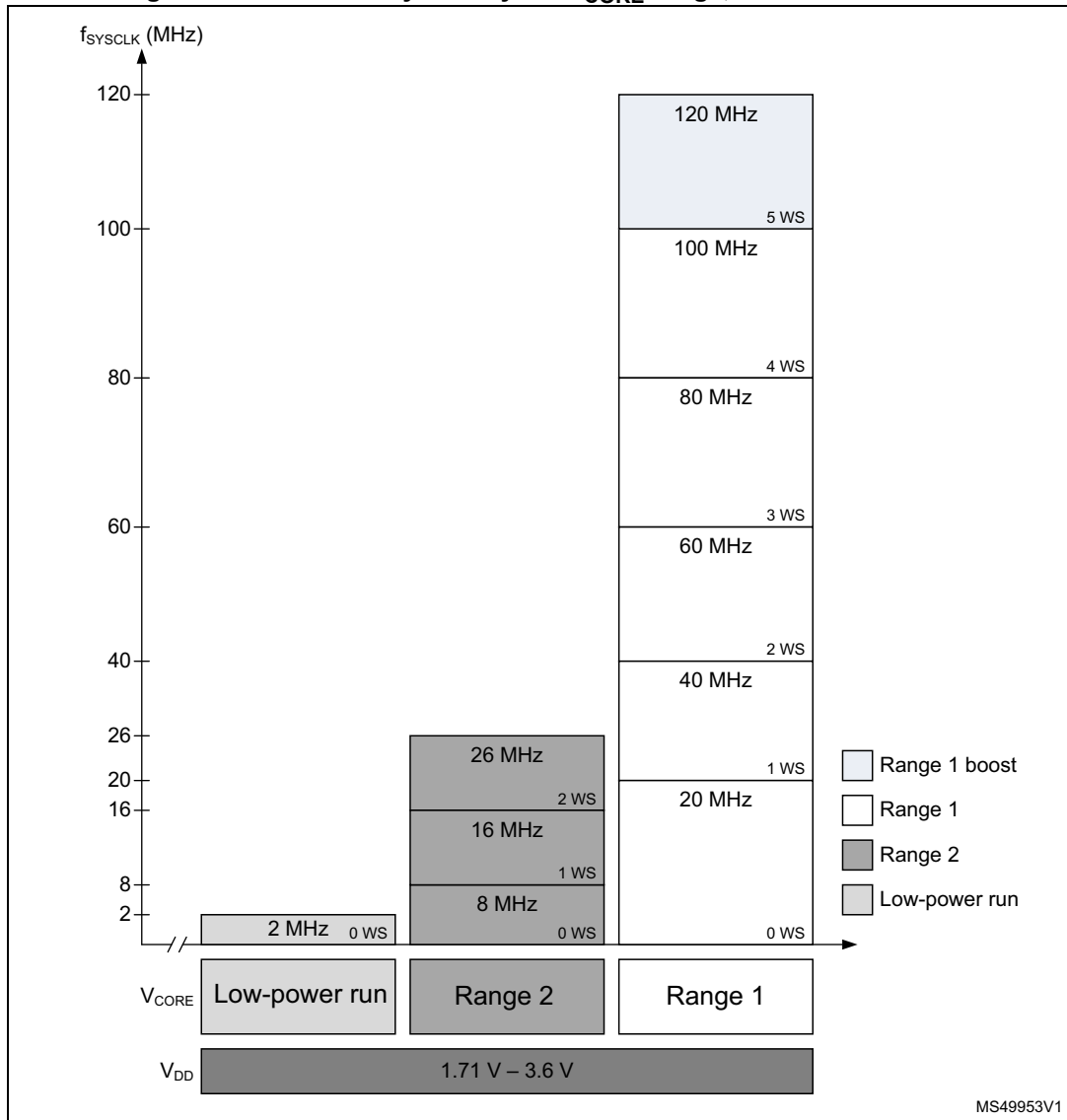

Table 5. Number of wait states vs. CPU clock (HCLK) frequency, STM32L4+ Series

Wait states (latency)	HCLK (MHz)		
	Range 1 Boost	Range 1	Range 2
0 WS (1 CPU cycles)	-	≤ 20	≤ 8
1 WS (2 CPU cycles)	-	≤ 40	≤ 16
2 WS (3 CPU cycles)	-	≤ 60	≤ 26
3 WS (4 CPU cycles)	-	≤ 80	-
4 WS (5 CPU cycles)	-	≤ 100	-
5 WS (6 CPU cycles)	≤ 120	-	-

## 2 FlexPowerControl description

FlexPowerControl reduces the application power consumption thanks to high flexibility in the power management, smart peripherals and architecture.

### 2.1 Numerous low-power modes

The microcontrollers of the STM32L4 and STM32L4+ Series implement many different power modes, seven of them are low-power.

On top of these modes, the power consumption can be modulated by selecting different clock sources and Frequencies, as well as clocking off peripherals not in use.

In all these modes, except Shutdown, the safe power monitoring Brown out reset (BOR) and the IWDG can stay active to guarantee safe execution.

[Table 6](#) summarizes the features available for each mode and provides an indication of the current consumption.

#### 2.1.1 Low-power run and Low-power sleep modes

Two low-power active modes are available on the STM32L4 Series in addition to those (Sleep, Stop and Standby) implemented on the STM32Fx Series, they are the Low-power run and Low-power sleep.

They offer Run and Sleep mode functionality for applications with extremely low current consumption where some peripherals cannot be switched off, or where the CPU is processing continuously at low speed to minimize current variations.

Several features have been put in place to reduce the current consumption:

- the core logic is supplied by the low-power voltage regulator to reduce the quiescent current;
- the Flash memory can be switched off (power-down mode and clock gating) in Low-power sleep mode. It can also be switched off in Low-power run when the processor is executing from SRAM1 or SRAM2;
- the system clock is limited to 2 MHz maximum. The MSI internal RC oscillator can be selected as it supports several frequency ranges, with a small MCU total consumption down to 18  $\mu$ A in Low-power sleep Flash memory off at 100 kHz.

#### Batch acquisition sub-mode (BAM)

The STM32L4 microcontrollers support the power efficient batch acquisition sub-mode (BAM), in which data are transferred with communication peripherals, while the rest of the device is in low-power mode.

This is achieved by entering Sleep or Low-power sleep mode with this configuration:

- only the DMA, the communication peripheral(s) and the SRAM1 or SRAM2 clocks are enabled in Sleep (or Low-power sleep) mode;
- the Flash memory is off in Sleep (or Low-power sleep) mode: the Flash memory is in power-down and the Flash memory clock is gated off;
- if the system clock can be limited to 2 MHz, the main regulator is switched off (to enter Low-power sleep).

In Low-power sleep mode, the I2C and USART/LPUART peripherals can still be clocked with HSI at 16 MHz. This allows supporting BAM with I2C or USART at up to 1 Mbps speed.

### 2.1.2 Stop mode

The STM32L4 Series implements three Stop modes with full SRAM and Peripheral retention capability and capacity to wakeup in 1  $\mu$ s thanks to the use of the MSI up to 48 MHz.

In these Stop modes all the high speed oscillators (HSE, MSI, HSI) are stopped, while the low speed ones (LSE, LSI) can be kept active. The peripherals can be set active, using the HSI clock when needed, to be able to wakeup the device on some specific events (such as UART character reception or I2C address recognition).

Stop2 mode implements a dedicated mechanism to keep the retention current as low as possible while allowing a very fast wakeup of 5  $\mu$ s from SRAM or 8  $\mu$ s from Flash memory.

### 2.1.3 Standby mode

In Standby mode the BOR is always enabled, ensuring that the device is under reset when the supply voltage is below the selected functional threshold.

By default the SRAMs content is lost in Standby mode. However, it is possible to preserve the content of the SRAM2 (with an additional current consumption). On some devices, a retention switch allows different amounts of memory to be retained.

Pull-up and pull-down can individually be applied on each I/O during the Standby mode, allowing external devices configuration to be kept.

Wakeup from this mode is done thanks to one of the five wakeup pins, the reset pin or the independent watchdog. The RTC clocked by the low-speed oscillators (LSE or LSI) is also functional in this mode, with wakeup capability.

### 2.1.4 Shutdown mode

A new Shutdown mode is implemented in the STM32L4xx devices in order to lengthen even more the battery life of battery-powered applications.

This mode allows the lowest consumption, by switching off the internal voltage regulators, and by disabling the voltage power monitoring. Wakeup from this mode is done thanks to one of the five wakeup pins or to the reset pin. The RTC clocked by the low-speed external oscillator (LSE) is also functional in this mode, with wakeup capability.



Table 6. STM32L4 modes overview

Mode	Regulator <sup>(1)</sup>	CPU	Flash	SRAM	Clocks	DMA and Peripherals <sup>(2)</sup>	Wakeup source	Consumption <sup>(3)</sup>	Wakeup time <sup>(4)</sup>
Run	Range 1	Yes	ON <sup>(5)</sup>	ON	Any	All	N/A	107 µA/MHz	N/A
	Range 2					All except USB, RNG		92 µA/MHz	
LPRun	LPR	Yes	ON <sup>(5)</sup>	ON	Any except PLL	All except USB, RNG	N/A	102 µA/MHz	To Range 1: 4 µs To Range 2: 64 µs
Sleep	Range 1	No	ON <sup>(5)</sup>	ON <sup>(6)</sup>	Any	All	Any interrupt or event	28 µA/MHz	6 cycles
	Range 2					All except USB, RNG		26 µA/MHz	6 cycles
LPSleep	LPR	No	ON <sup>(5)</sup>	ON <sup>(6)</sup>	Any except PLL	All except USB, RNG	Any interrupt or event	36 µA/MHz	6 cycles
Stop0	MR	No	Off	ON	LSE LSI	BOR, PVD, PVM, RTC, LCD, IWDG COMPx (x=1, 2), DACx (x=1, 2) OPAMPx (x=1, 2) USARTx (x=1...5) <sup>(7)</sup> LPUART1 <sup>(7)</sup> I2Cx (x=1...4) <sup>(8)</sup> LPTIMx (x=1, 2) All other peripherals are frozen.	Reset pin, all I/Os BOR, PVD, PVM RTC, LCD, IWDG COMPx (x=1, 2) USARTx (x=1...5) <sup>(7)</sup> LPUART1 <sup>(7)</sup> I2Cx (x=1...4) <sup>(8)</sup> LPTIMx (x=1, 2) USB <sup>(9)</sup> SWPMI <sup>(10)</sup>	100 µA	0.7 µs in SRAM 4.5 µs in Flash
Stop1	LPR	No	Off	ON	LSE LSI	BOR, PVD, PVM, RTC, LCD, IWDG COMPx (x=1, 2), DACx (x=1, 2) OPAMPx (x=1, 2) USARTx (x=1...5) <sup>(7)</sup> LPUART1 <sup>(7)</sup> I2Cx (x=1...4) <sup>(8)</sup> LPTIMx (x=1, 2) All other peripherals are frozen.	Reset pin, all I/Os BOR, PVD, PVM RTC, LCD, IWDG COMPx (x=1, 2) USARTx (x=1...5) <sup>(7)</sup> LPUART1 <sup>(7)</sup> I2Cx (x=1...4) <sup>(8)</sup> LPTIMx (x=1, 2) USB <sup>(9)</sup> SWPMI <sup>(10)</sup>	4.3 µA w/o RTC 4.6 µA w RTC	4 µs in SRAM 6 µs in Flash

**Table 6. STM32L4 modes overview (continued)**

Mode	Regulator <sup>(1)</sup>	CPU	Flash	SRAM	Clocks	DMA and Peripherals <sup>(2)</sup>	Wakeup source	Consumption <sup>(3)</sup>	Wakeup time <sup>(4)</sup>
Stop2	LPR	No	Off	ON	LSE LSI	BOR, PVD, PVM RTC, LCD, IWDG COMPx (x=1, 2), I2C3 <sup>(8)</sup> LPUART1 <sup>(7)</sup> , LPTIM1, LPTIM2 <sup>(11)</sup> All other peripherals are frozen.	Reset pin, all I/Os BOR, PVD, PVM RTC, LCD, IWDG COMPx (x=1, 2) I2C3 <sup>(8)</sup> LPUART1 <sup>(7)</sup> LPTIM1, LPTIM2 <sup>(11)</sup>	1.0 $\mu$ A w/o RTC 1.3 $\mu$ A w/RTC	5 $\mu$ s in SRAM 7 $\mu$ s in Flash
Standby	LPR	Powered Off	Off	SRAM2 ON	LSE LSI	BOR, RTC, IWDG All other peripherals are powered off. I/O configuration can be floating, pull-up or pull-down	Reset pin 5 I/Os (WKUPx) <sup>(12)</sup> BOR, RTC, IWDG	0.20 $\mu$ A w/o RTC 0.45 $\mu$ A w/ RTC	14 $\mu$ s
	OFF			Powered dOff				0.03 $\mu$ A w/o RTC 0.28 $\mu$ A w/ RTC	
Shutdown	OFF	Powered Off	Off	Powered dOff	LSE	RTC All other peripherals are powered off. I/O configuration can be floating, pull-up or pull-down <sup>(13)</sup>	Reset pin 5 I/Os (WKUPx) <sup>(12)</sup> RTC	8 nA w/o RTC 260 nA w/ RTC	256 $\mu$ s

- LPR means Main regulator is OFF and Low-power regulator is ON.
- All peripherals can be active or clock gated to save power consumption.
- Typical current consumption for STM32L433 device at  $V_{DD} = 1.8$  V, 25°C. Consumptions values provided running from SRAM, Flash memory Off, 80 MHz in Range 1, 26 MHz in Range 2, 2 MHz in LPRun/LPSleep.
- Typical wakeup values for STM32L476.
- The Flash memory can be put in power-down and its clock can be gated off when executing from SRAM.
- The SRAM1 and SRAM2 clocks can be gated on or off independently.
- U(S)ART and LPUART reception is functional in Stop mode, and generates a wakeup interrupt on Start, address match or received frame event.
- I2C address detection is functional in Stop mode, and generates a wakeup interrupt in case of address match.
- USB wakeup by resume from suspend and attach detection protocol event.
- SWPMI wakeup by resume from suspend.
- On L4P5/If supported by device.
- The I/Os with wakeup from Standby/Shutdown capability are: PA0, PC13, PE6, PA2, PC5.
- I/Os can be configured with internal pull-up, pull-down or floating in Shutdown mode but the configuration is lost when exiting the Shutdown mode.

Figure 6 shows the possible mode transitions in the application:

Figure 6. Low-power modes possible transitions

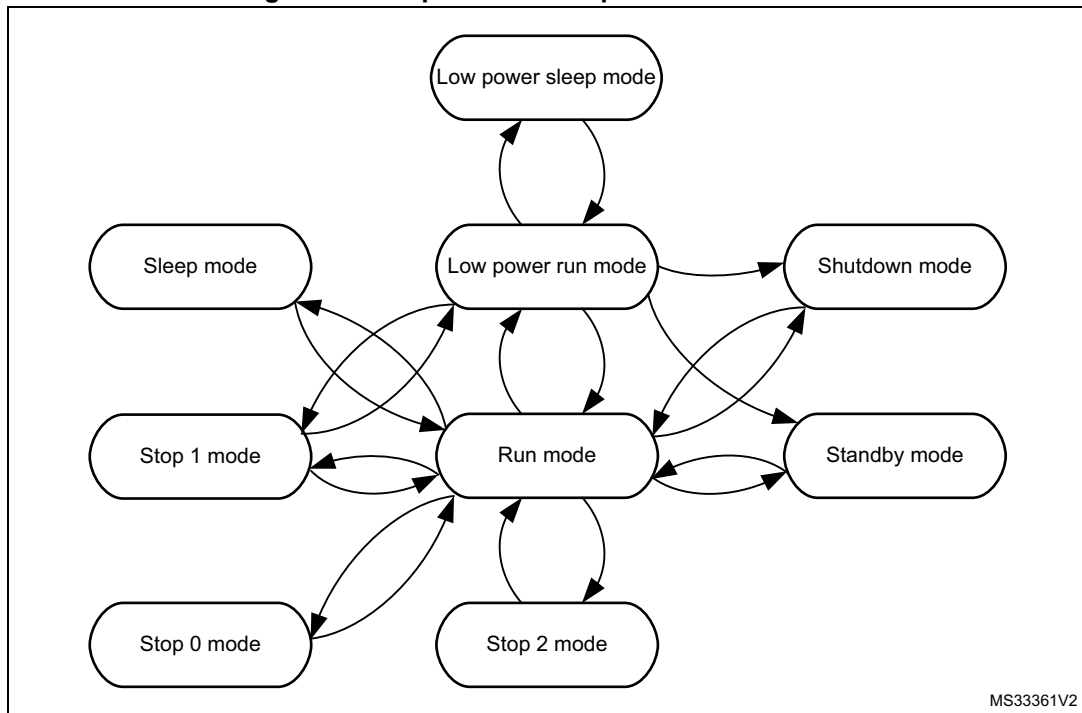

## 2.2 Multi-supply and battery backup domain

The STM32L4xx devices require a 1.71 to 3.6 V  $V_{DD}$  operating voltage supply.

Several independent supplies ( $V_{DDA}$ ,  $V_{DDIO2}$ ,  $V_{DDUSB}$ ), can be provided for specific peripherals, thus removing the constraint to supply all product at high voltage when analog or USB functions are used. Supplying the MCU with low  $V_{DD}$  voltage allows to reduce the consumption in the low power modes. When the peripherals supplied by the independent power supplies are not used in the application, those supplies should be connected to  $V_{DD}$ .

- $V_{DD} = 1.71$  to 3.6 V  
 $V_{DD}$  is the external power supply for the I/Os, the internal regulator and the system analog such as reset, power management and internal clocks. It is provided externally through VDD pins.
- $V_{DD12} = 1.05$  to 1.32 V  
 External power supply, connected to  $V_{CORE}$ , bypassing the internal regulator when connected to an external SMPS. It is provided externally through VDD12 pins, and is only available on packages with the external SMPS supply option.
- $V_{DDA}$  minimum voltage:
  - 1.62 V if ADC or COMPs are used;
  - 1.8 V if DAC or OPAMPS are used;
  - 2.4 V if the built-in Reference source need to be used for  $V_{REF}$ .

$V_{DDA}$  is the external analog power supply for A/D converters, D/A converters, voltage reference buffer, operational amplifiers and comparators.



- $V_{DDUSB} = 3.0$  to  $3.6$  V (USB used)  
 $V_{DDUSB}$  is the external independent power supply for USB transceivers.
- $V_{DDIO2} = 1.08$  to  $3.6$  V  
 $V_{DDIO2}$  is the external power supply for 14 I/Os (Port G[15:2]).
- $V_{DDDSI}$  (if available on the device) is used to supply the DSI regulator and MIPI D-PHY. It must be connected to  $V_{DD}$ :
- $V_{CAPDSI}$  (if available on the device) is the output of DSI regulator. It must be connected to  $V_{DD12DSI}$ :

In addition, the STM32L4xx devices support two voltage reference supplies:

- $V_{LCD} = 2.5$  to  $3.6$  V (if available on the device)  
The voltage reference for the LCD ( $V_{LCD}$ ) is used to control the contrast of the glass LCD. It can be provided either from external supply voltage or by embedded voltage step-up converter, independently of  $V_{DD}$  voltage.  $V_{LCD}$  is multiplexed with PC3 which can be used as GPIO when the LCD is not used.
- $V_{REF+}$   
 $V_{REF+}$  is the input reference voltage for ADCs and DACs. It is also the output of the internal voltage reference buffer when enabled.  $V_{REF+}$  pin, and thus internal voltage reference, is not available on all packages. When the  $V_{REF+}$  is double-bonded with  $V_{DDA}$  in a package, the internal voltage reference buffer is not available and must be kept disable (refer to datasheet for packages pinout description).

To retain the content of the Backup registers and supply the RTC function when  $V_{DD}$  is turned off, the  $V_{BAT}$  pin can be connected to an optional backup voltage supplied by a battery or by another source:

- $V_{BAT} = 1.55$  to  $3.6$  V  
 $V_{BAT}$  is the power supply for RTC, external clock 32 kHz LSE oscillator and backup registers (through power switch) when  $V_{DD}$  is not present. When  $V_{DD}$  is present these peripherals (RTC, LSE..) are automatically supplied by  $V_{DD}$ , and it's possible to charge the external battery on  $V_{BAT}$  through an internal resistance.

An embedded linear voltage regulator is used to supply the internal digital power  $V_{CORE}$ , the power supply for digital peripherals and memories. Thanks to the internal voltage regulator and voltage scaling, the STM32L4xx devices consumption in active modes is kept at a minimum, whatever the supply voltage.

The STM32L4 devices with a P suffix allow the designer to use an external SMPS to force an external  $V_{DD12}$  supply on the digital logic (refer to AN4978, available on [www.st.com](http://www.st.com), for detailed schematic and operation). When  $V_{DD12}$  is forced by an external source and is higher than the output of the internal LDO, the current is taken from this external supply, and the overall power efficiency is significantly improved when using an external step down DC/DC converter.

*Note:* *Not all supply pins are present on all packages.*

Figure 7. Power supply overview

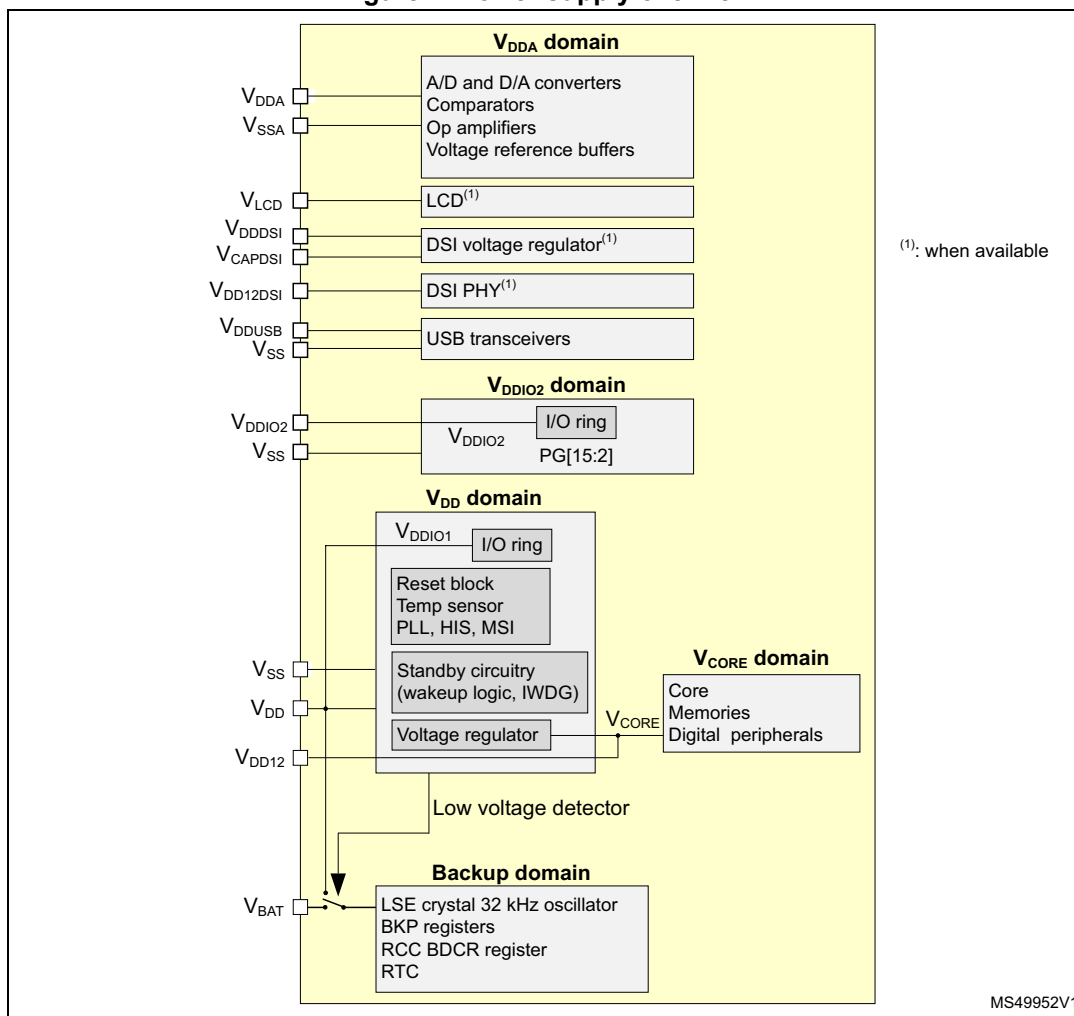

### 2.3 Ultra-safe supply monitoring

The STM32L4xx microcontrollers include a sophisticated supply supervisor module with several programmable options. This module is active during both power-on/down and run-time phases.

The power-up is a critical phase where the various parts of the internal circuitry must be sequentially started and critical parameters (such as factory trimming values or options) retrieved from the non-volatile memory to perform MCU initialization, even before the user reset phase. It is also during this period that V<sub>DD</sub> can be altered with glitches coming from the battery insertion or because of a weak power source.

The ultra-safe BOR circuitry guarantees that the reset is released only if the V<sub>DD</sub> is above the selected threshold, whatever the slope of the V<sub>DD</sub> ramp-up phase, so that the circuit is within its guaranteed operating conditions when the program execution starts. A reset is generated when V<sub>DD</sub> falls down below the selected threshold. Five thresholds can be selected depending on the value stored in Flash memory option byte. The BOR minimum threshold is 1.71 V, guaranteeing that the MCU exits reset above 1.71 V enabling to supply the MCU with voltage reference of 1.8 V ± 5%.



The BOR is enabled in all modes except Shutdown mode. In Shutdown mode the power monitoring is disabled, as a consequence the switch to  $V_{BAT}$  domain when  $V_{DD}$  is not present (and vice-versa) is not supported in Shutdown mode.

In addition, a 7-level programmable voltage detector (PVD) is available to generate an early interrupt in case of a voltage drop.

Finally, the independent power supplies ( $V_{DDA}$ ,  $V_{DDUSB}$  and  $V_{DDIO2}$ ) can be monitored by comparison with a fixed voltage threshold, and generate an interrupt in case power is below the threshold.

The PVD and PVM can wakeup from Stop modes.

## 2.4 A set of peripherals tailored for low power

Some peripherals require special attention, either because of their intrinsic high consumption, or because they are always powered up.

- The STM32L4xx MCUs embed multiple 12-bit / 5 Msps ADCs. Each of these very fast and accurate converters can jeopardize the battery lifetime if left powered-up continuously, with a 1 mA typical consumption at 5 Msps. As the ADC consumption is roughly proportional to the acquisition frequency (around 200  $\mu$ A / Msps), from consumption standpoint the application can choose between two solutions, i.e. either performing the acquisition at low speed to limit maximum current, or doing it at maximum speed to switch in ultra-low power mode quickly.

When the acquisition is performed slowly, the ADC consumption itself can go down to few tens of  $\mu$ A drastically limiting the maximum current. This can be mandatory when the power source provides a limited current. The drawback, if the CPU has no other task to perform during that time, can be the increased time spent in run or sleep mode (or Low Power run or Low power sleep modes) versus the time spent in ultra-low power mode (Stop or Standby).

Several peripherals have been developed to operate even in Stop mode, when the system clock is stopped, with the main oscillator and memory powered down.

- A pair of ultra-low power comparators is available to monitor analog voltages with a current down to 350 nA. These comparators can wake up the MCU as soon as the external voltage reaches the selected threshold and they can be combined together to provide a window comparator. One of these comparators has a rail-to-rail input capability and its output can be redirected to a timer for a general purpose use.
- The devices embed multiple DACs, with sample and hold capability supported in Stop1 mode. In sample and hold mode, the DAC core converts data on a triggered conversion, then holds the converted voltage on a capacitor. When not converting, the DAC cores and buffer are completely turned off between samples and the DAC output is tri-stated, therefore reducing the overall power consumption.
- An RTC peripheral provides a clock/calendar with two alarms, includes a periodic wake-up unit and several application specific functions (such as timestamp, tamper detection). It can remain enabled in the lowest power mode (shutdown), when most of the chip is powered down, and wake up the full MCU circuitry in case of an alarm or tamper detection, for instance. It also contains up to 128 bytes of backup registers to store contextual information when exiting from standby mode, or to store sensitive information as they are protected by tamper detection, and readout memory

protection. This peripheral has been designed using asynchronous design techniques to minimize its consumption.

The RTC can be clocked by two low-power low-speed clocks:

- LSE: the external 32.768 kHz quartz oscillator supports four power consumption modes, combined with drive capability;
  - LSI: when deep accuracy is not required, the RTC can be clocked by an internal 32 kHz oscillator, with extremely low consumption.
- The glass LCD is one of the most common displays in low power applications, because of its inherently low current consumption, low price and customizing easiness. The STM32L4 Series includes a versatile LCD controller, which can drive displays with up to 8 common lines and 32 segments, with the capability of selecting individually the I/O ports assigned to the LCD for an optimal use of the chip alternate functions. It also controls an optional internal step-up converter to maintain the LCD contrast on a wide range of  $V_{DD}$  values with consumptions as low as 5  $\mu$ A (LCD consumption not included).
  - The Low power timer (LPTIM) is a 16-bit timer that benefits from the ultimate developments in power consumption reduction. Thanks to its diversity of clock sources, the LPTIM is able to keep running whatever the selected power mode. Given its capability to run even with no internal clock source, the LPTIM can be used as “Pulse Counter” which can be useful in some applications. Also, the LPTIM capability to wake up the system from low power modes, makes it suitable to make “Time-out functions” with extremely low power consumption. The LPTIM introduces a flexible clock scheme that provides the needed functionality and performance, while minimizing the power consumption.
  - The low power universal asynchronous receiver transmitter (LPUART) is an UART which allows bidirectional UART communications with a limited power consumption. Only 32.768 kHz LSE clock is required to allow UART communications up to 9600 bauds. Higher baud rates can be reached when the LPUART is clocked by clock sources different from the LSE clock. Even when the MCU is in Stop modes, the LPUART can wait for an incoming UART frame while having an extremely low energy consumption.  
Several sources of wakeup from Stop mode can be selected:
    - wakeup on address match
    - wakeup on Start bit detection
    - wakeup on received byte.
  - The I2C is able to wakeup the MCU from Stop modes (APB clock is off), when it is addressed. All addressing modes are supported. The HSI oscillator must be selected as the clock source for I2CCLK in order to allow wakeup from Stop. During Stop mode, the HSI is switched off. When a START is detected, the I2C interface switches the HSI on, and stretches SCL low until HSI is woken up. HSI is then used for the address reception. In case of an address match, the I2C stretches SCL low during MCU wakeup time. The stretch is released when ADDR flag is cleared by software, and the transfer goes on normally. If the address does not match, the HSI is switched off again and the MCU is not woken up.
  - The USART is able to wakeup the MCU from Stop0/1 mode when USART clock is HSI or LSE. Several sources of wakeup from Stop0/1 mode can be selected:
    - wakeup on address match
    - wakeup on Start bit detection
    - wakeup on received byte.

- The USB can wakeup from Stop0/1 mode with these events:
  - Resume from Suspend
  - Attach detection protocol event
- The SWPMI can wakeup from Stop0/1 mode with this event:
  - Resume from Suspend

**Table 7** summarizes the peripheral features over all available modes. Wakeup capability is detailed in gray cells.

**Table 7. Features over all modes<sup>(1)</sup>**

Peripheral	Run Range 1 boost	Run Range 1	Run Range 2	Sleep	Low-power run	Low-power sleep	Stop0/1		Stop2		Standby		Shutdown		VBAT
							-	Wakeup capability	-	Wakeup capability	-	Wakeup capability	-	Wakeup capability	
CPU		Y		-	Y	-	-	-	-	-	-	-	-	-	-
Flash access (up to 2 MB)		O <sup>(2)</sup>		O <sup>(2)</sup>	O <sup>(2)</sup>	O <sup>(2)</sup>	-	-	-	-	-	-	-	-	-
SRAM1 (up to 256 KB)		Y		Y <sup>(3)</sup>	Y	Y <sup>(3)</sup>	Y	-	Y	-	-	-	-	-	-
SRAM2 (up to 64 KB)		Y		Y <sup>(3)</sup>	Y	Y <sup>(3)</sup>	Y	-	Y	-	O <sup>(4)</sup>	-	-	-	-
SRAM3 <sup>(5)</sup> (up to 384 KB)		Y <sup>(3)</sup>		Y <sup>(3)</sup>	Y	Y <sup>(3)</sup>	Y	-	Y						
FMC or FSMC		O		O	O	O	-	-	-	-	-	-	-	-	-
Quad-SPI or OctoSPI		O		O	O	O	-	-	-	-	-	-	-	-	-
Backup Registers		Y		Y	Y	Y	Y	-	Y	-	Y	-	Y	-	Y
Brown-out reset (BOR)		Y		Y	Y	Y	Y	Y	Y	Y	Y	Y	-	-	-
Programmable Voltage Detector (PVD)		O		O	O	O	O	O	O	O	-	-	-	-	-
Peripheral Voltage Monitor (PVMx; x=1, 2, 3, 4)		O		O	O	O	O	O	O	O	-	-	-	-	-
DMA		O		O	O	O	-	-	-	-	-	-	-	-	-
DMA2D <sup>(5)</sup>		O		O	O	O	-	-	-	-	-	-	-	-	-
High Speed Internal (HSI16)		O		O	O	O	(6)	-	(6)	-	-	-	-	-	-
High Speed External (HSE)		48 <sup>(7)</sup>		26 <sup>(7)</sup>	O <sup>(8)</sup>	O	O	-	-	-	-	-	-	-	-
Oscillator HSI48 <sup>(5)</sup>		O		O	-	-	-	-	-	-	-	-	-	-	-

Table 7. Features over all modes<sup>(1)</sup> (continued)

Peripheral	Run Range 1 boost	Run Range 1	Run Range 2	Sleep	Low-power run	Low-power sleep	Stop0/1		Stop2		Standby		Shutdown		VBAT
							-	Wakeup capability	-	Wakeup capability	-	Wakeup capability	-	Wakeup capability	
Low Speed Internal (LSI)	0			0	0	0	0	-	0	-	0	-	-	-	-
Low Speed External (LSE)	0			0	0	0	0	-	0	-	0	-	0	-	0
Multi-Speed Internal (MSI)	48 <sup>(9)</sup>		24 <sup>(9)</sup>	0	0	0	-	-	-	-	-	-	-	-	-
PLLx VCO maximum frequency	344		128	0 <sup>(8)</sup>	-	-	-	-	-	-	-	-	-	-	-
Clock Security System (CSS)	0			0	0	0	-	-	-	-	-	-	-	-	-
Clock Security System on LSE	0			0	0	0	0	0	0	0	0	0	-	-	-
RTC / Auto wakeup	0			0	0	0	0	0	0	0	0	0	0	0	0
Camera interface <sup>(5)</sup>	0			0	0	0	-	-	-	-	-	-	-	-	-
Number of RTC Tamper pins	3			3	3	3	3	0	3	0	3	0	3	0	3
LCD	0			0	0	0	0	0	0	0	-	-	-	-	-
LCD-TFT <sup>(5)</sup>	0		-	0	-	-	-	-	-	-	-	-	-	-	-
GFXMMU <sup>(5)</sup>	0			0	0	0	-	-	-	-	-	-	-	-	-
DSIHOST <sup>(5)</sup>	0			-	-	-	-	-	-	-	-	-	-	-	-
Camera interface	0			0	0	0	-	-	-	-	-	-	-	-	-
USB OTG FS	0		-	0	-	-	-	0	-	-	-	-	-	-	-
USB FS	0		-	0	-	-	-	0	-	-	-	-	-	-	-
USARTx (x=1, 2, 3, 4, 5)	0			0	0	0	0 <sup>(10)</sup>	0 <sup>(10)</sup>	-	-	-	-	-	-	-
Low-power UART (LPUART)	0			0	0	0	0 <sup>(10)</sup>	0 <sup>(10)</sup>	0 <sup>(10)</sup>	0 <sup>(10)</sup>	-	-	-	-	-
I2Cx (x=1, 2, 4)	0			0	0	0	0 <sup>(11)</sup>	0 <sup>(11)</sup>	-	-	-	-	-	-	-
I2C3	0			0	0	0	0 <sup>(11)</sup>	0 <sup>(11)</sup>	0 <sup>(11)</sup>	0 <sup>(11)</sup>	-	-	-	-	-
SPIx (x=1, 2, 3)	0			0	0	0	-	-	-	-	-	-	-	-	-
CAN (x=1, 2)	0			0	0	0	-	-	-	-	-	-	-	-	-
SDMMC (x=1, 2)	0			0	0 <sup>(5)</sup>	0 <sup>(5)</sup>	-	-	-	-	-	-	-	-	-
SWPMI <sup>(5)</sup>	0			0	0	0	-	0	-	-	-	-	-	-	-

Table 7. Features over all modes<sup>(1)</sup> (continued)

Peripheral	Run Range 1 boost	Run Range 1	Run Range 2	Sleep	Low-power run	Low-power sleep	Stop0/1		Stop2		Standby		Shutdown		VBAT
							-	Wakeup capability	-	Wakeup capability	-	Wakeup capability	-	Wakeup capability	
PSSI		O		O	O	O	-	-	-	-	-	-	-	-	-
PKA		O		O	O	O	-	-	-	-	-	-	-	-	-
SAIx (x=1, 2)		O		O	O	O	-	-	-	-	-	-	-	-	-
DFSDM		O		O	O	O	-	-	-	-	-	-	-	-	-
ADCx (x=1, 2, 3)		O		O	O	O	-	-	-	-	-	-	-	-	-
DACx (x=1, 2)		O		O	O	O	O	-	-	-	-	-	-	-	-
VREFDBUF		O		O	O	O	-	-	-	-	-	-	-	-	-
OPAMPx (x=1, 2)		O		O	O	O	O	-	-	-	-	-	-	-	-
COMPx (x=1, 2)		O		O	O	O	O	O	O	O	O	-	-	-	-
Temperature sensor		O		O	O	O	-	-	-	-	-	-	-	-	-
Timers (TIMx)		O		O	O	O	-	-	-	-	-	-	-	-	-
Low-power Timer 1 (LPTIM1)		O		O	O	O	O	O	O	O	O	-	-	-	-
Low-power Timer 2 (LPTIM2)		O		O	O	O	O	O	O <sup>(5)</sup>	-	-	-	-	-	-
Independent watchdog (IWDG)		O		O	O	O	O	O	O	O	O	O	O	-	-
Window watchdog (WWDG)		O		O	O	O	-	-	-	-	-	-	-	-	-
SysTick timer		O		O	O	O	-	-	-	-	-	-	-	-	-
Touch sensing controller (TSC)		O		O	O	O	-	-	-	-	-	-	-	-	-
Random number generator (RNG)		O	-	O	-	-	-	-	-	-	-	-	-	-	-
AES hardware accelerator		O		O	O	O	-	-	-	-	-	-	-	-	-
HASH hardware acceleration		O		O	O	O	-	-	-	-	-	-	-	-	-
CRC calculation unit		O		O	O	O	-	-	-	-	-	-	-	-	-
GPIOs		O		O	O	O	O	O	O	O	O	(12) 5 pins	(13) 5 pins	-	-

1. Legend: Y = Yes (Enabled). O = Optional (Disabled by default, can be enabled by software). - = Not available.

2. The Flash memory can be configured in power-down mode. By default, it is not in power-down mode.

3. The SRAM clock can be gated on or off.
4. SRAM2 content is preserved when the bit RRS is set in PWR\_CR3 register.
5. If supported by device.
6. Some peripherals with wakeup from Stop capability can request HSI to be enabled. In this case, HSI is woken up by the peripheral, and only feeds the peripheral which requested it. HSI is automatically put off when the peripheral does not need it anymore.
7. HSE maximum frequency.
8. The HSE and PLL have the same maximum frequency as the associated Run mode.
9. MSI maximum frequency..
10. UART and LPUART reception is functional in Stop mode, and generates a wakeup interrupt on Start, address match or received frame event.
11. I2C address detection is functional in Stop mode, and generates a wakeup interrupt in case of address match.
12. I/Os can be configured with internal pull-up, pull-down or floating in Standby mode.
13. I/Os can be configured with internal pull-up, pull-down or floating in Shutdown mode but the configuration is lost when exiting the Shutdown mode.



## 2.5 A versatile clock management

A reset and clock controller (RCC) peripheral manages the five possible clock sources of the STM32L4 microcontrollers.

Two external oscillators can be used for applications requiring high precision:

- The HSE clock (4 to 48 MHz high speed external clock), typically used to feed the PLL and to generate a CPU clock frequency of up to 80/120 MHz, respectively, on the STM32L4/STM32L4+ Series and independent required frequencies for the USB controller and the audio clocks.
- The LSE (typically 32.768 kHz low speed external clock) normally used to provide a low power clock source to the real time clock but which can also be used as LCD clock.

Three internal oscillators can be selected for various tasks:

- The LSI clock (32 kHz low speed internal clock) is a ultra-low power source that can feed the real time clock (with a limited accuracy), the LCD controller and the independent watchdog
- The HSI clock (16 MHz high speed internal clock) is a high speed voltage-compensated oscillator.
- The MSI clock (100 kHz to 48 MHz multi speed internal clock) is an oscillator with adjustable frequency and low current consumption. It is designed to operate with a current proportional to the frequency, so as to minimize the internal oscillator consumption overhead for the low CPU frequencies. This oscillator can provide high-accuracy when configured in PLL-mode, where it is auto-calibrated using the LSE.
- The RC48, when available, with clock recovery system (HSI48): the internal 48 MHz clock source (HSI48) can be used to drive the USB, the SDMMC or the RNG peripherals. This clock can be output on the MCO.

[Table 8](#) summarizes the characteristics and uses of the various oscillators.

**Table 8. STM32L4xx clock source characteristics<sup>(1)</sup>**

Clock source	Use	Frequency	Consumption (typical)	Accuracy	Trimming	
					Factory	User
HSE	Master clock (+ RTC & LCD)	4-48 MHz	-	Crystal dependent, down to tens of ppm	Not applicable	
LSE	RTC and LCD USART, LPUART, LPTIM independent clock	32.768 kHz (typical)	250 nA	Crystal dependent, down to a few ppm		
HSI	Master clock Peripheral independent clock	16 MHz	150 $\mu$ A	$\pm 0.8$ % typical over -10 to +85 °C  +0.1/-0.2 % typical over 1.62 to 3.6 V	Yes	Yes

Table 8. STM32L4xx clock source characteristics<sup>(1)</sup> (continued)

Clock source	Use	Frequency	Consumption (typical)	Accuracy	Trimming	
					Factory	User
MSI	Master clock	100 kHz 200 kHz 400 kHz 800 kHz 1 MHz 2 MHz 4 MHz 8 MHz 16 MHz 24 MHz 32 MHz <sup>(2)</sup> 48 MHz <sup>(2)</sup>	0.6 $\mu$ A 0.8 $\mu$ A 1.2 $\mu$ A 1.9 $\mu$ A 4.7 $\mu$ A 6.5 $\mu$ A 11 $\mu$ A 18.5 $\mu$ A 62 $\mu$ A 85 $\mu$ A 110 $\mu$ A 155 $\mu$ A	Default mode: +1.5/-1 % typical over -10 to +85 °C  +1.5/-5.5 % typical for 16 to 48 MHz over 1.62 to 3.6 V  PLL-mode: better than 0.25 %	Yes	Yes
LSI	RTC, LCD and IWDG	32 kHz	110 nA	$\pm$ 1.5 % typical over -40 to +125 °C  +0.5/-1.5 % typical over 1.62 to 3.6 V	Yes	No
HSI48	USB, RNG	48 MHz	340 nA	$\pm$ 3 % max over 15 to 85 °C $V_{dd} = 3.0$ to 3.6 V  $\pm$ 4.5 % max over -40 to +125 °C $V_{dd} = 1.65$ to 3.6 V	Yes	USB PLL

1. Preliminary characteristics, for information only. See product datasheet for detailed electrical characteristics.

2. Only possible in Range 1, due to Flash memory latency constraints.

In addition, the STM32L4xx microcontrollers embed three PLLs, each of them provides up to three independent outputs and can be fed by the HSI, the HSE or the MSI. The nine outputs can be configured independently for:

- the system clock
- the ADC interface clock
- the USB clock
- the Serial Audio Interface SAI1 clock
- the Serial Audio Interface SAI2 clock

This removes the peripheral constraints on the system clock. Many other peripherals, when available, can be clocked independently from the system clock: USARTx (x= 1, 2, 3, 4, 5), LPUART, SWPMI and I2Cx (x=1, 2, 4) receive an independent clock. This makes it possible, as an example, to reduce the system and APB bus frequencies and keep the communication peripheral baud rate constant, independent from the system clock frequency.

All peripherals clock can be individually enabled or disabled in Run and Low-power run modes.

The peripheral clocks can also be individually enabled or disabled in Sleep and Low-power sleep modes.

The price of a crystal oscillator may not be neglected in cost sensitive applications. For this reason, the STM32L4xx microcontrollers offer several options to measure the internal oscillators.

Although HSI and MSI are factory trimmed, they can be further trimmed by 0.5% steps during run time to compensate for frequency deviations due to temperature and voltage changes.

When LSE is present in the application, the MSI can be automatically calibrated using the LSE (PLL-mode configuration), making it possible to reach long-term LSE accuracy. This mode can provide the USB clock, with the accuracy required to operate in device mode, saving the cost of a high-speed crystal oscillator.

Moreover the system clock when the MCU exits from Stop modes can be configured to be either HSI or MSI at any frequency range. This enables to exit from Stop mode directly at 48 MHz, without waiting for a PLL starting time.

### 3 Conclusion

The main features of the STM32L4xx devices are presented in this application note. They show the benefits offered by this microcontroller family to reduce the current consumption in embedded systems.

The STM32L4 and STM32L4+ Series extend the ST ultra-low power family already built with the STM32L0 and STM32L1 Series, offering high processing performance without compromising the power consumption. It complements the STM32 portfolio, keeping compatibility with other STM32 devices.

The rich set of peripherals of the STM32L4 and STM32L4+ Series cover a wide range of applications, while the available low power modes give full flexibility to adjust on-the-fly the consumption to any task.

This results in an extended operating lifetime for today's and tomorrow's always greener applications.

## 4 Revision history

**Table 9. Document revision history**

Date	Revision	Changes
21-Jul-2015	1	Initial release.
09-Feb-2017	2	<p>Updated <i>Introduction</i>, <i>Section 1: Energy-efficient processing</i>, <i>Section 2.1.2: Stop mode</i>, <i>Section 2.1.3: Standby mode</i>, <i>Section 2.1.4: Shutdown mode</i>, <i>Section 2.2: Multi-supply and battery backup domain</i>, <i>Section 2.3: Ultra-safe supply monitoring</i>, <i>Section 2.4: A set of peripherals tailored for low power</i> and <i>Section 2.5: A versatile clock management</i>.</p> <p>Updated title of <i>Figure 1: STM32L476 - Current consumption vs. system frequency (25 °C)</i>.</p> <p>Updated <i>Figure 2: Power distribution architecture</i>, <i>Figure 6: Low-power modes possible transitions</i> and <i>Figure 7: Power supply overview</i>.</p> <p>Updated <i>Table 6: STM32L4 modes overview</i> and its footnotes, and <i>Table 7: Features over all modes</i>.</p> <p>Added <i>Table 2: Performance comparison (mA/MHz) with system clock at 80 MHz</i> and <i>Table 4: Performance comparison (mA/MHz) for different Run modes</i>.</p>
27-Apr-2017	3	<p>Updated <i>Introduction</i>, <i>Section 2.2: Multi-supply and battery backup domain</i>, <i>Section 2.4: A set of peripherals tailored for low power</i> and <i>Section 2.5: A versatile clock management</i>.</p> <p>Updated <i>Table 2: Performance comparison (mA/MHz) with system clock at 80 MHz</i>, <i>Table 4: Performance comparison (mA/MHz) for different Run modes</i>, <i>Table 6: STM32L4 modes overview</i>, <i>Table 7: Features over all modes</i> and <i>Table 8: STM32L4xx clock source characteristics</i>.</p>

Table 9. Document revision history

Date	Revision	Changes
27-Mar-2018	4	<p>Added STM32L4+ Series, hence updated document title, <i>Introduction</i>, <i>Section 1: Energy-efficient processing</i>, <i>Section 2.2: Multi-supply and battery backup domain</i>, <i>Section 2.5: A versatile clock management</i> and <i>Section 3: Conclusion</i>.</p> <p>Updated <i>Figure 2: Power distribution architecture</i> and <i>Figure 7: Power supply overview</i>.</p> <p>Updated <i>Table 2: Performance comparison (mA/MHz) with system clock at 80 MHz</i>, <i>Table 4: Performance comparison (mA/MHz) for different Run modes</i>, and <i>Table 7: Features over all modes</i> and its footnotes.</p> <p>Added <i>Table 5: Number of wait states vs. CPU clock (HCLK) frequency, STM32L4+ Series</i>, <i>Figure 5: Flash memory latency vs. VCORE range, STM32L4+ Series</i> and footnote 1 to <i>Figure 2. Table 2.1.3: Standby mode</i></p>
16-Dec-2019	5	<p>Added STM32L4P5xx, STM32L4Q5xx and STM32L412 products, hence updated:</p> <ul style="list-style-type: none"> <li>– <i>Table 2: Performance comparison (mA/MHz) with system clock at 80 MHz</i></li> <li>– <i>Table 4: Performance comparison (mA/MHz) for different Run modes</i></li> <li>– <i>Table 6: STM32L4 modes overview</i></li> <li>– <i>Table 7: Features over all modes</i></li> <li>– <i>Section 2.1.3: Standby mode</i>.</li> </ul>

**IMPORTANT NOTICE – PLEASE READ CAREFULLY**

STMicroelectronics NV and its subsidiaries (“ST”) reserve the right to make changes, corrections, enhancements, modifications, and improvements to ST products and/or to this document at any time without notice. Purchasers should obtain the latest relevant information on ST products before placing orders. ST products are sold pursuant to ST’s terms and conditions of sale in place at the time of order acknowledgement.

Purchasers are solely responsible for the choice, selection, and use of ST products and ST assumes no liability for application assistance or the design of Purchasers’ products.

No license, express or implied, to any intellectual property right is granted by ST herein.

Resale of ST products with provisions different from the information set forth herein shall void any warranty granted by ST for such product.

ST and the ST logo are trademarks of ST. For additional information about ST trademarks, please refer to [www.st.com/trademarks](http://www.st.com/trademarks). All other product or service names are the property of their respective owners.

Information in this document supersedes and replaces information previously supplied in any prior versions of this document.

© 2019 STMicroelectronics – All rights reserved