

---

## Guidelines for meander design using low-cost PCB antennae with 2.4 GHz radio for STM32WB/WB0 MCUs

### Introduction

This application note is dedicated to the [STM32WB](#) and [STM32WB0](#) series microcontrollers.

One of the main reasons to use a printed circuit board (PCB) antenna is the reduced overall cost of the radio module. Well-designed and implemented PCB-printed antennae have a similar performance to the SMD (surface-mounted device) ceramic equivalence.

In general, the footprint for a ceramic SMD antenna is smaller than that for a PCB-printed variant. For a PCB-printed antenna solution, the increased size of the PCB in relation to the space required for the antenna means that the radio module is larger, increasing the cost of the PCB. However, the PCB solution is generally cheaper than an SMD ceramic antenna.

The demonstration and development boards for the STM32WB and STM32WB0 series implement PCB-printed antennae based on this application note.

## 1 General information

---

This document applies to STM32WB and STM32WB0 series Arm® based devices.

*Note:* Arm is a registered trademark of Arm Limited (or its subsidiaries) in the US and/or elsewhere.



## 2 Coordinate system

For the purpose of this document, the spherical coordinate system illustrated in the figure below is used.

Figure 1. Spherical coordinate system

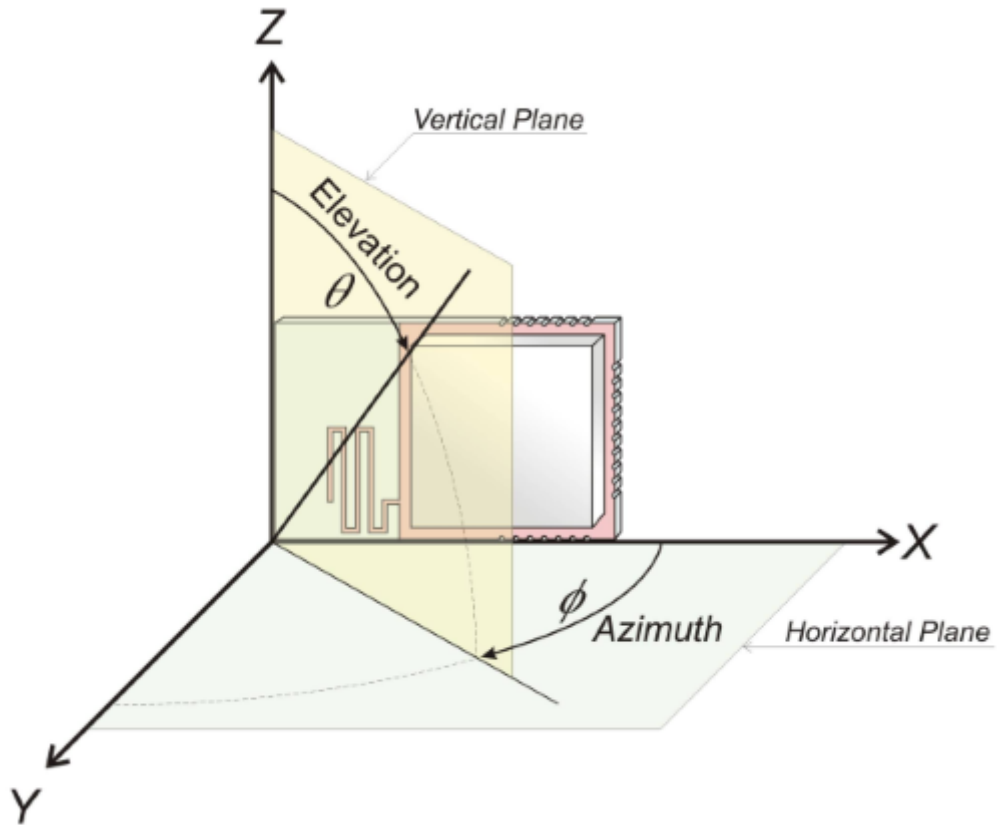

The PCB module is orientated vertically (plane X-Z) and located in proximity to the origin of the coordinate system. The azimuth angle radiates from the X-axis towards the Y-axis and the elevation angle radiates from the Z-axis towards the horizontal X-Y plane.

Sometimes, as with geographical and navigational systems, the X-axis is called the "Nord-axis", the Y-axis is called the "East-axis" and the Z-axis is called the "Zenith-axis".

### 3 Layout specification

The PCB antennas, including the electrical parameters of PCB materials used, are layout sensitive. It is recommended to use a layout as close as possible to the one shown in the figure below.

Figure 2. PCB antenna dimensions (in mm)

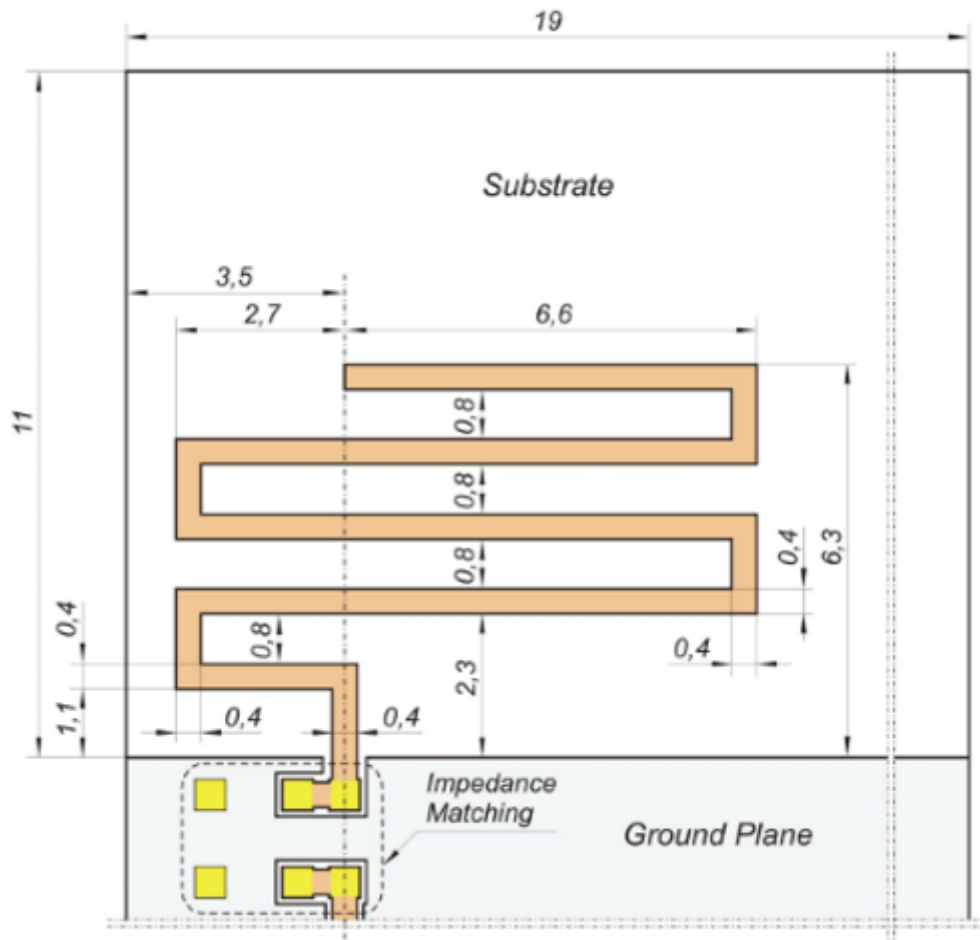

The electrical parameters and performance of the PCB antenna are also determined by the substrate used, in particular the thickness of the core and dielectric constants.

The figure below illustrates a typical cross-section of the substrate in a PCB-antennae area.

Figure 3. PCB cross section at antennae area

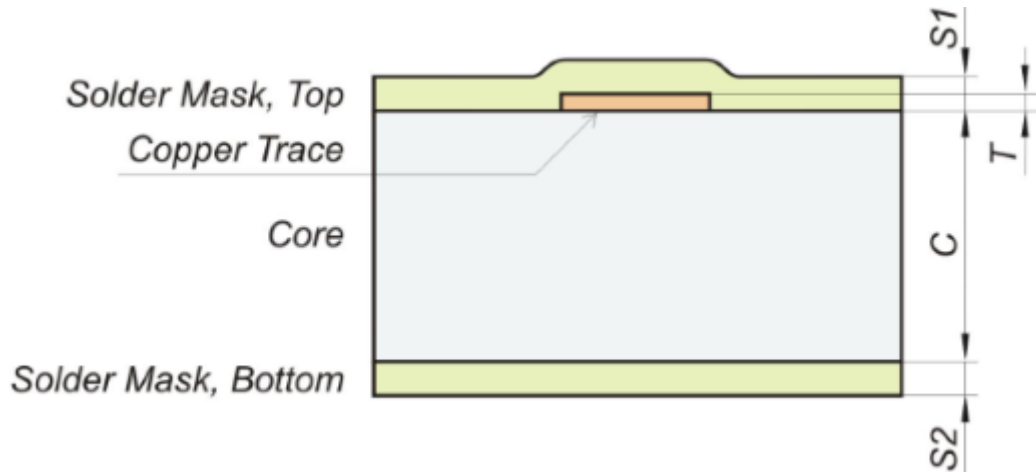

A substrate with the parameters as defined in the table below is recommended.

Table 1. Recommended substrate specification

Layer	Dimensions			Dielectric constant $\epsilon_R$
	Label	Value (mil)	Value ( $\mu\text{m}$ )	
Solder mask, top	S1	0.7	17.78	4.4
Copper trace	T	1.6	40.64	-
Core	C	28	711.2	4.4
Solder mask, bottom	S2	0.7	17.78	4.4

## 4 Impedance matching

Meander-like PCB antennae can be tuned to the required 50-Ω impedance by matching the impedance circuitry with the  $\pi$  topology. In Figure 2, the impedance matching area is marked with a dashed line. Under nominal conditions, this antenna exhibits an impedance very close to the required nominal impedance (50 Ω).

To check the performance of this design, a sample antenna was manufactured (according to the specifications covered by this document). The figure below shows this antenna.

**Figure 4. Part of 802.15.4 and BLE PCB with meander-like antenna (scale approximately 4:1)**



Assuming that the manufactured sample exhibits the expected performance (no impedance matching necessary), the impedance matching circuitry is bypassed by two 100-pF capacitors connected in series, as shown in the figure below.

**Figure 5. Bypassing impedance matching circuitry - Direct RF connection**

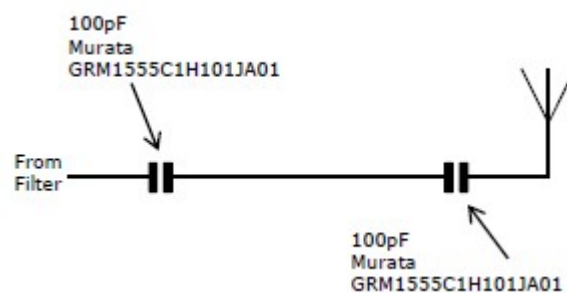

All electrical parameters of the meander-like antenna have been measured at connection to the band-pass filter (BPF) with the frequency span covering frequencies from 2.4 GHz to 2.5 GHz.

The figure below shows the complex impedance of the antenna in a Smith chart.

**Figure 6. Complex impedance of the meander-like antenna (Smith chart)**

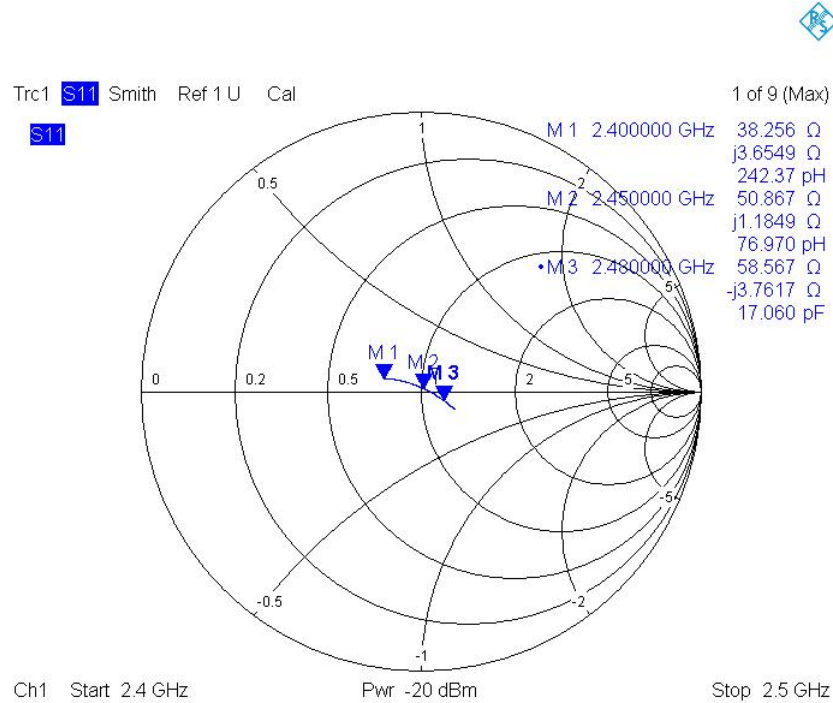

The figure below shows the magnitude of the S11 parameter (in log scale).

**Figure 7. S11 parameter in logarithmic scale (Cartesian plot)**

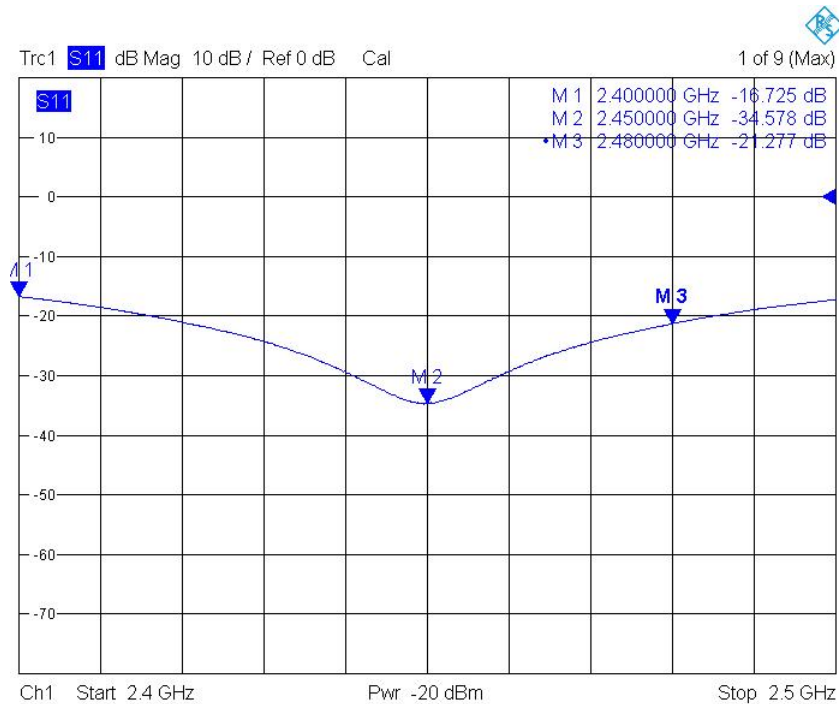

The figure below shows the standing wave ratio (SWR).

Figure 8. Antenna standing wave ratio (SWR)

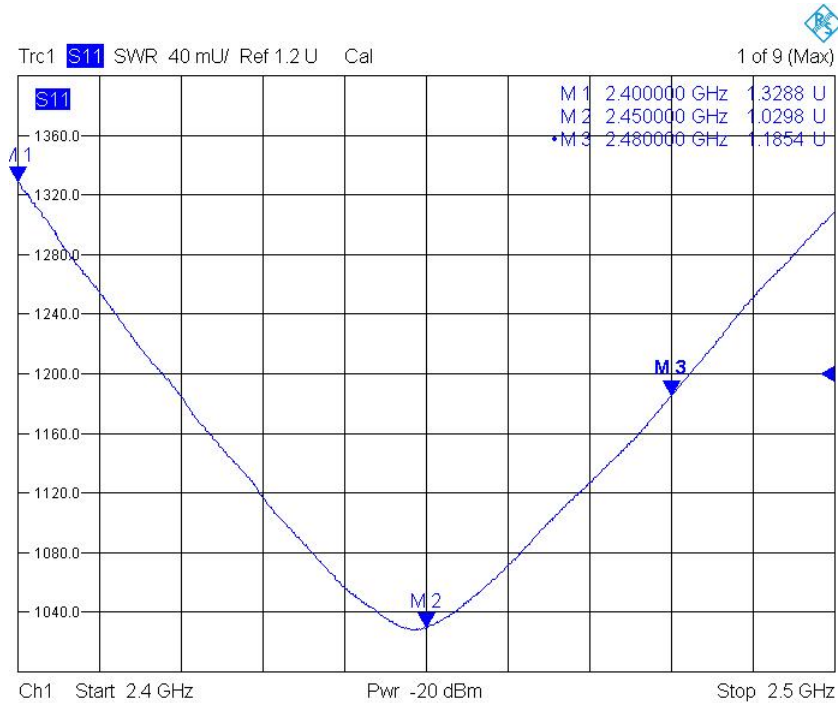

The following changes affect the radiation impedance of the PCB antenna:

- Board size variation
- Metal shielding
- Use of plastic cover
- Presence of other components in proximity of the antenna

The best performance impedance matching circuitry compensates these effects so that, for operating frequencies, the optimum 50-Ω impedance is achieved.



## 5 Radiation pattern, 3-D visualization

A three-dimensional (3-D) visualization of the radiation pattern (magnitude of the electrical far field  $|E|$ ) is done for the center ISM band frequency 2.44175 GHz.

**Figure 9. 3-D radiation pattern overview**

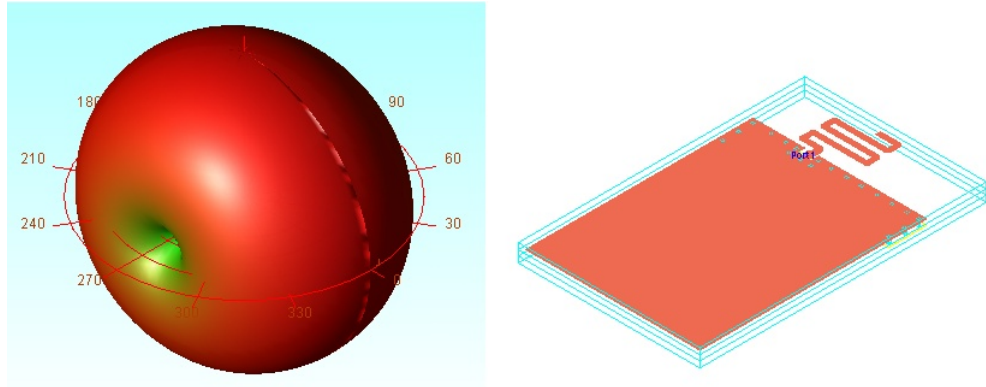

**Figure 10. Radiation pattern on X-Z plane**

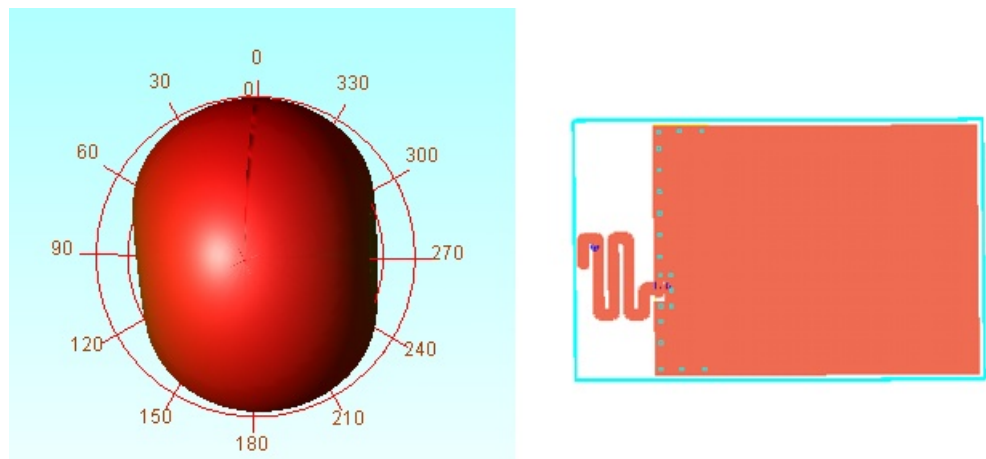

## 6 Radiation pattern, 2-D visualization

In this section, all radiation patterns are related to the magnitude of the electrical far field  $|E|$ , which is normalized and shown in the logarithmic scale (in dB). This means that the maximum global radiation pattern (maximum magnitude of the electrical far-field  $|E|$ ) is represented by a 0 dB level.

To show the antenna radiation patterns in detail, three two-dimensional (2-D) major cuts are presented. Consider the orientation of the module in the spherical coordinate system as shown in Figure 1.

A three-dimensional (3-D) far field radiation pattern is visualized as three 2-D cuts through a 3-D pattern. The following major planes are used for these cuts (see Figure 11):

- One horizontal X-Y plane
- Two vertical planes: X-Z plane and Y-Z plane

The colors of the plots in the figure below are as follows:

- The blue plot is drawn on the horizontal X-Y plane, where azimuth  $\phi$  radiates from  $0^\circ$  on the X-axis towards the Y-axis, until it reaches  $360^\circ$  on the X-axis.
- The red plot is drawn on the X-Z plane, where elevation  $\theta$  radiates from  $0^\circ$  on the Z-axis towards the positive part of the X-axis, until it reaches  $180^\circ$  on the negative part of the Z-axis. In this plot (cut by X-Z plane), elevation  $\theta$  is negative for  $X < 0$ .
- The green plot is drawn on the Y-Z plane, where elevation  $\theta$  radiates from  $0^\circ$  on the Z-axis towards the positive part of the Y-axis, until it reaches  $180^\circ$  on the negative part of the Z-axis. For this plot (cut by Y-Z plane), elevation  $\theta$  is negative for  $Y < 0$ .

Figure 11. Major planes to visualize 3-D radiation pattern using 2-D plots

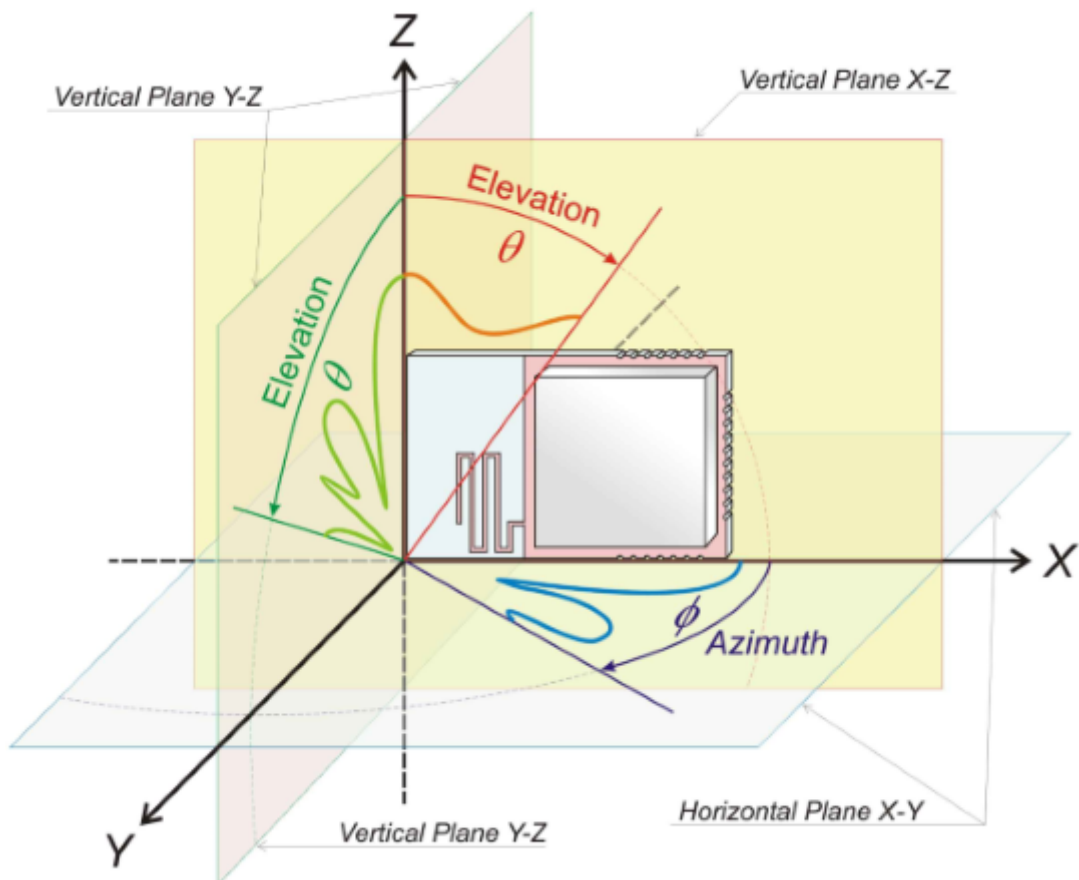

This section uses short dipole for comparison and clarification purposes only.

## 6.1 Radiation pattern on Y-Z plane

The first radiation patterns in Figure 13 and Figure 14 show a normal electrical field radiation pattern  $|E|$  (far field) on the Y-Z plane. The module orientation versus Y-Z plane and this plot is shown in the figure below.

**Figure 12. Far field radiation pattern plotted on Y-Z plane**

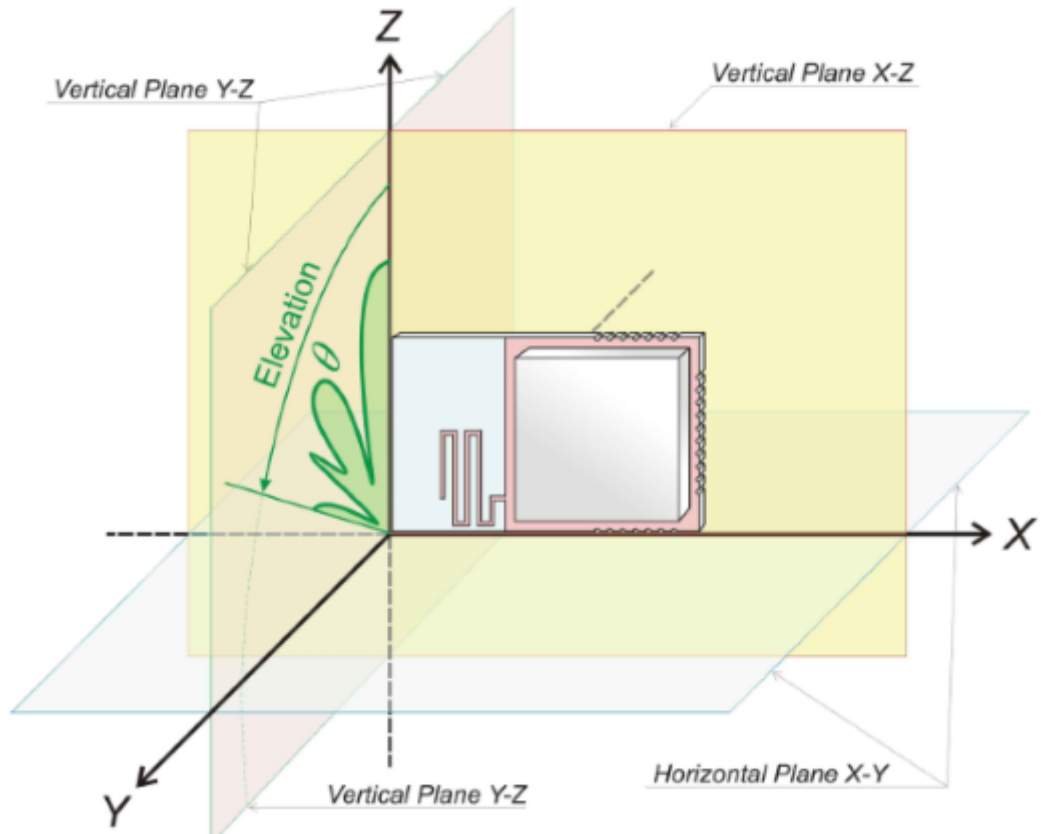

*Note: The level of the radiation is nearly constant and the radiation is nearly omni-directional on this plane. For a vertically orientated dipole, this pattern is equivalent to the horizontal radiation.*

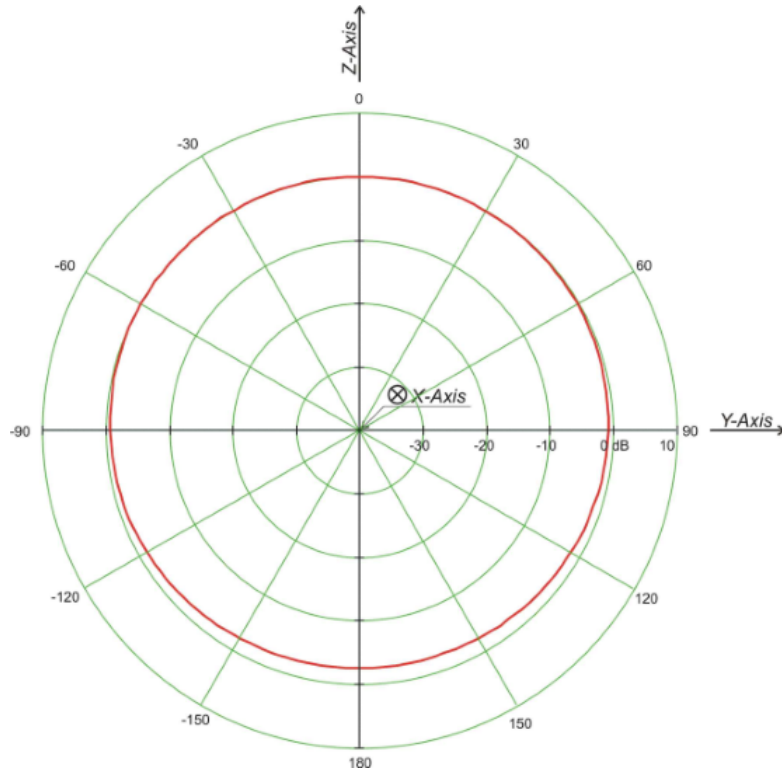
**Figure 13. Normalized radiation pattern on Y-Z plan (polar plot)**

The figure below shows the same radiation pattern as in the previous figure, presented as a Cartesian plot.

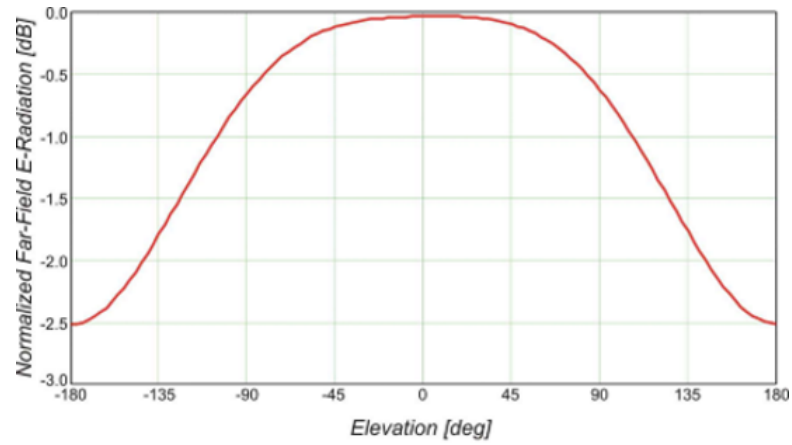
**Figure 14. Normalized radiation pattern on Y-Z plan (Cartesian plot)**

## 6.2 Radiation pattern on X-Y plane

The second far-field radiation patterns in Figure 16 and Figure 17 represent a normalized magnitude of the electrical field  $|E|$  plotted on the X-Y plane. The module orientation versus the X-Y plane and this plot is shown in the figure below.

Figure 15. Far field radiation pattern plotted on X-Y plane

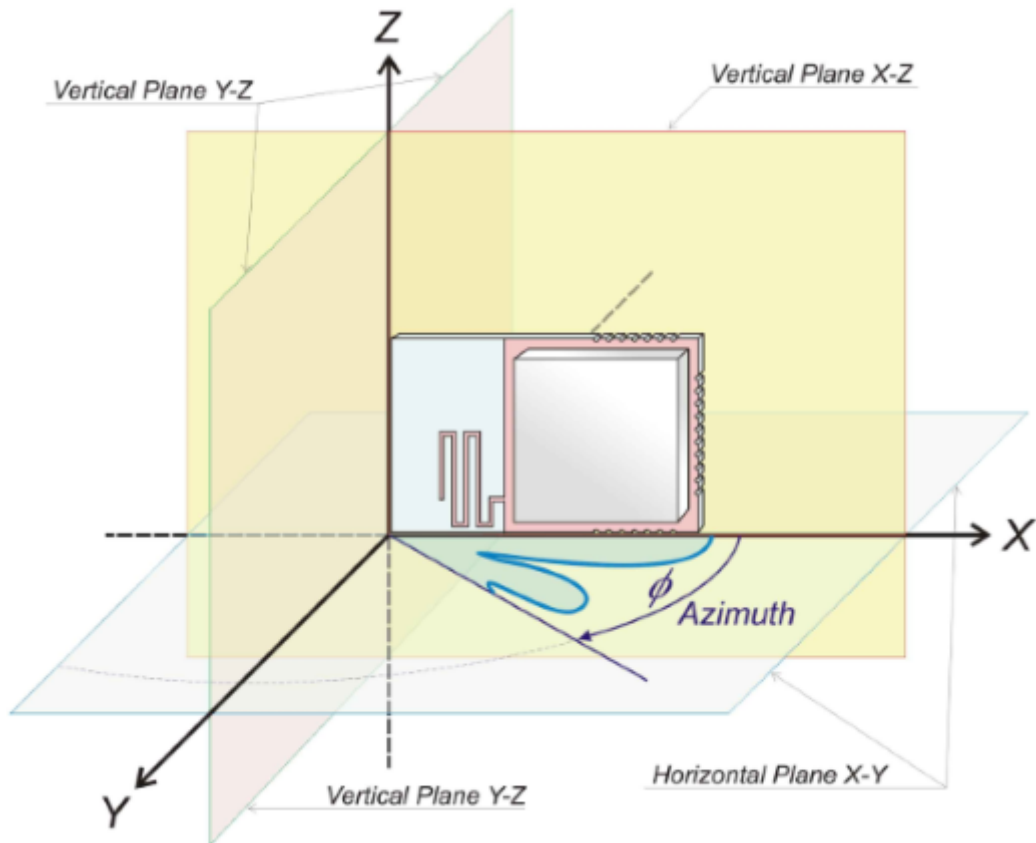

For a vertically orientated dipole, this pattern is equivalent to the vertical radiation.

Note that this solution does not present blind direction as a standard dipole does when the receiver is in the Z-axis of the dipole antenna. In this solution, the maximum attenuation is in the range of 10 to 14 dB in the X-Y direction.

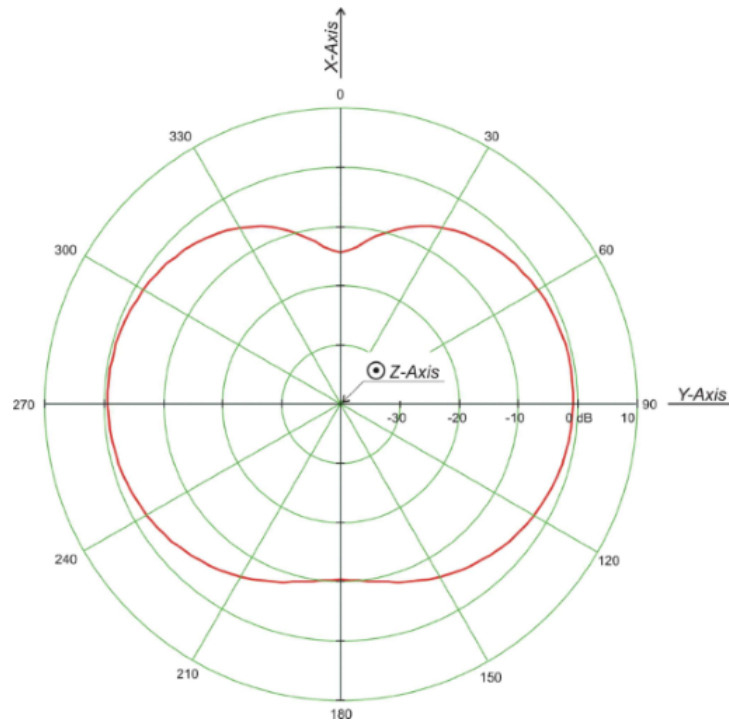
**Figure 16. Normalized radiation pattern on X-Y plan (polar plot)**

The figure below shows the same far  $|E|$ -field radiation pattern on the X-Y plane as in the previous figure, presented as a Cartesian plot.

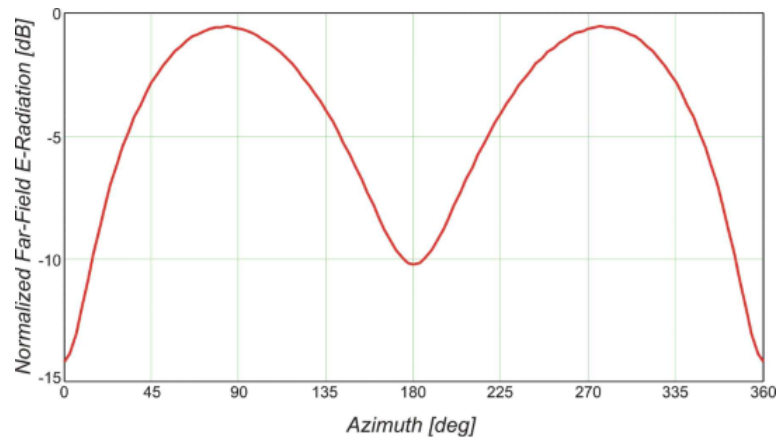
**Figure 17. Normalized radiation pattern on X-Y plan (Cartesian plot)**

### 6.3 Radiation pattern on X-Z plane

The third and last radiation patterns in Figure 19 and Figure 20 represent a normalized electrical field radiation pattern  $|E|$  (far field) on the X-Z plane. The figure below shows the module orientation against the X-Z plane and this plot.

Figure 18. Far field radiation pattern plotted on X-Z plane

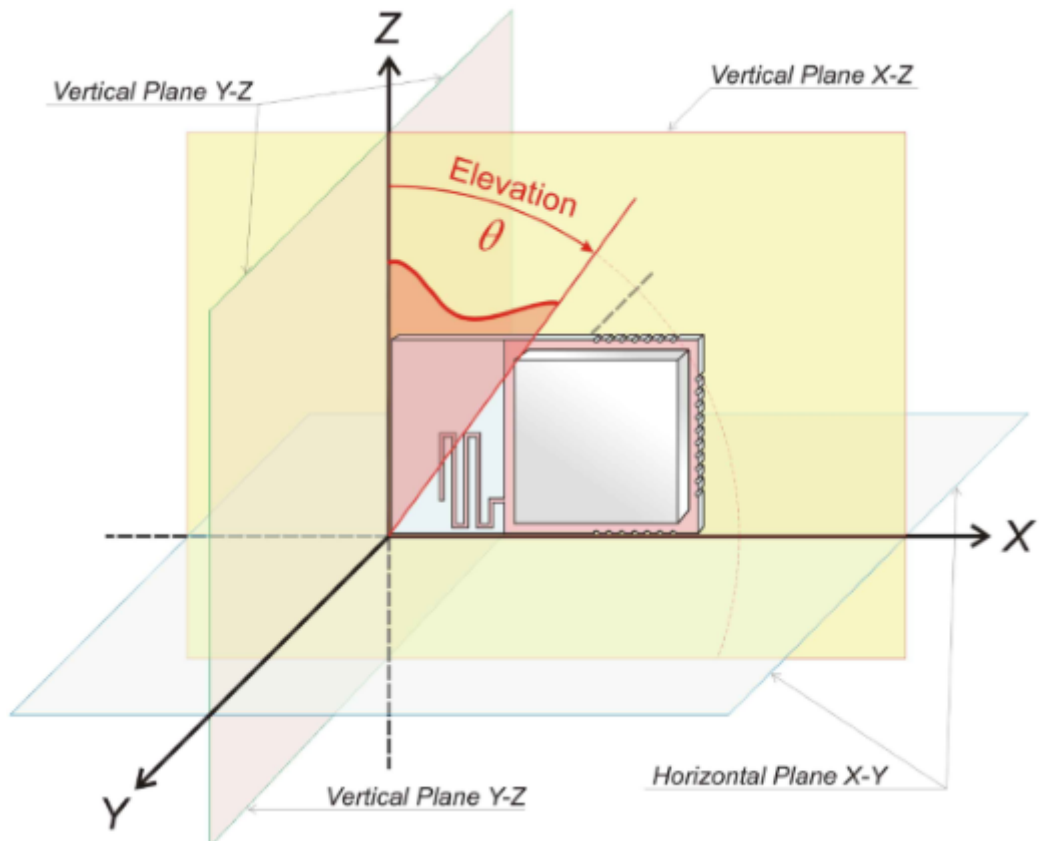

For a horizontally orientated dipole, this pattern is equivalent to the vertical radiation.

**Figure 19. Normalized radiation pattern on X-Z plan (polar plot)**

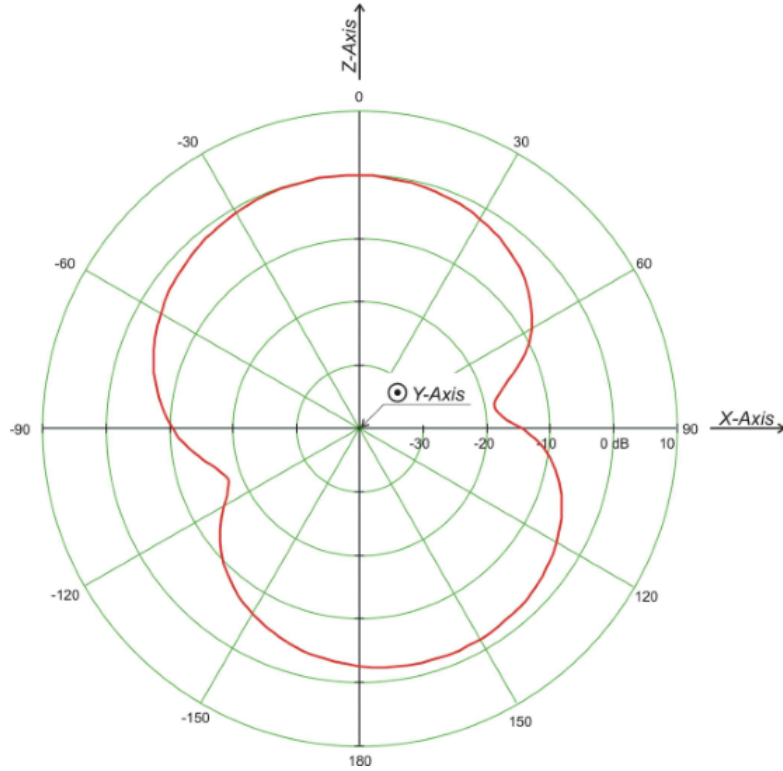

The figure below shows the same far electrical field radiation pattern on the X-Z plane in the previous figure, presented as a Cartesian plot.

**Figure 20. Normalized radiation pattern on X-Z plan (Cartesian plot)**

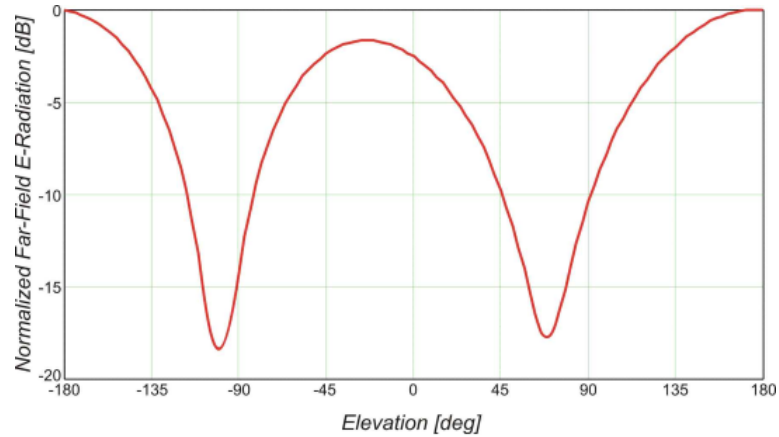



---

## 7 Performance

---

At center ISM band frequency 2.44175 GHz, the antenna shows the following key performance parameters:

- Directivity: 2.21 dB
- Gain: 1.95 dBi
- Maximum intensity: 0.125 W/steradian

## 8 Mechanical and PCB impact

---

The integration of this type of antenna in a final product can be degraded if the ground plane is too close. Enough room must be left around the antenna without the ground plane.

*Note: Any metallic object impacts the performance of the antenna and radiation pattern. Similarly, if the device is hand-operated, the hand and body position of the user may impact the antenna design*

## Revision history

**Table 2. Document revision history**

Date	Version	Changes
17-Jan-2018	1	Initial release
14-Sep-2018	2	Updated document's publishing scope
25-Feb-2019	3	Updated document's publishing scope
23-Apr-2019	4	Updated <a href="#">Figure 2. PCB antenna dimensions (in mm)</a>
12-Apr-2024	5	Updated: <ul style="list-style-type: none"> <li>• <a href="#">Document title</a></li> <li>• <a href="#">Section Introduction</a></li> <li>• <a href="#">Section 1: General information</a></li> </ul> General document cleanup.

## Contents

<b>1</b>	<b>General information</b> .....	<b>2</b>
<b>2</b>	<b>Coordinate system</b> .....	<b>3</b>
<b>3</b>	<b>Layout specification</b> .....	<b>4</b>
<b>4</b>	<b>Impedance matching</b> .....	<b>6</b>
<b>5</b>	<b>Radiation pattern, 3-D visualization</b> .....	<b>9</b>
<b>6</b>	<b>Radiation pattern, 2-D visualization</b> .....	<b>10</b>
<b>6.1</b>	Radiation pattern on Y-Z plane .....	11
<b>6.2</b>	Radiation pattern on X-Y plane .....	13
<b>6.3</b>	Radiation pattern on X-Z plane .....	15
<b>7</b>	<b>Performance</b> .....	<b>17</b>
<b>8</b>	<b>Mechanical and PCB impact</b> .....	<b>18</b>
	<b>Revision history</b> .....	<b>19</b>
	<b>List of figures</b> .....	<b>21</b>

## List of figures

<b>Figure 1.</b>	Spherical coordinate system. . . . .	3
<b>Figure 2.</b>	PCB antenna dimensions (in mm) . . . . .	4
<b>Figure 3.</b>	PCB cross section at antennae area . . . . .	5
<b>Figure 4.</b>	Part of 802.15.4 and BLE PCB with meander-like antenna (scale approximately 4:1) . . . . .	6
<b>Figure 5.</b>	Bypassing impedance matching circuitry - Direct RF connection . . . . .	6
<b>Figure 6.</b>	Complex impedance of the meander-like antenna (Smith chart) . . . . .	7
<b>Figure 7.</b>	S11 parameter in logarithmic scale (Cartesian plot) . . . . .	7
<b>Figure 8.</b>	Antenna standing wave ratio (SWR) . . . . .	8
<b>Figure 9.</b>	3-D radiation pattern overview . . . . .	9
<b>Figure 10.</b>	Radiation pattern on X-Z plane . . . . .	9
<b>Figure 11.</b>	Major planes to visualize 3-D radiation pattern using 2-D plots . . . . .	10
<b>Figure 12.</b>	Far field radiation pattern plotted on Y-Z plane . . . . .	11
<b>Figure 13.</b>	Normalized radiation pattern on Y-Z plan (polar plot) . . . . .	12
<b>Figure 14.</b>	Normalized radiation pattern on Y-Z plan (Cartesian plot) . . . . .	12
<b>Figure 15.</b>	Far field radiation pattern plotted on X-Y plane . . . . .	13
<b>Figure 16.</b>	Normalized radiation pattern on X-Y plan (polar plot) . . . . .	14
<b>Figure 17.</b>	Normalized radiation pattern on X-Y plan (Cartesian plot) . . . . .	14
<b>Figure 18.</b>	Far field radiation pattern plotted on X-Z plane . . . . .	15
<b>Figure 19.</b>	Normalized radiation pattern on X-Z plan (polar plot) . . . . .	16
<b>Figure 20.</b>	Normalized radiation pattern on X-Z plan (Cartesian plot) . . . . .	16

**IMPORTANT NOTICE – READ CAREFULLY**

STMicroelectronics NV and its subsidiaries (“ST”) reserve the right to make changes, corrections, enhancements, modifications, and improvements to ST products and/or to this document at any time without notice. Purchasers should obtain the latest relevant information on ST products before placing orders. ST products are sold pursuant to ST’s terms and conditions of sale in place at the time of order acknowledgment.

Purchasers are solely responsible for the choice, selection, and use of ST products and ST assumes no liability for application assistance or the design of purchasers’ products.

No license, express or implied, to any intellectual property right is granted by ST herein.

Resale of ST products with provisions different from the information set forth herein shall void any warranty granted by ST for such product.

ST and the ST logo are trademarks of ST. For additional information about ST trademarks, refer to [www.st.com/trademarks](http://www.st.com/trademarks). All other product or service names are the property of their respective owners.

Information in this document supersedes and replaces information previously supplied in any prior versions of this document.

© 2024 STMicroelectronics – All rights reserved