

VN9006AJ evaluation board

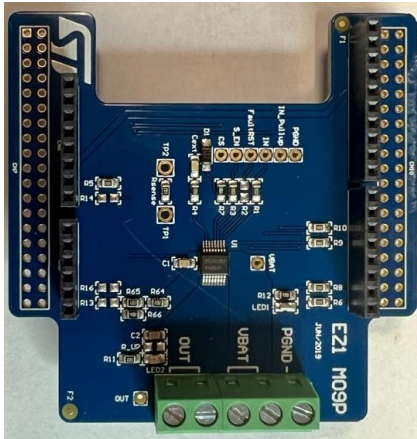

Product status link

[EV-VN9006AJ](#)

Product summary

Order code	EV-VN9006AJ
------------	-------------

Features

Max transient supply voltage	V_{CC}	36 V
Operating voltage range	V_{CC}	4 to 28 V
Typ. on-state resistance (per Ch)	R_{ON}	6 m Ω
Current limitation (typ.)	I_{LIMH}	82 A
Standby current (max.)	I_{STBY}	0.5 μ A

- Extreme low voltage operation for deep cold cranking applications (compliant with LV124, revision 2013)
- General
 - Single channel smart high-side driver with current sense analog feedback
 - Very low standby current
 - Compatible with 3 V and 5 V CMOS outputs
- Current sense diagnostic functions
 - Multiplexed analog feedback of load current with high precision proportional current mirror
 - Overload and short to ground (power limitation) indication
 - Thermal shutdown indication
 - OFF-state open-load detection (with external pull-up)
 - Output short to V_{CC} detection
 - Sense enable/disable
- Protections
 - Undervoltage shutdown
 - Overvoltage clamp
 - Load current limitation
 - Self limiting of fast thermal transients
 - Configurable latch-off on overtemperature or power limitation with dedicated fault reset pin
 - Loss of ground and loss of V_{CC}
 - Reverse battery through self turn-on
 - Electrostatic discharge protection

Applications

- Automotive resistive, inductive and capacitive loads.
- Protected supply for ADAS systems: radars and sensors.

Description

The EV-VN9006AJ board provides an easy way to connect VN9006AJ into the existing system.

1 Overview

The EV-VN9006AJ comes pre-assembled with VN9006AJ high-side driver. On board minimum set of electrical components (as for device datasheet recommendation) enables the user to directly connect the load, the power supply and the microcontroller without any additional effort in external component design and connection.

The VN9006AJ is a single channel high-side driver manufactured using ST proprietary VIPower M0-9 technology and housed in a PowerSSO-16 package. The device is designed to drive 12 V automotive grounded loads through a 3 V and 5 V CMOS compatible interface, providing protection and diagnostics.

The device integrates advanced protective functions such as load current limitation, overload active management by power limitation and overtemperature shutdown with configurable latch-off.

A FaultRST pin unlatches the output in case of fault or disables the latch-off functionality. A dedicated multifunction multiplexed analog output pin delivers sophisticated diagnostic functions including high precision proportional load current sense, supply voltage feedback and chip temperature sense, in addition to the detection of overload and short circuit to ground, short to VCC and OFF-state open-load.

Figure 1. Board schematics

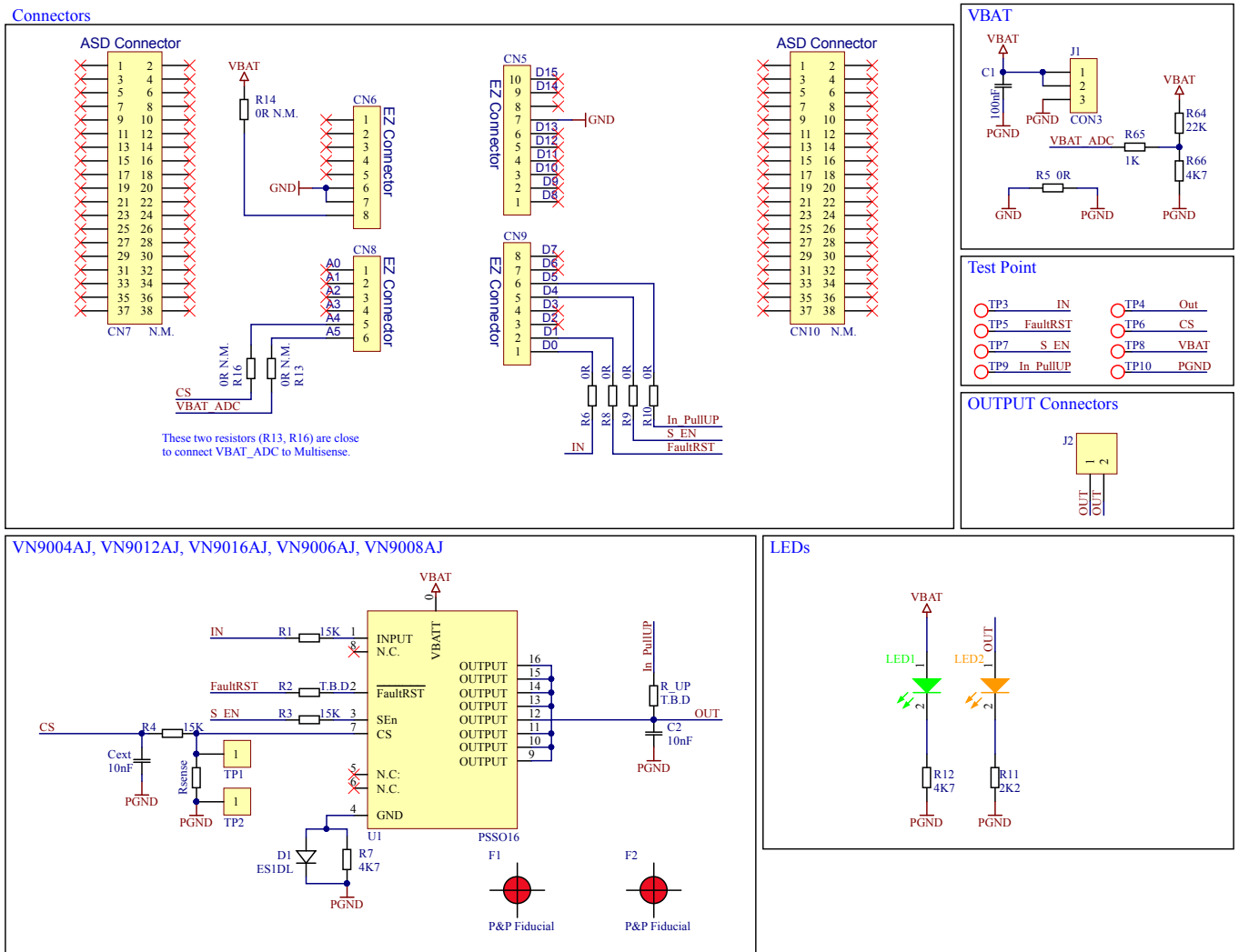

2 Board connections

The Figure 2 shows the placement of the connectors to be used for supplying the evaluation board, connecting the load, and controlling the functionality and diagnostic of the device.

Figure 2. Evaluation board connections

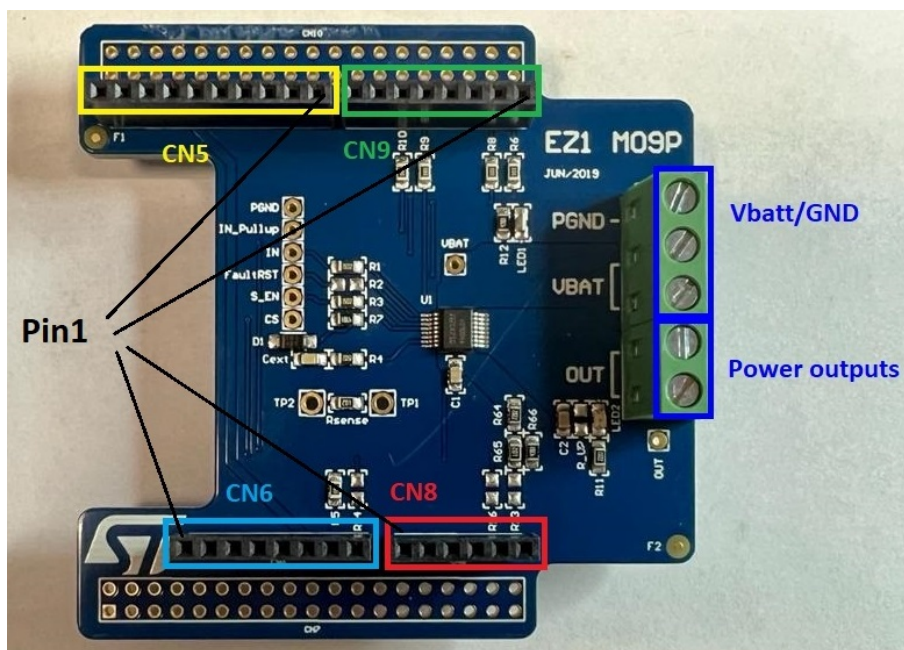

Table 1. CN connectors: pin functions

Pin number	Connector	Pin function
7	CN5	GND
6	CN6	GND
7	CN6	GND
5	CN8	MultiSense
6	CN8	VBAT_ADC
1	CN9	IN
2	CN9	FaultRST
5	CN9	SEn
6	CN9	In_PullUP

Revision history

Table 2. Document revision history

Date	Revision	Changes
01-Mar-2023	1	Initial release.

IMPORTANT NOTICE – READ CAREFULLY

STMicroelectronics NV and its subsidiaries (“ST”) reserve the right to make changes, corrections, enhancements, modifications, and improvements to ST products and/or to this document at any time without notice. Purchasers should obtain the latest relevant information on ST products before placing orders. ST products are sold pursuant to ST’s terms and conditions of sale in place at the time of order acknowledgment.

Purchasers are solely responsible for the choice, selection, and use of ST products and ST assumes no liability for application assistance or the design of purchasers’ products.

No license, express or implied, to any intellectual property right is granted by ST herein.

Resale of ST products with provisions different from the information set forth herein shall void any warranty granted by ST for such product.

ST and the ST logo are trademarks of ST. For additional information about ST trademarks, refer to www.st.com/trademarks. All other product or service names are the property of their respective owners.

Information in this document supersedes and replaces information previously supplied in any prior versions of this document.

© 2023 STMicroelectronics – All rights reserved