



ST32F256-M

M2M MCU with 32-bit ARM Cortex™ M3 CPU and 256 Kbyte high-density Flash memory

Data brief

Features

Hardware features

- ARM Cortex™-M3 32-bit RISC core
- 8 Kbytes of user RAM
- 256 Kbytes of user Flash memory with OTP area:
 - 10-year data retention at 105°C, or 15 years at 85°C
 - 500,000 Erase/Write cycles per page
 - 50 million Erase/Write cycles per 64 Kbyte sector
 - Page granularity of 128 Bytes
 - Block granularity: 1 Kbyte
 - 128 Bytes of OTP for user
 - Page Erase time 4 ms
 - Block Erase 1 Kbyte in 20 ms
 - Programming performance up to 10µs/byte
 - Flash Erase / Write Protection software programmable on 64 Kbyte sectors
- Asynchronous Receiver Transmitter supporting ISO 7816-3 T=0 and T=1 protocols
- Two 16-bit timers with interrupt capability
- 1.8V, 3V and 5V supply voltage ranges
- External clock frequency from 1 up to 7.5 MHz
- High performance provided by:
 - CPU clock frequency up to 15 MHz
 - External clock multiplier (2x, 3x, and 4x)
- Current consumption compatible with GSM and ETSI specifications
- Power-saving Standby state
- Contact assignment compatible ISO 7816-2
- ESD protection greater than 4 kV (HBM)
- 8-pin DFN (6 x 5 mm) ECOPACK® package

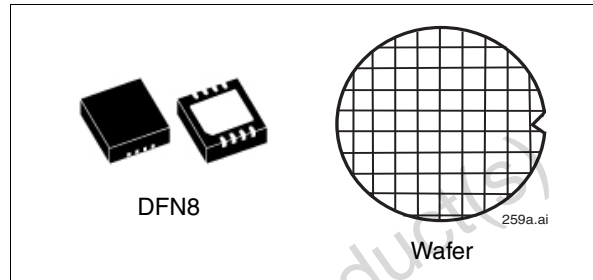

Security features

- Monitoring of environmental parameters
- Protection against faults
- ISO 3309 CRC calculation block
- True random number generator
- Unique serial number on each die
- Hardware data encryption standard (DES) accelerator

Software features

- Flash loader
- Flash drivers

Development environment

- Software development and firmware generation are supported by a comprehensive set of development tools dedicated to software design and validation:
 - C compiler
 - Simulator
 - Emulator

Description

The ST32F256-M is designed for machine-to-machine (M2M) applications. Its Cortex™-M3 32-bit RISC core operating at a 15-MHz frequency provides great performance and excellent code compacity.

1 Functional description

1.1 Hardware description

The ST32F256-M is a serial access microcontroller designed for machine-to-machine (M2M) applications that incorporates the most recent generation of ARM processors for embedded systems. Its Cortex™-M3 32-bit RISC core operating at a 15-MHz frequency brings great performance and excellent code compacity to the application thanks to the Thumb®-2 instruction set.

The high-speed embedded Flash 256 Kbyte memory introduces more flexibility to the system.

The ST32F256-M also offers a serial communication interface fully compatible with the ISO 7816-3 standard (T=0, T=1) for smartcard applications.

Two general purpose 16-bit timers are available.

A hardware Data Encryption Standard (DES) accelerator can be used to the user to optimize the application performance. A software library is provided for Advanced Encryption Standard (AES) implementation.

The ST32F256-M operates in the -40 to +105°C temperature range and 1.8 V, 3 V and 5 V supply voltage ranges. A comprehensive range of power-saving modes enables the design of efficient low-power applications.

Figure 1. ST32F256-M block diagram

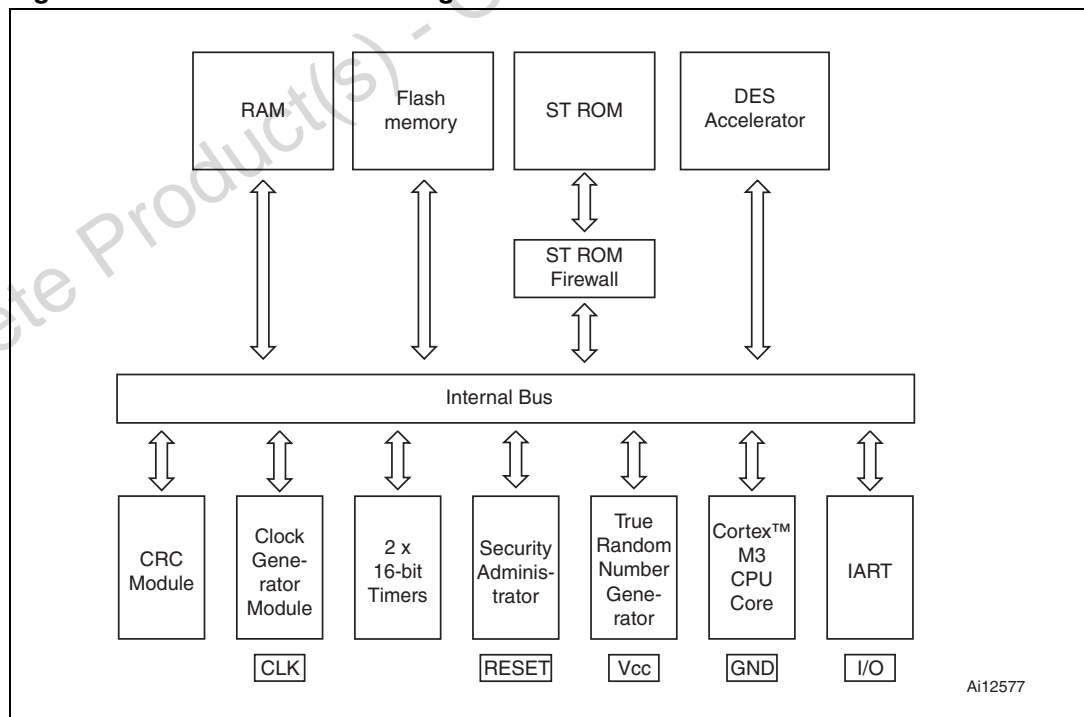

1.2 Package features

Package qualification for M2M applications:

- Moisture Sensitivity Level test according to IPC/JEDEC J-STD-20: MSL1 with 260 °C peak temperature.
- Temperature Humidity Bias test according to JEDEC JESD22-A101: 85 °C, 85% RH, 1000 hours.
- Autoclave test according to JEDEC JESD22-A102: 121°C, 100% RH, 205 kPa, 96 hours.
- Vibration test according to JEDEC JESD22-B103 service condition 1: 20 / 2000 Hz, 20 g peak acceleration.
- Mechanical Shock test according to JEDEC JESD22-B104 service condition B: 1500 g acceleration for 0.5 ms pulse duration.
- Temperature cycling test according to JEDEC JESD22-A104: –65 / +150 °C, 500 cycles.

In order to meet environmental requirements, ST offers these devices in different grades of ECOPACK® packages, depending on their level of environmental compliance. ECOPACK® specifications, grade definitions and product status are available at: www.st.com. ECOPACK® is an ST trademark.

1.3 Software development tools description

Dedicated Cortex™-M3 software development tools are provided by ARM and Keil. This includes the Instruction Set Simulator (ISS) and C compiler. The documentation is available on the ARM and Keil web sites.

Moreover, STMicroelectronics provides:

- A time-accurate hardware emulator controlled by the Keil debugger and the ST development environment.
- A complete product simulator based on Keil's ISS simulator for the Cortex™-M3 CPU.
- A ROMed Flash Loader with very high-speed software downloading capabilities.

2 Revision history

Table 1. Document revision history

Date	Revision	Changes
02-Nov-2009	1	Initial release.
23-Feb-2010	2	Updated Page Erase and Block Erase times.
07-Jul-2010	3	Updated Features on page 1.

Please Read Carefully:

Information in this document is provided solely in connection with ST products. STMicroelectronics NV and its subsidiaries ("ST") reserve the right to make changes, corrections, modifications or improvements, to this document, and the products and services described herein at any time, without notice.

All ST products are sold pursuant to ST's terms and conditions of sale.

Purchasers are solely responsible for the choice, selection and use of the ST products and services described herein, and ST assumes no liability whatsoever relating to the choice, selection or use of the ST products and services described herein.

No license, express or implied, by estoppel or otherwise, to any intellectual property rights is granted under this document. If any part of this document refers to any third party products or services it shall not be deemed a license grant by ST for the use of such third party products or services, or any intellectual property contained therein or considered as a warranty covering the use in any manner whatsoever of such third party products or services or any intellectual property contained therein.

UNLESS OTHERWISE SET FORTH IN ST'S TERMS AND CONDITIONS OF SALE ST DISCLAIMS ANY EXPRESS OR IMPLIED WARRANTY WITH RESPECT TO THE USE AND/OR SALE OF ST PRODUCTS INCLUDING WITHOUT LIMITATION IMPLIED WARRANTIES OF MERCHANTABILITY, FITNESS FOR A PARTICULAR PURPOSE (AND THEIR EQUIVALENTS UNDER THE LAWS OF ANY JURISDICTION), OR INFRINGEMENT OF ANY PATENT, COPYRIGHT OR OTHER INTELLECTUAL PROPERTY RIGHT.

UNLESS EXPRESSLY APPROVED IN WRITING BY AN AUTHORIZED ST REPRESENTATIVE, ST PRODUCTS ARE NOT RECOMMENDED, AUTHORIZED OR WARRANTED FOR USE IN MILITARY, AIR CRAFT, SPACE, LIFE SAVING, OR LIFE SUSTAINING APPLICATIONS, NOR IN PRODUCTS OR SYSTEMS WHERE FAILURE OR MALFUNCTION MAY RESULT IN PERSONAL INJURY, DEATH, OR SEVERE PROPERTY OR ENVIRONMENTAL DAMAGE. ST PRODUCTS WHICH ARE NOT SPECIFIED AS "AUTOMOTIVE GRADE" MAY ONLY BE USED IN AUTOMOTIVE APPLICATIONS AT USER'S OWN RISK.

Resale of ST products with provisions different from the statements and/or technical features set forth in this document shall immediately void any warranty granted by ST for the ST product or service described herein and shall not create or extend in any manner whatsoever, any liability of ST.

ST and the ST logo are trademarks or registered trademarks of ST in various countries.

Information in this document supersedes and replaces all information previously supplied.

The ST logo is a registered trademark of STMicroelectronics. All other names are the property of their respective owners.

© 2010 STMicroelectronics - All rights reserved

STMicroelectronics group of companies

Australia - Belgium - Brazil - Canada - China - Czech Republic - Finland - France - Germany - Hong Kong - India - Israel - Italy - Japan - Malaysia - Malta - Morocco - Philippines - Singapore - Spain - Sweden - Switzerland - United Kingdom - United States of America

www.st.com