

0.8 A 400 V high immunity sensitive SCR thyristor in TO-92

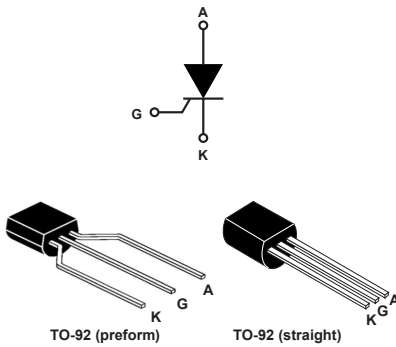

Features

- On-state rms current, $I_{T(RMS)}$ 0.8 A
- 125 °C max. T_j
- Low 0.2 mA gate current
- Repetitive peak off-state voltage, V_{DRM}/V_{RRM} 400 V
- ECOPACK2 compliant

Applications

- Gate driver for large Thyristors
- Overvoltage crowbar protection
- Ground fault circuit interrupters
- Arc fault circuit interrupter
- Standby mode power supplies
- Residual current detector

Product status link

[P0102DA](#)

Product summary

$I_{T(RMS)}$	0.8 A
V_{DRM}/V_{RRM}	400 V
I_{GT}	0.2 mA
$T_{jmax.}$	125 °C

Description

Thanks to highly sensitive triggering levels, the 0.8 A **P0102DA** SCR thyristor is suitable for all applications where available gate current is limited.

This device offers a high blocking voltage of 400 V, ideal for applications like interrupters circuits.

The **P0102DA** is available in through-hole TO-92 package.

1 Characteristics

Table 1. Absolute maximum ratings (limiting values)

Symbol	Parameters		Value	Unit	
$I_{T(RMS)}$	On-state RMS current (180° conduction angle)		0.8	A	
$I_{T(AV)}$	Average on-state current (180° conduction angle)				
I_{TSM}	Non repetitive surge peak on-state current, T_j initial = 25 °C	$t_p = 8.3$ ms	8	A	
		$t_p = 10$ ms			
I^2t	I^2t value for fusing	$t_p = 10$ ms	$T_j = 25$ °C	0.24	A ² s
di/dt	Critical rate of rise of on-state current $I_G = 2 \times I_{GT}$, $t_r \leq 100$ ns	F = 60 Hz	$T_j = 25$ °C	50	A/ μ s
V_{DRM} / V_{RRM}	Repetitive peak off-state voltage		$T_j = 125$ °C	400	V
I_{GM}	Peak gate current	$t_p = 20$ μ s	$T_j = 125$ °C	1	A
$P_{G(AV)}$	Average gate power dissipation		$T_j = 125$ °C	0.1	W
T_{stg}	Storage junction temperature range			-40 to +150	°C
T_j	Operating junction temperature range			-40 to +125	°C

Table 2. Electrical characteristics ($T_j = 25$ °C, unless otherwise specified)

Symbol	Parameters		Value	Unit
I_{GT}	$V_D = 12$ V, $R_L = 33$ Ω	Max.	200	μ A
V_{GT}		Max.	0.8	V
V_{GD}	$V_D = V_{DRM}$, $R_L = 3.3$ k Ω , $R_{GK} = 1$ k Ω , $T_j = 125$ °C	Min.	0.1	V
V_{RG}	$I_{RG} = 10$ μ A	Min.	8	
I_H	$I_T = 50$ mA, $R_{GK} = 1$ k Ω	Max.	5	mA
I_L	$I_G = 1.2 I_{GT}$, $R_{GK} = 1$ k Ω	Max.	6	mA
dV/dt	$V_D = 67\%$ V_{DRM} , $R_{GK} = 1$ k Ω , $T_j = 125$ °C	Min.	75	V/ μ s

Table 3. Static electrical characteristics

Symbol	Test conditions	T_j		Value	Unit
V_T	$I_{TM} = 1.6$ A, $t_p = 380$ μ s	25 °C	Max.	1.95	V
V_{TO}	Threshold on-state voltage	125 °C	Max.	0.95	V
R_d	Dynamic resistance	125 °C	Max.	600	m Ω
I_{DRM}	$V_D = V_{DRM}$	25 °C	Max.	1	μ A
I_{RRM}	$V_R = V_{RRM}$	125 °C		0.1	mA

Table 4. Thermal resistance

Symbol	Parameters	Max. value	Unit
$R_{th(j-l)}$	Junction to lead (DC)	80	°C/W
$R_{th(j-a)}$	Junction to ambient (DC)	150	

1.1 Characteristics (curves)

Figure 1. Maximum power dissipation versus on-state RMS current (full cycle)

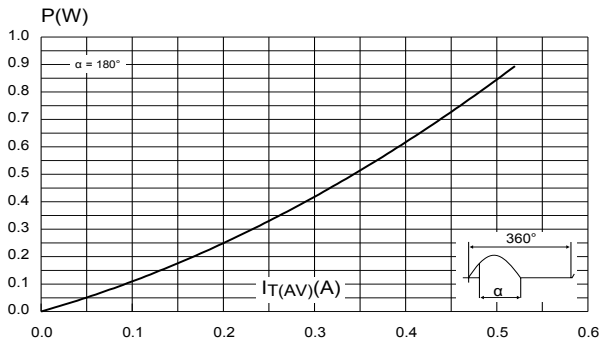

Figure 2. Average and DC on-state current versus lead temperature

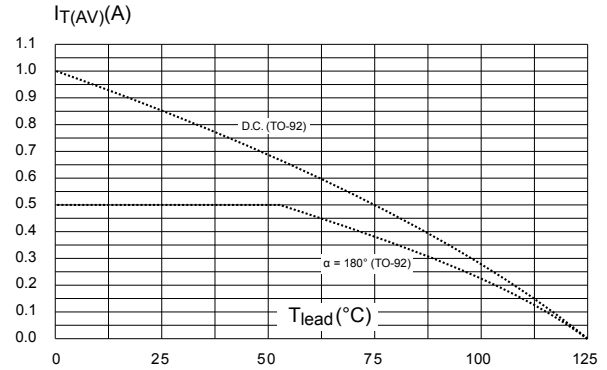

Figure 3. Average and DC on-state current versus ambient temperature

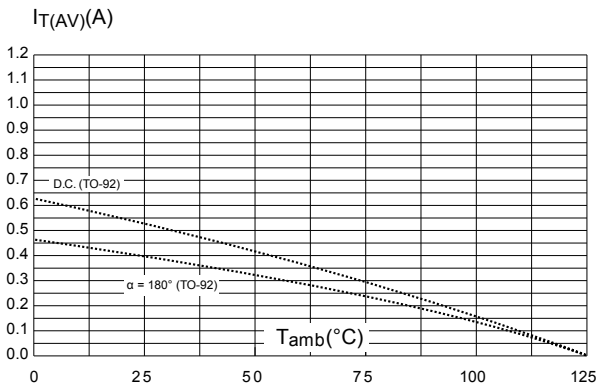

Figure 4. Relative variation of thermal impedance versus pulse duration

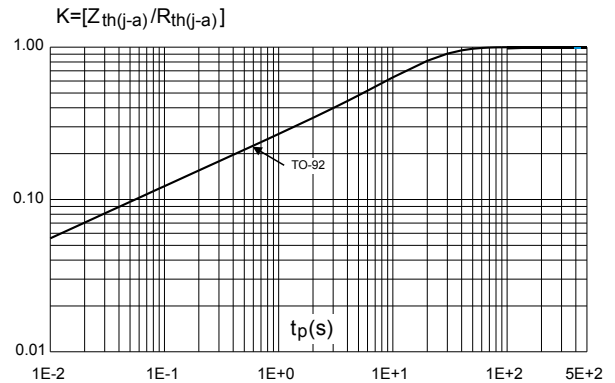

Figure 5. Relative variation of holding current versus gate-cathode resistance

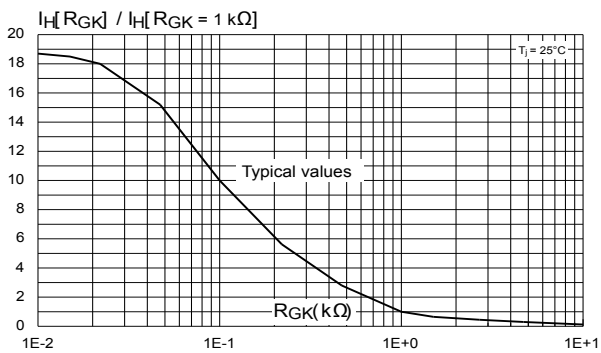

Figure 6. Relative variation of gate voltage and gate, holding and latching current versus junction temperature

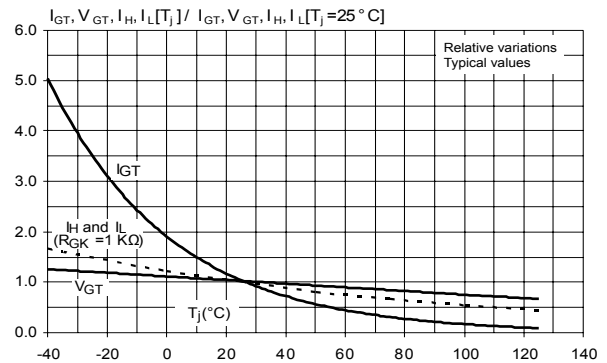

Figure 7. Relative variation of static dV/dt immunity versus gate-cathode resistance

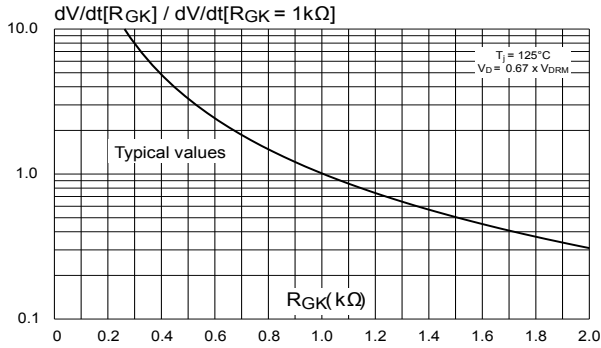

Figure 8. Relative variation of dV/dt immunity versus gate-cathode capacitance

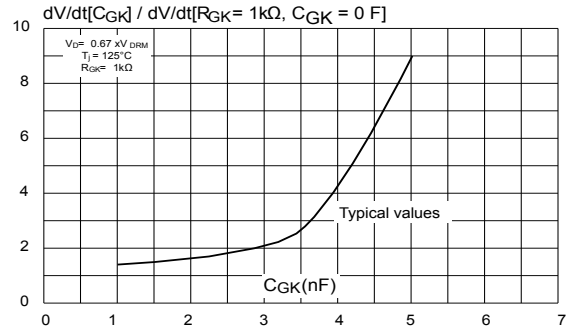

Figure 9. Surge peak on-state current versus number of cycles

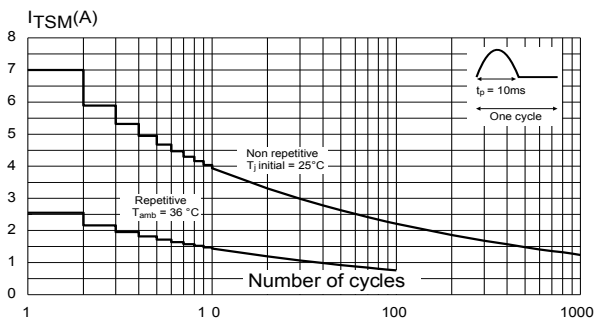

Figure 10. Non-repetitive surge peak on-state current for sinusoidal pulse ($t_p < 10$ ms)

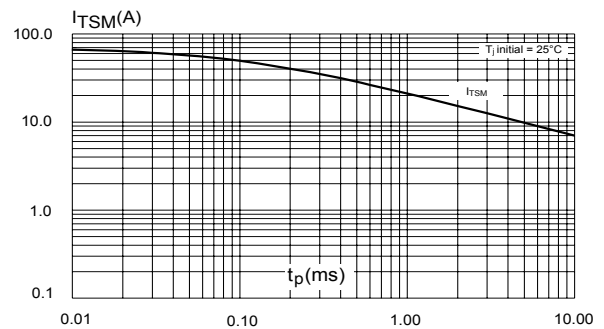
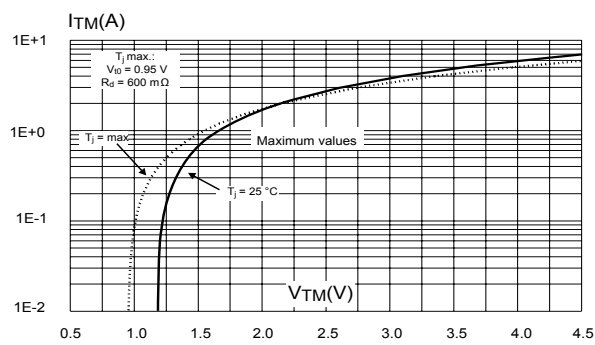

Figure 11. On-state characteristics (maximum values)



2 Package information

In order to meet environmental requirements, ST offers these devices in different grades of **ECOPACK** packages, depending on their level of environmental compliance. ECOPACK specifications, grade definitions and product status are available at: www.st.com. ECOPACK is an ST trademark.

2.1 TO-92 with leads preform (plastic) package information

- Lead free plating + halogen-free molding resin
- Epoxy meets UL94, V0

Figure 12. TO-92 with leads preform (plastic) package outline

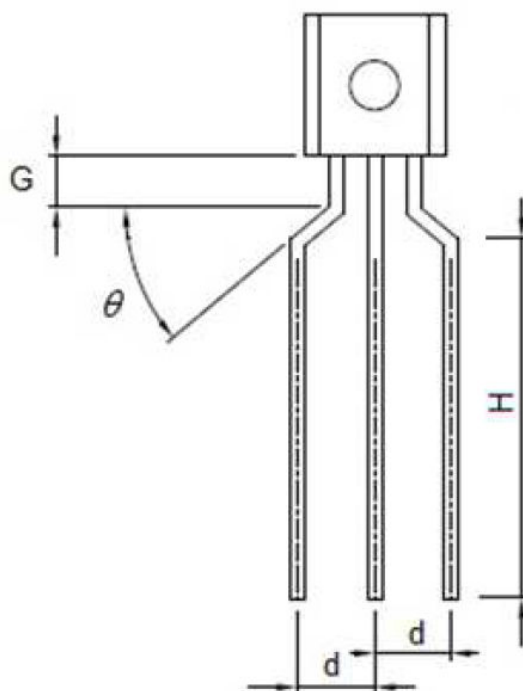

Table 5. TO-92 with leads preform (plastic) package mechanical data

Ref.	Dimensions					
	Millimeters			Inches ⁽¹⁾		
	Min.	Typ.	Max.	Min.	Typ.	Max.
G	1.30	1.70	2.00	0.051	0.067	0.079
H	7.69		9.69	0.303		0.381
d	2.40		2.90	0.094		0.114
θ	30°	40°	50°	30°	40°	50°

1. Inches dimensions given for information

2.2 TO-92 with straight leads (plastic) package information

- Lead free plating + halogen-free molding resin
- Epoxy meets UL94, V0

Figure 13. TO-92 with straight leads (plastic) package outline

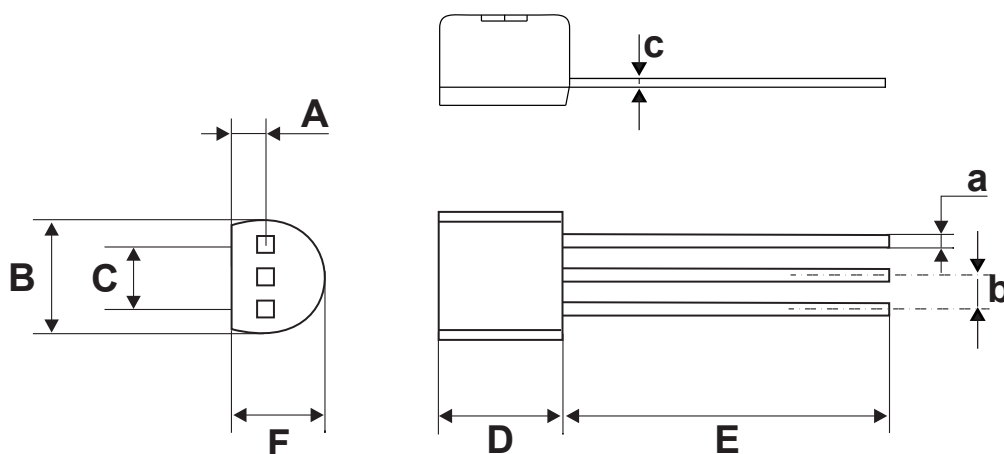

Table 6. TO-92 with straight leads (plastic) package mechanical data

Ref.	Dimensions					
	Millimeters			Inches ⁽¹⁾		
	Min.	Typ.	Max.	Min.	Typ.	Max.
A		1.35			0.048	
B			4.70			0.190
C		2.54			0.100	
D	4.40			0.172		
E	12.70			0.554		
F			3.70			0.152
a			0.50			0.022
b		1.27			0.050	
c			0.48			0.019

1. Inches dimensions given for information

3 Ordering information

Figure 14. Ordering information scheme

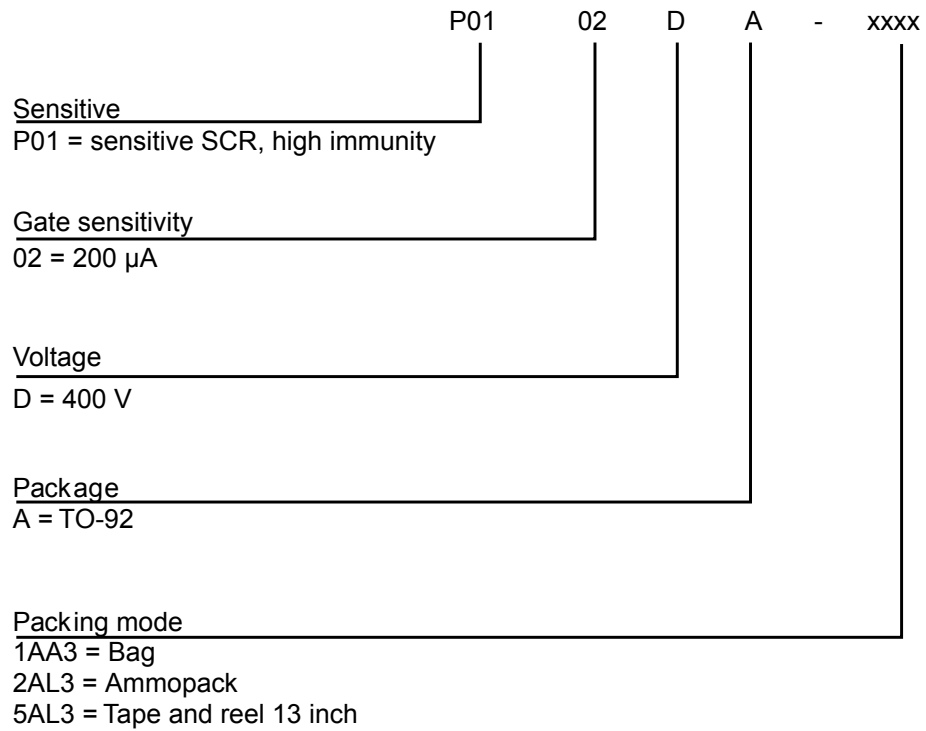

Table 7. Ordering information

Order code	Marking	Package	Weight	Base qty.	Delivery mode
P0102DA 1AA3	P0102 DA	TO-92 Straight Leads	0.22 g	2500	Bag
P0102DA 2AL3		TO-92 Preformed Leads		2000	AMMOPACK not in dry bag
P0102DA 5AL3		TO-92 Preformed Leads		2000	Tape and reel 13"

Revision history

Table 8. Document revision history

Date	Revision	Changes
14-Oct-2019	1	Initial release.
18-May-2020	2	Updated <i>Cover image</i> .
03-Apr-2024	3	Updated Section 2: Package information , and Table 7 .

IMPORTANT NOTICE – READ CAREFULLY

STMicroelectronics NV and its subsidiaries (“ST”) reserve the right to make changes, corrections, enhancements, modifications, and improvements to ST products and/or to this document at any time without notice. Purchasers should obtain the latest relevant information on ST products before placing orders. ST products are sold pursuant to ST’s terms and conditions of sale in place at the time of order acknowledgment.

Purchasers are solely responsible for the choice, selection, and use of ST products and ST assumes no liability for application assistance or the design of purchasers’ products.

No license, express or implied, to any intellectual property right is granted by ST herein.

Resale of ST products with provisions different from the information set forth herein shall void any warranty granted by ST for such product.

ST and the ST logo are trademarks of ST. For additional information about ST trademarks, refer to www.st.com/trademarks. All other product or service names are the property of their respective owners.

Information in this document supersedes and replaces information previously supplied in any prior versions of this document.

© 2024 STMicroelectronics – All rights reserved