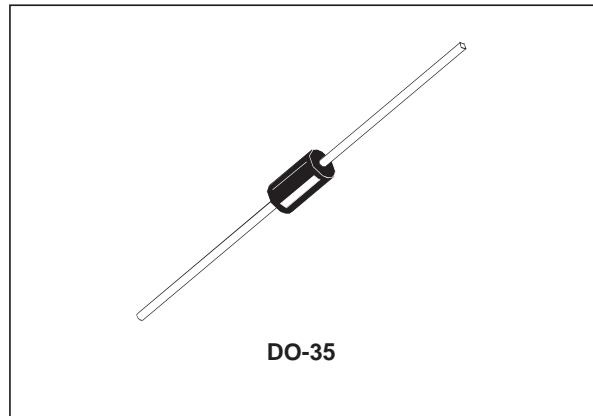

**SMALL SIGNAL SCHOTTKY DIODE**
**DESCRIPTION**

General purpose, metal to silicon diode featuring high breakdown voltage low turn-on voltage.

**ABSOLUTE RATINGS** (limiting values)

Symbol	Parameter		Value	Unit
$V_{RRM}$	Repetitive Peak Reverse Voltage		100	V
$I_F$	Forward Continuous Current*	$T_a = 25^\circ\text{C}$	150	mA
$I_{FRM}$	Repetitive Peak Forward Current*	$t_p \leq 1\text{s}$ $\delta \leq 0.5$	350	mA
$I_{FSM}$	Surge non Repetitive Forward Current*	$t_p = 10\text{ms}$	750	mA
$P_{tot}$	Power Dissipation*	$T_l = 80^\circ\text{C}$	150	mW
$T_{stg}$ $T_j$	Storage and Junction Temperature Range		- 65 to + 150 - 65 to + 125	$^\circ\text{C}$
$T_L$	Maximum Temperature for Soldering during 10s at 4mm from Case		230	$^\circ\text{C}$

**THERMAL RESISTANCE**

Symbol	Test Conditions	Value	Unit
$R_{th(j-a)}$	Junction-ambient*	300	$^\circ\text{C/W}$

\* On infinite heatsink with 4mm lead length.

**ELECTRICAL CHARACTERISTICS**

**STATIC CHARACTERISTICS**

Symbol	Test Conditions		Min.	Typ.	Max.	Unit
$V_{BR}$	$T_j = 25^\circ\text{C}$	$I_R = 100\mu\text{A}$	100			V
$V_F^*$	$T_j = 25^\circ\text{C}$	$I_F = 0.1\text{mA}$			0.25	V
	$T_j = 25^\circ\text{C}$	$I_F = 10\text{mA}$			0.45	
	$T_j = 25^\circ\text{C}$	$I_F = 250\text{mA}$			1	
$I_R^*$	$T_j = 25^\circ\text{C}$	$V_R = 1.5\text{V}$			0.5	$\mu\text{A}$
	$T_j = 60^\circ\text{C}$				5	
	$T_j = 25^\circ\text{C}$	$V_R = 10\text{V}$			0.8	
	$T_j = 60^\circ\text{C}$				7.5	
	$T_j = 25^\circ\text{C}$	$V_R = 50\text{V}$			2	
	$T_j = 60^\circ\text{C}$				15	
	$T_j = 25^\circ\text{C}$	$V_R = 75\text{V}$			5	
	$T_j = 60^\circ\text{C}$				20	

**DYNAMIC CHARACTERISTICS**

Symbol	Test Conditions		Min.	Typ.	Max.	Unit
C	$T_j = 25^\circ\text{C}$	$V_R = 0\text{V}$		10		$\text{pF}$
	$T_j = 25^\circ\text{C}$	$V_R = 1\text{V}$		6		

\* Pulse test:  $t_p \leq 300\mu\text{s}$   $\delta < 2\%$ .

**Fig. 1-1:** Forward voltage drop versus forward current (low level, typical values)

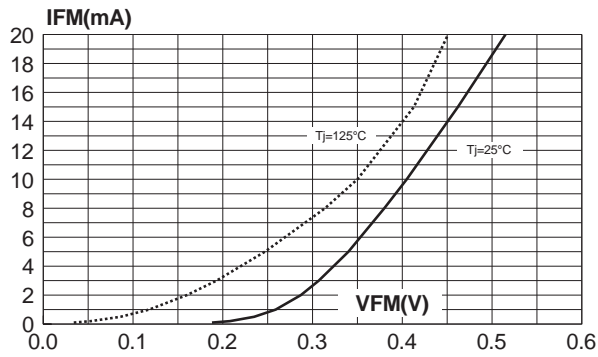

**Fig. 1-2:** Forward voltage drop versus forward current (high level, typical values)

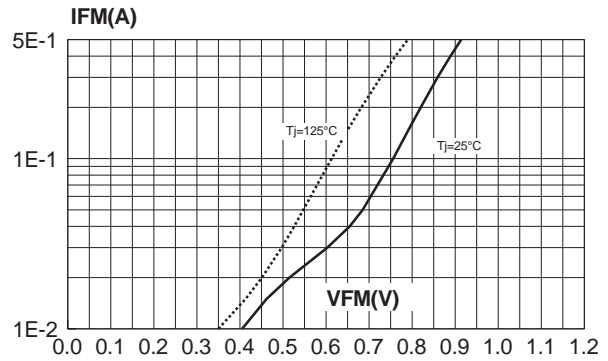

**Fig. 2:** Leakage current versus reverse voltage applied (typical values)

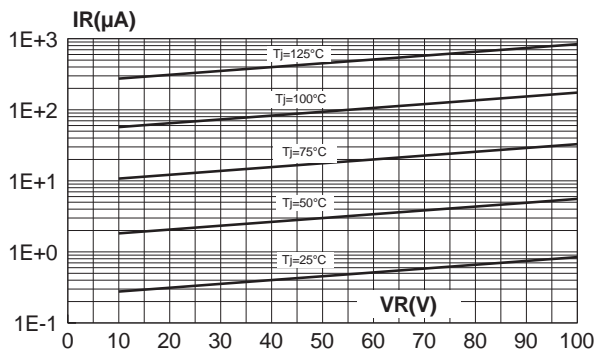

**Fig. 3:** Leakage current versus junction temperature (typical values)

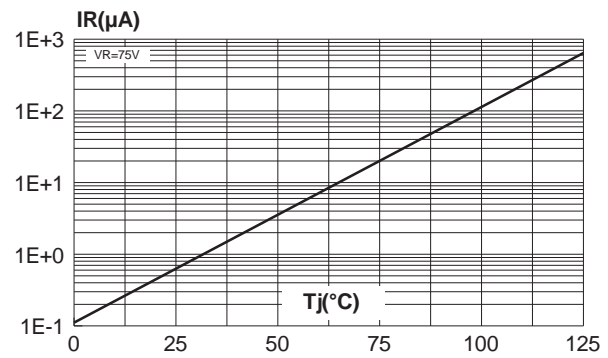

**Fig. 4:** Junction capacitance versus reverse voltage applied (typical values)

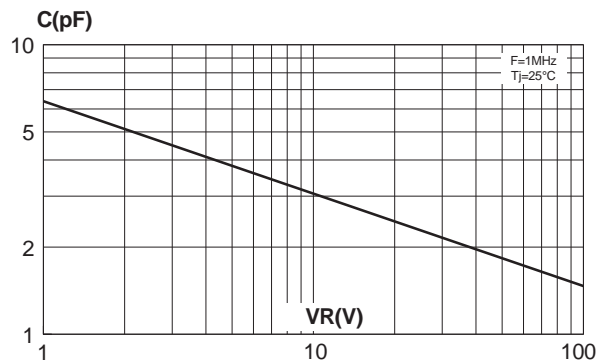

**PACKAGE MECHANICAL DATA**  
DO-35

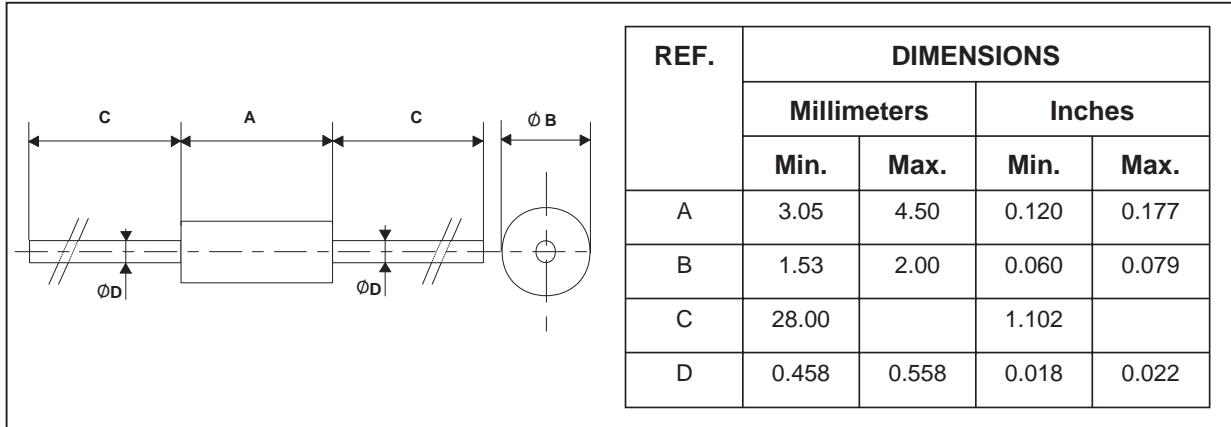

- Cooling method: by convection and conduction
- Marking: clear, ring at cathode end
- Weight: 0.15g

Information furnished is believed to be accurate and reliable. However, STMicroelectronics assumes no responsibility for the consequences of use of such information nor for any infringement of patents or other rights of third parties which may result from its use. No license is granted by implication or otherwise under any patent or patent rights of STMicroelectronics. Specifications mentioned in this publication are subject to change without notice. This publication supersedes and replaces all information previously supplied. STMicroelectronics products are not authorized for use as critical components in life support devices or systems without express written approval of STMicroelectronics.

The ST logo is a registered trademark of STMicroelectronics

© 2001 STMicroelectronics - Printed in Italy - All rights reserved.

STMicroelectronics GROUP OF COMPANIES

Australia - Brazil - China - Finland - France - Germany - Hong Kong - India - Italy - Japan - Malaysia  
Malta - Morocco - Singapore - Spain - Sweden - Switzerland - United Kingdom - U.S.A.

<http://www.st.com>