

USB 2.0 high-speed Flash drive controller

Not For New Design

Features

- USB 2.0 interface compatible with mass storage device class
 - Integrated USB 2.0 PHY supporting USB high speed and full speed
 - Suspend and Resume operations
 - Mass storage controller interface (MSCI)
 - Supports 2 KB-page NAND Flash devices including Numonyx, Hynix, Samsung, Toshiba, Micron, Renesas
 - Reed-Solomon encoder/decoder on-the-fly correction (4 bytes of a 512-byte block)
 - Flash identification support
 - Up to 12 MB/s for read and 8 MB/s for write operations in single channel
 - Up to 4 NAND Flash supported per channel
 - Embedded ST7 8-bit MCU
 - Supply management
 - 3.3 V operation
 - Integrated 3.3-1.8 V voltage regulator
 - USB 2.0 low-power device compliant
 - Less than 100 mA during write operation with two NAND Flash devices
 - Less than 500 μ A in suspend mode
 - AutoRun CDRom partition support
 - Bootability support (HDD mode)
- 

LQFP48 7x7

 - Clock management
 - Integrated PLL for generating core+USB 2.0 clocks from external 12 MHz crystal
 - Data protection
 - Write protect switch control
 - Public/private partitions support
 - Production tool device configurability:
 - USB vendor ID/product ID (VID/PID), serial number and USB strings with foreign language support
 - SCSI strings
 - One or two LED outputs
 - Adjustable NAND Flash bus frequency to reach highest performance
 - Code update in the NAND Flash memory
 - LQFP48 7x7 ECOPACK[®] package
 - Development support
 - Complete reference design including schematics, BOM and Gerber files
 - Supports Windows (Vista, XP, 2000, ME), Linux and MacOS. Drivers available for Windows 98 SE

Table 1. Device summary

Features	Orderable part numbers	
	ST72681/R20	ST72681/R21
USB interface	USB 2.0 high speed	
Number of NAND Flash devices supported ⁽¹⁾	up to 1	up to 4
R/W speed	11MB/s and 7MB/s	12MB/s and 8MB/s
Operating voltage	3.0 to 3.6 V	
Operating temperature	0 to +70 °C	
Package	LQFP48 7x7 / Die form	

1. Number of NAND Flash devices supported in a single channel.

Contents

1	Introduction	4
2	Pin description	5
3	Application schematics	8
4	NAND Flash interface	10
4.1	NAND Flash support table	10
4.2	NAND error correction	11
4.2.1	Hardware error correction	11
4.2.2	Firmware error management	11
4.3	Management of bad NAND Flash blocks	11
4.3.1	Bad block identification	11
4.3.2	Bad block replacement	12
4.3.3	Late fail block	12
4.4	Wear levelling	12
4.4.1	LUT usage	12
4.5	NAND Flash interface configuration	13
5	Mass storage implementation	14
5.1	USB characteristics	14
5.2	BOT / SCSI implementation	14
5.2.1	BOT specification	14
5.2.2	SCSI specification	14
5.2.3	Bootability specification	14
5.3	Multi-LUN device characteristics	14
5.3.1	Public drive	15
5.3.2	Private drive	15
5.3.3	Additional drive	15
5.3.4	CD-ROM considerations	15
5.4	Mass storage interface configuration	15
6	Human interface implementation	16
6.1	LED behavior	16
6.2	Read only switch	16
7	Electrical characteristics	17

7.1	Parameter conditions	17
7.1.1	Minimum and maximum values	17
7.1.2	Typical values	17
7.1.3	Typical curves	17
7.1.4	Loading capacitor	17
7.1.5	Pin input voltage	18
7.2	Absolute maximum ratings	18
7.2.1	Voltage characteristics	18
7.2.2	Current characteristics	19
7.2.3	Thermal characteristics	19
7.3	Operating conditions	19
7.3.1	General operating conditions	19
7.4	Supply current characteristics	20
7.4.1	RUN and SUSPEND modes	20
7.4.2	Supply and clock managers	20
7.5	Clock and timing characteristics	20
7.5.1	General timings	20
7.5.2	Crystal oscillator	21
7.6	EMC characteristics	22
7.6.1	Functional EMS (electromagnetic susceptibility)	22
7.6.2	Electromagnetic interference (EMI)	23
7.6.3	Absolute maximum ratings (electrical sensitivity)	23
7.7	I/O port pin characteristics	24
7.7.1	General characteristics	24
7.7.2	Output driving current	25
7.8	Control pin characteristics	27
7.8.1	Asynchronous RESET pin	27
7.9	Other communication interface characteristics	28
7.9.1	MSCI parallel interface	28
7.9.2	Universal serial bus interface (USB)	29
8	Package mechanical data	31
9	Device ordering information	32
10	Revision history	33

1 Introduction

The ST72681 is a USB 2.0 high-speed Flash drive controller. The USB 2.0 high-speed interface including PHY and function supports USB 2.0 mass storage device class.

The mass storage controller interface (MSCI) combined with the Reed-Solomon encoder/decoder on-the-fly correction (4-byte on 512-byte data blocks) provides a flexible, high transfer rate solution for interfacing a wide of range NAND Flash memory device types.

The internal 60 MHz PLL driven by the 12 MHz oscillator is used to generate the 480 MHz frequency for the USB 2.0 PHY.

The ST7 8-bit CPU runs the application program from the internal ROM and RAM. USB data and patch code are stored in internal RAM.

I/O ports provide functions for EEPROM connection, LEDs and write protect switch control.

The internal 3.3 V to 1.8 V voltage regulator provides the 1.8 V supply voltage to the digital part of the circuit.

Figure 1. Device block diagram

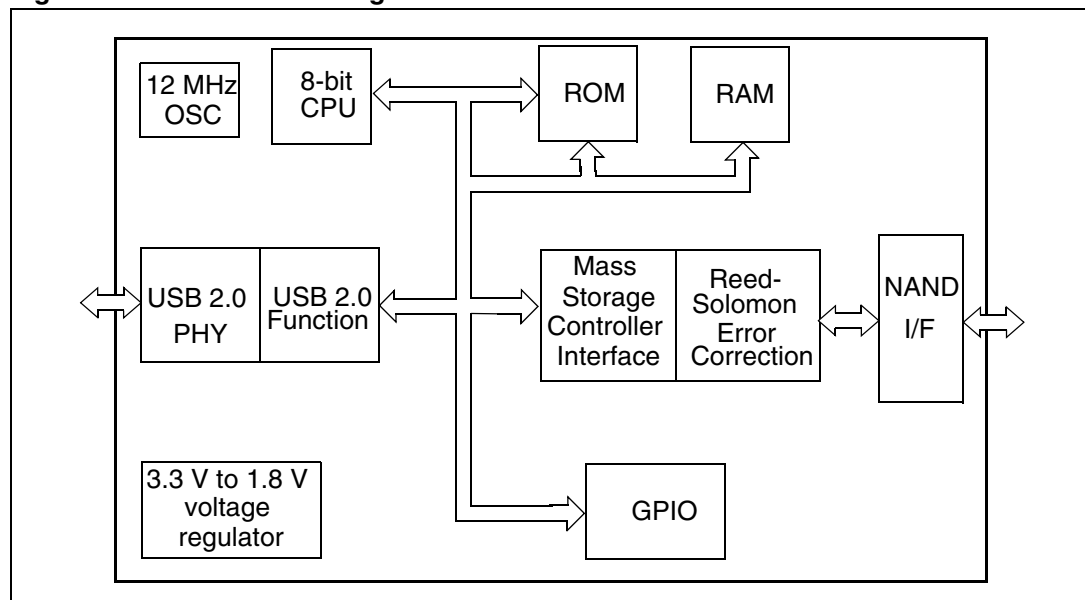

2 Pin description

Figure 2 shows the LQFP48 package pinout, while Table 2, Table 3, Table 4, and Table 5 give the pin description.

The legend and abbreviations used in these tables are the following:

- Type
 - I = input
 - O = output
 - S = supply
- Input level: A = Dedicated analog input
- In/Output level
 - C_T = CMOS 0.3V_{DD}/0.7V_{DD} with input trigger
 - T_T = TTL 0.8V / 2 V with Schmitt trigger
- Output level
 - D8 = 8mA drive
 - D4 = 4mA drive
 - D2 = 2mA drive

Figure 2. 48-pin LQFP package pinout

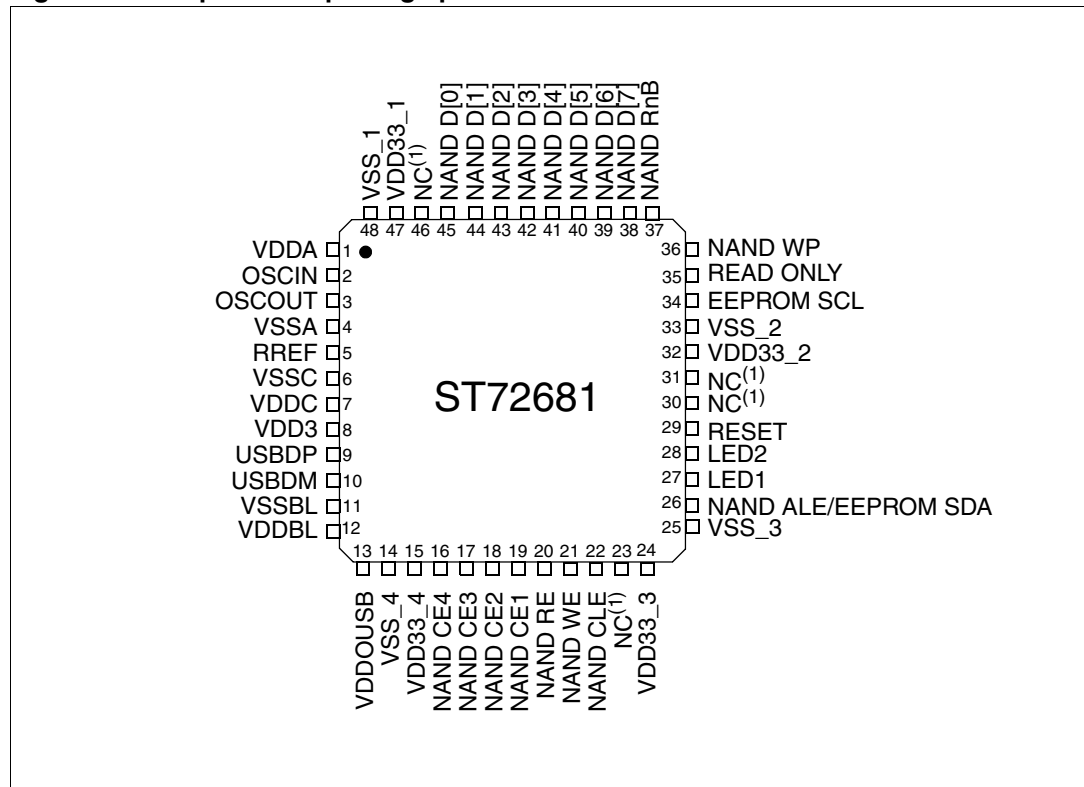

1. Must remain NOT connected in the application.

Table 2. Power supply

Pin	Pin name	Type	Description
48	VSS_1	S	Ground
47	VDD33_1	S	I/Os and regulator supply voltage
33	VSS_2	S	Ground
32	VDD33_2	S	I/Os and regulator supply voltage
25	VSS_3	S	Ground
24	VDD33_3	S	I/Os and regulator supply voltage
14	VSS_4	S	Ground
15	VDD33_4	S	I/Os and regulator supply voltage
13	VDDOUSB	S	USB2 PHY, OSC and PLL power supply output (1.8 V)

Table 3. USB 2.0 interface

Pin	Pin name	Type	Description
12	VDDBL	S	Supply voltage for buffers and de-serialization flip flops (1.8 V)
11	VSSBL	S	Ground for buffers and de-serialization flip flops (1.8 V)
10	USBDM	I/O	USB2 DATA -
9	USBDP	I/O	USB2 DATA +
8	VDD3	S	Supply voltage for the FS compliance (3.3 V)
7	VDDC	S	Supply voltage for DLL & XOR tree (1.8 V)
6	VSSC	S	Ground for DLL & XOR tree (1.8 V)
5	RREF	I/O	Ref. resistor for integrated impedance process adaptation (11.3 kOhms 1% pull down)

Table 4. USB 2.0 and core clock system

Pin	Pin name	Type	Description
4	VSSA	S	Ground for oscillator & PLL (1.8 V)
3	OSCOUT	O	12 MHz oscillator output
2	OSCIN	I	12 MHz oscillator input
1	VDDA	S	Supply voltage for oscillator & PLL (1.8 V)

Table 5. General purpose I/O ports /mass storage I/Os

Pin	Pin name	Type	Level		Main function (after reset)
			Input	Outputs	
45	NAND D[0]	I/O	T _T	D4	NAND Data [0]
44	NAND D[1]	I/O	T _T	D4	NAND Data [1]
43	NAND D[2]	I/O	T _T	D4	NAND Data [2]
42	NAND D[3]	I/O	T _T	D4	NAND Data [3]
41	NAND D[4]	I/O	T _T	D4	NAND Data [4]
40	NAND D[5]	I/O	T _T	D4	NAND Data [5]
39	NAND D[6]	I/O	T _T	D4	NAND Data [6]
38	NAND D[7]	I/O	T _T	D4	NAND Data [7]
26	NAND ALE	I/O	T _T	D8	NAND Address Latch Enable
22	NAND CLE	O	T _T	D8	NAND Command Latch Enable
21	NAND WE	O	T _T	D8	NAND WRite Enable
20	NAND RE	O	T _T	D8	NAND read enable
19	NAND CE1	O	T _T	D4	NAND Chip Enable 1
18	NAND CE2	O	T _T	D4	NAND Chip Enable 2
17	NAND CE3	O	T _T	D4	NAND Chip Enable 3
16	NAND CE4	O	T _T	D4	NAND Chip Enable 4
37	NAND RnB	I	T _T	D2	NAND Ready/ $\overline{\text{Busy}}$
36	NAND WP	O	T _T	D2	NAND Write Protect
35	READ ONLY	I	T _T	D2	Read -only switch ("0": Read/Write; "1": Read only)
34	EEPROM SCL	O	T _T	D2	EEPROM serial clock
28	LED2	O	T _T	D8	Green LED (USB access)
27	LED1	O	T _T	D8	Red LED (NAND memory access)

3 Application schematics

Figure 3. Application schematic

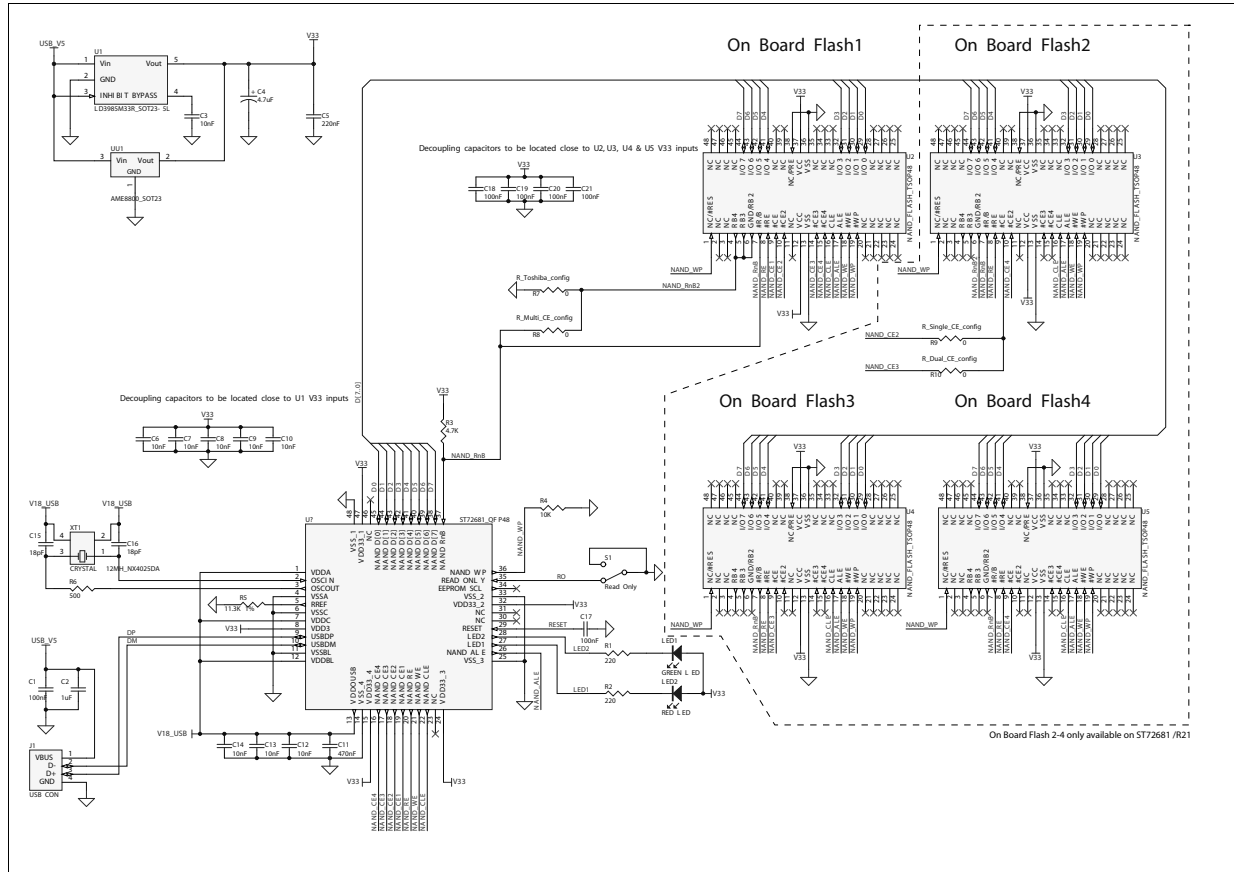

ST72681/R20 only supports single NAND Flash Chip Enable configuration (one NAND Flash device with one Chip Enable signal). Note that pins NAND_RnB2, NAND_CE2, NAND_CE3 and NAND_CE4 should remain unconnected.

ST72681/R21 can support up to four NAND Flash Chip Enable signals. The application can use one of the following configurations:

- One NAND Flash device with four Chip Enable signals; NAND_CE1, NAND_CE2, NAND_CE3 and NAND_CE4 are used.
- One NAND Flash device with two Chip Enable signals; NAND_CE1 and NAND_CE2 are used.
- One NAND Flash device with one Chip Enable signal; only NAND_CE1 is used.
- Two NAND Flash devices with two Chip Enable signals; NAND_CE1 and NAND_CE2 are used to select the first NAND Flash device and NAND_CE3 and NAND_CE4 to select the second NAND Flash device.
- Two NAND Flash devices with one Chip Enable signal; NAND_CE1 and NAND_CE2 are used to select is used to select the first NAND Flash device and the 2nd NAND Flash device, respectively.
- 4 NAND Flash devices with 1Chip Enable signal; NAND_CE1 selects the first NAND Flash device, NAND_CE2 the 2nd NAND Flash device, NAND_CE3 to select the third, and NAND_CE4 to select the fourth NAND Flash device.

4 NAND Flash interface

4.1 NAND Flash support table

Table 6. Known NAND Flash compatibility guide for R20 and R21 devices⁽¹⁾⁽²⁾

NAND name	NAND size (Mbytes or Gbytes) and type	Number of NAND devices supported	
		R20 device	R21 device
Samsung K9F1G08U	128 MB; SLC2K; Single CE	1	1, 2, 3 or 4
Samsung K9F2G08U	256 MB; SLC2K; Single CE	1	1, 2, 3 or 4
Samsung K9F4G08U	512 MB; SLC2K; Single CE	1	1, 2, 3 or 4
Samsung K9K4G08U	512 MB; SLC2K; Single CE	1	1, 2, 3 or 4
Samsung K9W4G08U	512 MB; SLC2K; Dual CE	-	1 or 2
Samsung K9K8G08U	1 GB; SLC2K; Single CE	1	1, 2, 3 or 4
Samsung K9W8G08U	1 GB; SLC2K; Dual CE	-	1 or 2
Samsung K9WAG08U	2 GB; SLC2K; Dual CE	-	1 or 2
Samsung K9NBG08U	4 GB; SLC2K; Quad CE	-	1
Samsung K9G4G08U	512 MB; MLC2K; Single CE	1	1, 2, 3 or 4
Samsung K9L8G08U	1 GB; MLC2K; Single CE	1	1, 2, 3 or 4
Samsung K9HAG08U	2 GB; MLC2K; Dual CE	-	1 or 2
Samsung K9MBG08U	4 GB; MLC2K; Quad CE	-	1
Toshiba TH58NVG0S3	128 MB; SLC2K; Single CE	1	1, 2, 3 or 4
Toshiba TH58NVG1S3	256 MB; SLC2K; Single CE	1	1, 2, 3 or 4
Toshiba TH58NVG2S3	512 MB; SLC2K; Single CE	1	1, 2, 3 or 4
Toshiba TH58NVG1D4	256 MB; MLC2K; Single CE	1	1, 2, 3 or 4
Toshiba TH58NVG2D4	512 MB; MLC2K; Single CE	1	1, 2, 3 or 4
Toshiba TH58NVG3D4	1 GB; MLC2K; Single CE	1	1, 2, 3 or 4
Numonyx NAND01GW3B	128 MB; SLC2K; Single CE	1	1, 2, 3 or 4
Numonyx NAND02GW3B	256 MB; SLC2K; Single CE	1	1, 2, 3 or 4
Numonyx NAND04GW3B	512 MB; SLC2K; Single CE	1	1, 2, 3 or 4
Numonyx NAND08GW3B	1 GB; SLC2K; Single CE	1	1, 2, 3 or 4
Numonyx NAND04GW3C	512 MB; MLC2K; Single CE	1	1, 2, 3 or 4
Hynix HY27UF081G2M	128 MB; SLC2K; Single CE	1	1, 2, 3 or 4
Hynix HY27UG082G2M	256 MB; SLC2K; Single CE	1	1, 2, 3 or 4
Hynix HY27UG084G2M	512 MB; SLC2K; Single CE	1	1, 2, 3 or 4
Hynix HY27UH084G5M	512 MB; SLC2K; Dual CE	-	1 or 2
Hynix HY27UH088G2M	1 GB; SLC2K; Single CE	1	1, 2, 3 or 4
Hynix HY27UT084G2M	512 MB; MLC2K; Single CE	1	1, 2, 3 or 4
Hynix HY27UU088G5M	1 GB; MLC2K; Dual CE	-	1 or 2
Micron 29F2G08AA	256 MB; SLC2K; Single CE	1	1, 2, 3 or 4
Micron 29F4G08BA	512 MB; SLC2K; Single CE	1	1, 2, 3 or 4
Micron 29F8G08FA	1 GB; SLC2K; Dual CE	-	1 or 2

1. This list is provided as a guide only as it is not possible to automatically guarantee support for all the additions and updates across the listed ranges of manufacturers' devices.
2. Only NAND Flash devices with 2 Kbyte pages are supported.

4.2 NAND error correction

No NAND Flash memory arrays are guaranteed by manufacturers to be error-free. Error occurrence depends on the Flash cell type (MLC or SLC).

The ST72681 embeds hardware and firmware mechanisms to correct the errors.

4.2.1 Hardware error correction

The ST72681 embeds a Reed-Solomon algorithm-based hardware cell. This cell directly manages 512-byte data packets on the NAND Flash I/O system.

Based on a data packet contents, the cell generates an 80-bit Error Correction Code (ECC) consisting of 8 words each containing 10 bits.

During write operations to NAND memory, the 512-bytes of data and the ECC are stored together in the same page. The ECC is stored in the corresponding Redundant Area (RA), using 10 bytes.

During read operations, the 512-bytes of data and the 8 ECC words are read back and are passed through the Reed-Solomon cell for decoding. The cell allows the correction of 4 symbols in this 520-symbol packet (512 symbols from data + 8 symbols from ECC).

The hardware cell gives 3 possible results:

- No error detected: the data packet can be used as it is.
- Correctable error detected: the corrected data are available in a specific 512-byte buffer in the Reed-Solomon cell and are ready to use.
- Uncorrectable error detected: data corruption is not repairable.

4.2.2 Firmware error management

The firmware defines the error correction possibilities with the corrected data packet.

When data is not repairable, the block is considered as bad and replaced by another one. See below for further information.

4.3 Management of bad NAND Flash blocks

NAND Flash device manufacturers deliver their products with factory-marked bad blocks. This marking depends on the manufacturer and the NAND Flash type (page size, memory technology, etc.). The ST72681 supports all bad block markings currently available on the market.

4.3.1 Bad block identification

During firmware initialization, the MCU scans the entire NAND Flash configuration to identify bad blocks.

A bad block is defined as follows:

- 5 different Block Status bytes are considered: 4 Status bytes from page 0 and 1 from an other page (page 127 for MLC NAND Flash memory; page 1 for SLC NAND Flash memory).
- The considered block is declared bad if 1 of these 5 bytes contains 4 bits or more at 0.

4.3.2 Bad block replacement

The firmware works with groups of 1024 blocks, called zones. A complete NAND Flash configuration can contain several zones.

Each zone is described in a Look Up Table (LUT) containing 1024 entries. A LUT is composed of 3 parts: used blocks, free blocks and bad blocks.

- The “bad blocks” part contains as many entries as the number of bad blocks identified in that zone.
- The “used blocks” part can have a size of 1000, 900 or 500 entries. This size is configurable and also depends on the number of identified bad blocks.
- The “free blocks” part contains the remaining entries.

The used blocks part is used to do a correspondence between NAND Flash blocks and logical address ranges.

This system allows all bad blocks to be masked from the Host. As a result, bad blocks are never seen. Only a range of logical addresses are visible which correspond to the sum of the used blocks part of all zones.

4.3.3 Late fail block

During normal application life, defects can appear in the NAND Flash memory. Under certain conditions, these defects are not correctable and the corresponding block is declared as “bad”.

In this case, new bad blocks are identified in the bad blocks part of the LUT and replaced by new blocks from the “free blocks” part.

4.4 Wear levelling

During normal application life, the NAND Flash memories written and erased (by block) many times. The NAND Flash device is guaranteed for a limited number of writes (about 100 000 cycles). As a consequence, the controller must keep write/erase operations to a minimum for any individual block.

A method to limit these cycles is to use a “Wear Levelling” scheme between all NAND Flash memory blocks.

4.4.1 LUT usage

The LUT is used for transfers between a logical address range and a block. It contains free blocks which are used in the “wear levelling” scheme.

During write command treatment, the firmware calculates the zones, blocks and pages for data write access. In a block write operation, the firmware applies the following scheme to avoid block wearing:

- The least recently-used block is chosen from the free block part of the LUT.
- Valid data from the old block is copied to the new block.
- New data from the write command is written to the new block.
- The old block is erased.
- The LUT is updated after identifying the new block in the used block part and the old block in the free block part.

Using this scheme, a logical address range doesn't correspond to a constant block. A write command repeated several times to the same logical address writes physically into different blocks.

This method shares the wearing evenly across all blocks of the concerned zone.

4.5 NAND Flash interface configuration

Applications based on ST72681 can be configured through a dedicated PC software tool.

The NAND Flash RE and WE signals frequencies can be independently configured to 30 MHz, 20 MHz, 15 MHz, 12 MHz and 10 MHz.

The logical size reduction factor can be configured to 90% or 50% in the event of having too many bad blocks. this option resizes the used blocks part of the LUT to 900 or 500.

5 Mass storage implementation

5.1 USB characteristics

The ST72681 is compliant with USB 2.0 specification.

It is able to operate in both high speed and full speed modes using a bidirectional control endpoint 0 and a bidirectional bulk endpoint 2.

It automatically recognizes the speed to use on the bus by a process of negotiation with USB Host.

5.2 BOT / SCSI implementation

5.2.1 BOT specification

The USB Mass Storage Class Bulk Only Transport (BOT) specification version 1.0 is implemented. It allows the device to be recognized by the host as a mass-storage USB device.

5.2.2 SCSI specification

Moreover, inside BOT transfers, SCSI commands are encapsulated for mass storage operations.

The related specifications are SBC-2 revision 10 (SCSI Block Commands 2) and SPC-4 revision 7a (SCSI Primary Commands 4).

5.2.3 Bootability specification

The USB Mass Storage Specification for Bootability revision 1.0 is implemented.

It allows the PC host to boot the operating system from the USB mass storage application. In this case, the Host uses BOT LUN 0 (logical unit number).

A specific tool must be used to format the logical drive in order to make it bootable by programming the correct information.

5.3 Multi-LUN device characteristics

The application can be configured with a dedicated PC software tool as a multi-LUN device.

In this case, up to 3 different drives are available: public drive, additional drive and private drive.

Public and additional drives can be configured as removable drive, hard disk drive or CD-ROM drive.

5.3.1 Public drive

The public drive is the default configuration in a mono-LUN mode. In this default case, it is declared as a removable drive.

The public drive is mandatory and can not be removed from the configuration. By customization (using PC software), it can be declared as a removable drive, a CD-ROM drive or a hard disk drive.

This drive is the LUN 0 in BOT commands.

5.3.2 Private drive

The Private drive is optional. Its type is “removable drive” and is not configurable.

This drive is protected by password and cannot be directly accessed through the PC operating system. A PC software tool is necessary to send a command with the password to unlock the device. The device is then open and accessible by the PC operating system until reset or reception of a new command to lock the drive.

This drive is the LUN 1 in BOT commands.

5.3.3 Additional drive

The additional drive is optional. Its type can be “removable drive”, “hard disk drive” or “CD-ROM drive”.

This drive is LUN 1 in BOT commands if the private drive option is not active, and is LUN 2 if the private drive option is active.

5.3.4 CD-ROM considerations

When a drive is declared as CD-ROM, the ST72681/R21 manages this drive with a logical block size of 2 Kbytes. To be correctly recognized by the host, it is preferable to build a CDFS partition on this CD-ROM. See the ‘ST7268x Production Tool User Manual’ for more information.

Note that the ST72681/R20 doesn’t consider the CD-ROM partition as a specific case. The logical block size is 512 bytes and any file system can be used.

In both cases, the CD-ROM partition allows the use of the AutoRun operating system feature. During device connection, the CD-ROM partition is recognized and the host tries to run the application corresponding to the ‘autorun.inf’ file present into this CD-ROM partition.

5.4 Mass storage interface configuration

In addition to the parameters already described as configurable in the previous chapters, additional customizable information includes:

- USB parameters: VID, PID, all string information
- SCSI parameters: strings for inquiry commands

6 Human interface implementation

6.1 LED behavior

The application is designed to manage 2 LEDs. This behavior is configurable through PC dedicated software: 'ST7268x Production Tool'.

By default, LED 1 responds to NAND Flash memory access activity and LED 2 responds to USB activity.

Use of LED 1 is optional. When this option is not active, LED 2 reacts to both USB and NAND Flash activity.

6.2 Read only switch

The READ ONLY pin of the ST72681 is an input pin to be connected to VDD or GND depending on the behavior of the device.

- When this pin is connected to GND, no limitations are applied on the PC command received.
- When this pin is connected to VDD or unconnected, the firmware filters all accesses to the NAND Flash which modify the NAND Flash state (write, erase, etc.) and returns an error to the PC.

7 Electrical characteristics

7.1 Parameter conditions

Unless otherwise specified, all voltages are referred to V_{SS} .

7.1.1 Minimum and maximum values

Unless otherwise specified the minimum and maximum values are guaranteed in the worst conditions of ambient temperature, supply voltage and frequencies by tests in production on 100% of the Devices with an ambient temperature at $T_A = 25\text{ }^\circ\text{C}$ and $T_A = T_{A\text{max}}$ (given by the selected temperature range).

Data based on characterization results, design simulation and/or technology characteristics are indicated in the table footnotes and are not tested in production. Based on characterization, the minimum and maximum values refer to sample tests and represent the mean value plus or minus three times the standard deviation (mean $\pm 3\Sigma$).

7.1.2 Typical values

Unless otherwise specified, typical data are based on $T_A = 25\text{ }^\circ\text{C}$ and $V_{DD33} = 3.3\text{ V}$. They are given only as design guidelines and are not tested.

7.1.3 Typical curves

Unless otherwise specified, all typical curves are given only as design guidelines and are not tested.

7.1.4 Loading capacitor

The loading conditions used for pin parameter measurement are shown in [Figure 4](#).

Figure 4. Pin loading conditions

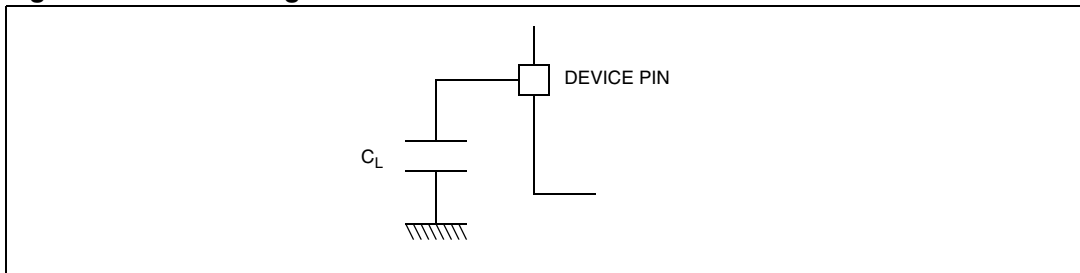

7.1.5 Pin input voltage

The input voltage measurement on a pin of the device is described in [Figure 5](#).

Figure 5. Pin input voltage

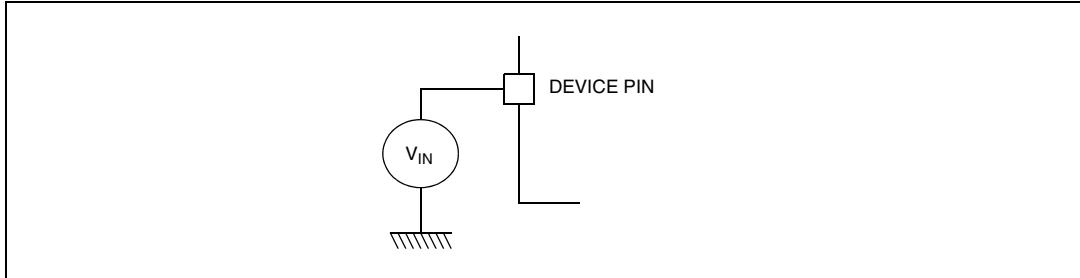

7.2 Absolute maximum ratings

Stresses above those listed as “absolute maximum ratings” may cause permanent damage to the Device. This is a stress rating only and functional operation of the Device under these conditions is not implied. Exposure to maximum rating conditions for extended periods may affect device reliability.

7.2.1 Voltage characteristics

Table 7. Voltage characteristics

Symbol	Ratings	Maximum value	Unit
$V_{DD33} - V_{SS}$	Supply voltage	4.0	V
$V_{IN}^{(1)(2)}$	Input voltage on any other pin	$V_{SS} - 0.3$ to $V_{DD33} + 0.3$	V
$V_{ESD(HBM)}$	Electrostatic discharge voltage (Human Body Model)	See Section 7.6.3 on page 23	
$V_{ESD(MM)}$	Electrostatic discharge voltage (Machine Model)		

1. Directly connecting the \overline{RESET} and I/O pins to V_{DD33} or V_{SS} could damage the device if an unintentional internal reset is generated or an unexpected change of the I/O configuration occurs (for example, due to a corrupted program counter). To guarantee safe operation, this connection has to be done through a pull-up or pull-down resistor (typical: 4.7k Ω for \overline{RESET} , 10k Ω for I/Os). For the same reason, unused I/O pins must not be directly tied to V_{DD33} or V_{SS} .
2. When the current limitation is not possible, the V_{IN} absolute maximum rating must be respected, otherwise refer to $I_{INJ(PIN)}$ specification. A positive injection is induced by $V_{IN} > V_{DD33}$ while a negative injection is induced by $V_{IN} < V_{SS}$.

7.2.2 Current characteristics

Table 8. Current characteristics

Symbol	Ratings	Maximum value	Unit
I_{VDD33}	Total current into V_{DD33} power lines (source) ⁽¹⁾	200	mA
I_{VSS}	Total current out of V_{SS} ground lines (sink) ⁽¹⁾	200	
I_{IO} ⁽²⁾	Output current sunk by any I/O (type D2)	25	
	Output current sunk by any I/O (type D4)	35	
	Output current sunk by any I/O (type D8)	50	
	Output current source by any I/Os and control pin	-25	

1. All power supply (V_{DD33}) and ground (V_{SS}) lines must always be connected to the external supply.
2. Refer to [Table 5: General purpose I/O ports /mass storage I/Os](#) for the output drive capability of each of the I/Os.

7.2.3 Thermal characteristics

Table 9. Thermal characteristics

Symbol	Ratings	Value	Unit
T_{STG}	Storage temperature range	-65 to +150	°C
T_{JMAX}	Maximum junction temperature	120	°C

7.3 Operating conditions

7.3.1 General operating conditions

Table 10. General operating conditions

Symbol	Parameter	Conditions	Min	Max	Unit
f_{CPU}	Internal clock frequency		0	30	MHz
V_{DD33}	Power supply		3.0	3.6	V
T_A	Ambient temperature range		0	70	°C

Figure 6. Guaranteed functionality range

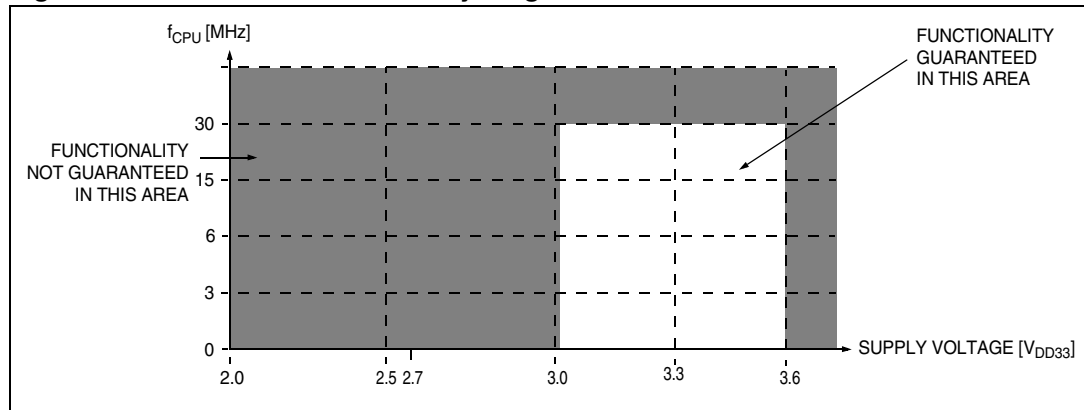

7.4 Supply current characteristics

7.4.1 RUN and SUSPEND modes

Table 11. RUN and SUSPEND modes

Symbol	Parameter	Conditions	Min.	Typ.	Max.	Unit
I _{DD}	Supply current in RUN mode	f _{OSC} = 12 MHz	15	25	35	mA
	Supply current in SUSPEND mode	V _{DD33} = 3.3 V, T _A = +25 °C	60	90	190	µA

7.4.2 Supply and clock managers

Table 12. Supply and clock managers

Symbol	Parameter	Conditions	Typ. ⁽¹⁾	Max. ⁽²⁾	Unit
I _{DD(CK)}	Supply current of crystal oscillator ⁽³⁾		1000	2000	µA

1. Typical data are based on T_A = 25 °C and f_{CPU} = 12 MHz.
2. Not tested in production, guaranteed by characterization.
3. Data based on characterization results done with the external components specified in [Section 7.5.2: Crystal oscillator](#), not tested in production.

7.5 Clock and timing characteristics

Subject to general operating conditions for V_{DD33}, f_{OSC}, and T_A.

7.5.1 General timings

Table 13. General timing characteristics

Symbol	Parameter	Conditions	Min.	Typ. ⁽¹⁾	Max.	Unit
t _{C(INST)}	Instruction cycle time		2	3	12	t _{CPU}
		f _{CPU} = 15 MHz	133	200	800	ns

Table 13. General timing characteristics (continued)

Symbol	Parameter	Conditions	Min.	Typ. ⁽¹⁾	Max.	Unit
$t_{V(IT)}$	Interrupt reaction time ⁽²⁾ $t_{V(IT)} = \Delta t_{c(INST)} + 10$		10		22	t_{CPU}
		$f_{CPU} = 12 \text{ MHz}$	0.666		1.466	μs

1. Data based on typical application software.
2. Time measured between interrupt event and interrupt vector fetch. $\Delta t_{c(INST)}$ is the number of t_{CPU} cycles required to finish executing the current instruction.

7.5.2 Crystal oscillator

The ST72681 internal clock is supplied from a crystal oscillator. All the information given in this paragraph are based on characterization results with specified typical external components. In the application the load capacitors have to be placed as close as possible to the oscillator pins in order to minimize output distortion and start-up stabilization time. Refer to the crystal manufacturer for more details (frequency, package, accuracy...).

Table 14. Crystal oscillator characteristics

Symbol	Parameter	Conditions	Min.	Typ.	Max.	Unit
f_{OSC}	Oscillator frequency			12		MHz
CK_{ACC}	Total crystal oscillator accuracy	abs. value + temp + aging			± 60	ppm
α_{OSC}	Crystal oscillator duty cycle ⁽¹⁾		45	50	55	%

1. The crystal oscillator duty cycle has to be adjusted through the two C_L capacitors. Refer to the crystal manufacturer for more details.

Figure 7. Typical application with a crystal oscillator

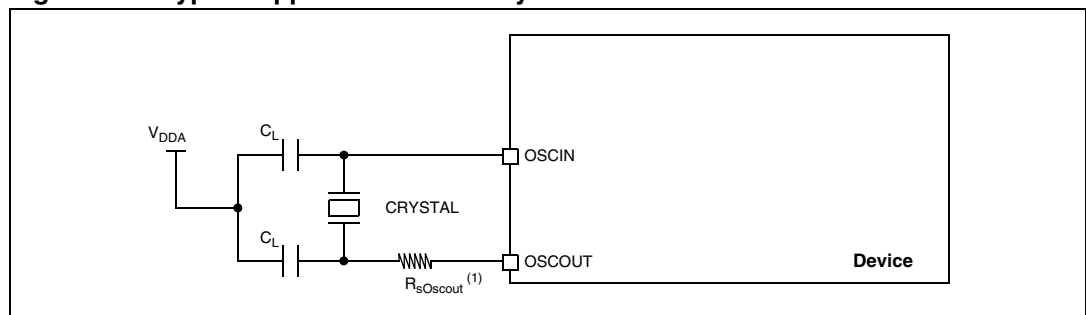

1. Depending on the crystal oscillator power dissipation, a serial resistor $R_{sOscout}$ may be added. Refer to the crystal oscillator manufacturer for more details.

Table 15. Typical C_L and R_S values by crystal oscillator

Supplier	Typical crystal oscillator	C_L (pF)	$R_{sOscout}$ (Ω)
NDK	AT51 or AT41	16	560

7.6 EMC characteristics

Susceptibility tests are performed on a sample basis during product characterization.

7.6.1 Functional EMS (electromagnetic susceptibility)

Based on a simple running application on the product (toggling 2 LEDs through I/O ports), the product is stressed by two electromagnetic events until a failure occurs (indicated by the LEDs).

- **ESD:** Electrostatic discharge (positive and negative) is applied on all pins of the device until a functional disturbance occurs. This test conforms with the IEC 1000-4-2 standard.
- **FTB:** A Burst of Fast Transient voltage (positive and negative) is applied to V_{DD33} and V_{SS33} through a 100pF capacitor, until a functional disturbance occurs. This test conforms with the IEC 1000-4-4 standard.

A device reset allows normal operations to be resumed. The test results are given in the table below based on the EMS levels and classes defined in application note AN1709.

Designing hardened software to avoid noise problems

EMC characterization and optimization are performed at component level with a typical application environment and simplified MCU software. It should be noted that good EMC performance is highly dependent on the user application and the software in particular.

Therefore it is recommended that the user applies EMC software optimization and prequalification tests in relation with the EMC level requested for his application.

Software recommendations

The software flowchart must include the management of runaway conditions such as:

- Corrupted program counter
- Unexpected reset
- Critical Data corruption (control registers...)

Prequalification trials

Most of the common failures (unexpected reset and program counter corruption) can be reproduced by manually forcing a low state on the $\overline{\text{RESET}}$ pin or the Oscillator pins for 1 second.

To complete these trials, ESD stress can be applied directly on the device, over the range of specification values. When unexpected behavior is detected, the software can be hardened to prevent unrecoverable errors occurring (see application note AN1015).

Table 16. EMC characterization and optimization values

Symbol	Parameter	Conditions	Level/Class
V_{FESD}	Voltage limits to be applied on any I/O pin to induce a functional disturbance	$V_{DD33} = 3.3 \text{ V}$, $T_A = +25 \text{ }^\circ\text{C}$, $f_{OSC} = 12 \text{ MHz}$ complies with IEC 1000-4-2 specifications	4B
V_{FFTB}	Fast transient voltage burst limits to be applied through 100pF on V_{DD33} and V_{SS33} pins to induce a functional disturbance	$V_{DD33} = 3.3 \text{ V}$, $T_A = +25 \text{ }^\circ\text{C}$, $f_{OSC} = 12 \text{ MHz}$ complies with IEC 1000-4-4 specifications	4A

7.6.2 Electromagnetic interference (EMI)

Based on a simple application running on the product (toggling 2 LEDs through the I/O ports), the product is monitored in terms of emission. This emission test is in line with the norm SAE J 1752/3 which specifies the board and the loading of each pin.

Table 17. Electromagnetic interference

Symbol	Parameter	Conditions ⁽¹⁾	Monitored Frequency Band	Max vs. [f _{osc} @12 MHz]	Unit
S _{EMI}	Peak level	V _{DD33} = 3.3 V, T _A = +25 °C, complies with SAE J 1752/3 specifications	0.1 MHz to 30 MHz	20	dB μ V
			30 MHz to 130 MHz	25	
			130 MHz to 1 GHz	25	
			SAE EMI Level	4	-

1. Refer to Application Note AN1709 for data on other package types.

7.6.3 Absolute maximum ratings (electrical sensitivity)

Based on three different tests (ESD, LU and DLU) using specific measurement methods, the product is stressed in order to determine its performance in terms of electrical sensitivity. For more details, refer to the application note AN1181.

Electrostatic discharge (ESD)

Electrostatic discharges (a positive then a negative pulse separated by 1 second) are applied to the pins of each sample according to each pin combination. The sample size depends on the number of supply pins in the device (3 parts*(n+1) supply pin). This test conforms to the JESD22-A114A/A115A standard.

Table 18. Absolute Maximum Ratings

Symbol	Ratings	Conditions	Max. ⁽¹⁾	Unit
V _{ESD(HBM)}	Electrostatic discharge voltage (Human Body Model)	T _A = +25 °C	2000	V

1. Data based on characterization results, not tested in production.

Static latch-up (LU)

3 complementary static tests are required on 10 parts to assess the latch-up performance. A supply overvoltage (applied to each power supply pin) and a current injection (applied to each input, output and configurable I/O pin) are performed on each sample. This test complies with EIA/JESD 78 IC latch-up specifications.

Table 19. Electrical sensitivity values

Symbol	Parameter	Conditions	Class ⁽¹⁾
LU	Static latch-up class	T _A = +25 °C	A

1. Class description: A Class is an STMicroelectronics internal specification. All its limits are higher than the JEDEC specifications, that means when a device belongs to Class A it exceeds the JEDEC standard. B Class strictly covers all the JEDEC criteria (international standard).

7.7 I/O port pin characteristics

7.7.1 General characteristics

Subject to general operating conditions for V_{DD33} , f_{OSC} , and T_A unless otherwise specified.

Table 20. General I/O port pin characteristics

Symbol	Parameter	Conditions	Min.	Typ.	Max.	Unit
V_{IL}	Input low level voltage	TTL ports			$0.16 \times V_{DD33}$	V
V_{IH}	Input high level voltage		$0.85 \times V_{DD33}$			
V_{hys}	Schmitt trigger voltage hysteresis ⁽¹⁾		400			mV
I_L	Input leakage current	$V_{SS} \leq V_{IN} \leq V_{DD33}$, standard I/Os			1	μA
I_{L5V}	5V tolerant input leakage current	$V_{SS} \leq V_{IN} \leq V_{DD33}$			10	
		$V_{IN} = 5V, 25^\circ C$		30		
R_{PU}	Weak pull-up equivalent resistor ⁽²⁾	$V_{IN} = V_{SS}$ $V_{DD33} = 3.3V$	32	50	75	k Ω

1. Hysteresis voltage between Schmitt trigger switching levels. Based on characterization results, not tested in production.
2. The R_{PU} pull-up equivalent resistor is based on a resistive transistor. This data is based on characterization results, tested in production at V_{DD33} max.

Figure 8. Typical V_{IL} and V_{IH} standard I/Os

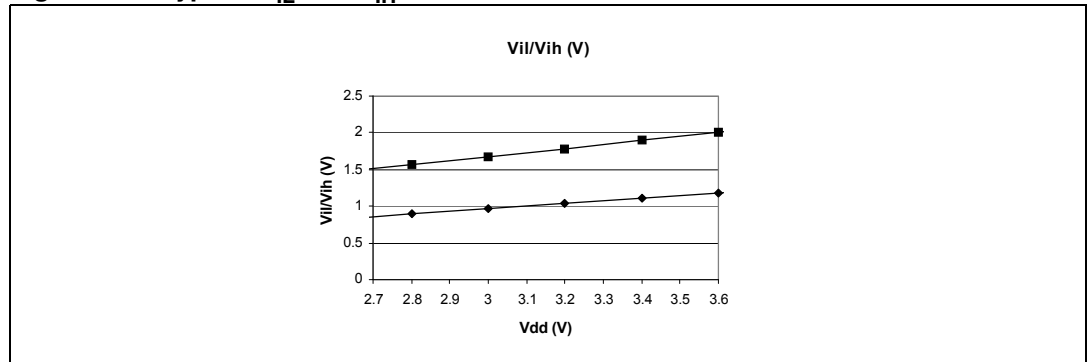

Figure 9. Typical R_{PU} vs. V_{DD33} with $V_{IN}=V_{SS}$

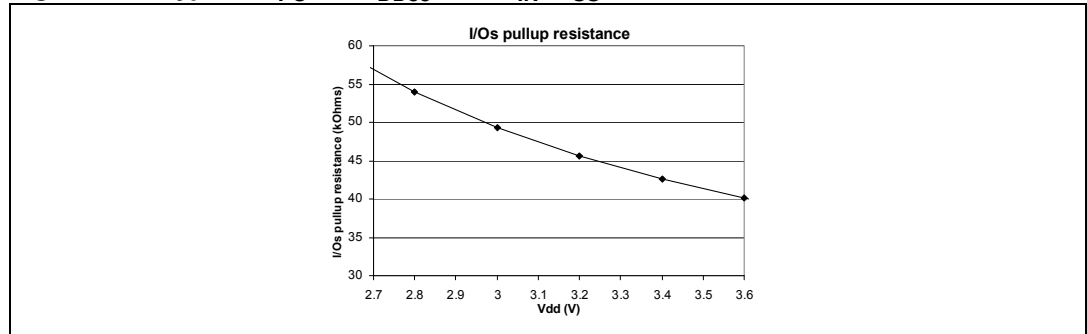
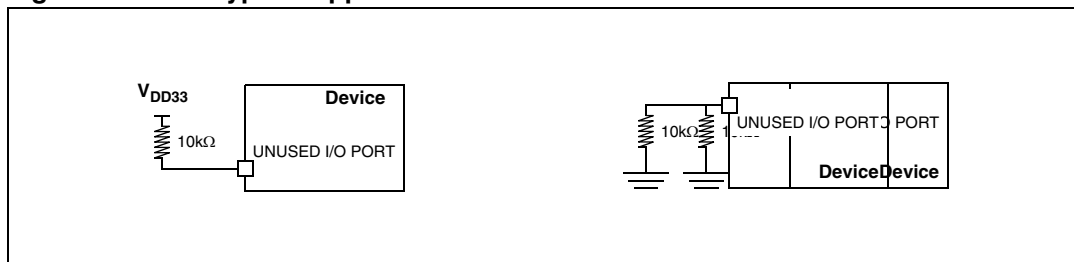

Figure 10. Two typical Applications with unused I/O Pin



7.7.2 Output driving current

Subject to general operating conditions for V_{DD33} , f_{OSC} , and T_A unless otherwise specified.

Table 21. Output driving current

Symbol	Parameter	Conditions	Min.	Max.	Unit
$V_{OL}^{(1)}$	Output low level voltage for a D2 I/O pin when 8 pins are sunk at same time (see Figure 11)	$I_{IO} = 2 \text{ mA}$		300	mV
	Output low level voltage for a D4 I/O pin when 8 pins are sunk at same time (see Figure 12)	$I_{IO} = 4 \text{ mA}$		400	
	Output low level voltage for a D8 I/O pin when 8 pins are sunk at same time (see Figure 13)	$I_{IO} = 8 \text{ mA}$		500	
V_{DD33} $V_{OH}^{(2)}$	Output high level voltage for a D2 I/O pin when 8 pins are sourced at same time (see Figure 14)	$I_{IO} = 2 \text{ mA}$		600	mV
	Output high level voltage for a D4 I/O pin when 8 pins are sourced at same time (see Figure 15)	$I_{IO} = 4 \text{ mA}$		600	
	Output high level voltage for a D8 I/O pin when 8 pins are sourced at same time (see Figure 16)	$I_{IO} = 8 \text{ mA}$		600	

- The I_{IO} current sunk must always respect the absolute maximum rating specified in [Section 7.2.2: Current characteristics](#) and the sum of I_{IO} (I/O ports and control pins) must not exceed I_{VSS} .
- The I_{IO} current sourced must always respect the absolute maximum rating specified in [Section 7.2.2: Current characteristics](#) and the sum of I_{IO} (I/O ports and control pins) must not exceed I_{VDD33} . True open drain I/O pins do not have V_{OH} .

Figure 11. Typical V_{OL} at $V_{DD33} = 3.3 \text{ V}$ (I/O D2)

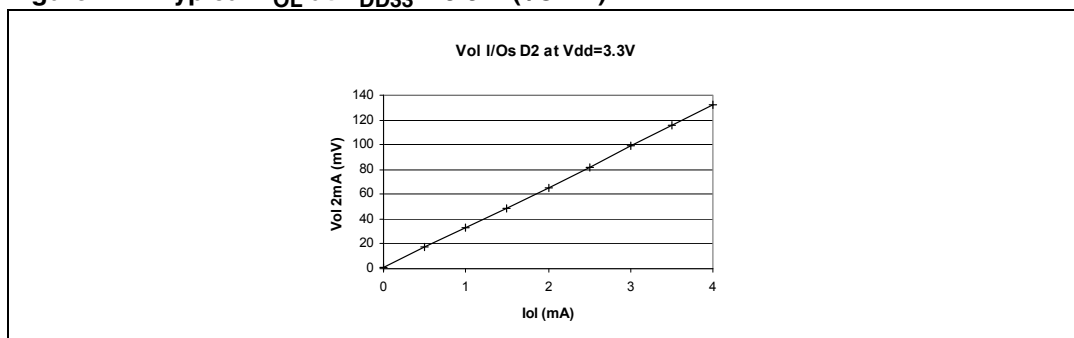

Figure 12. Typical V_{OL} at $V_{DD33} = 3.3\text{ V}$ (I/O D4)

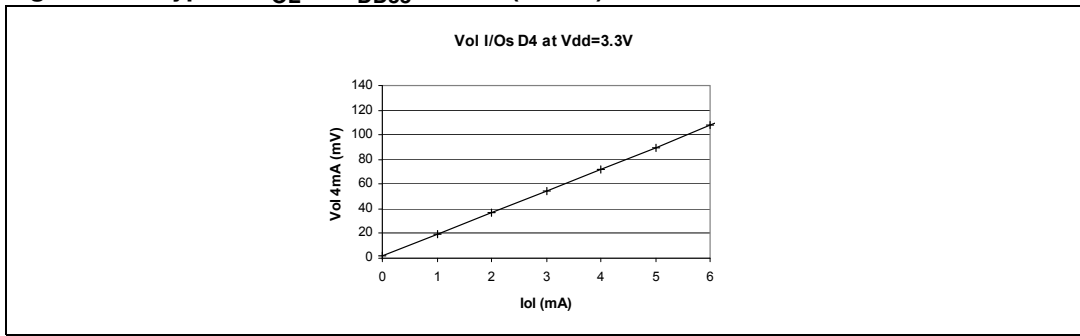

Figure 13. Typical V_{OL} at $V_{DD33} = 3.3\text{ V}$ (I/O D8)

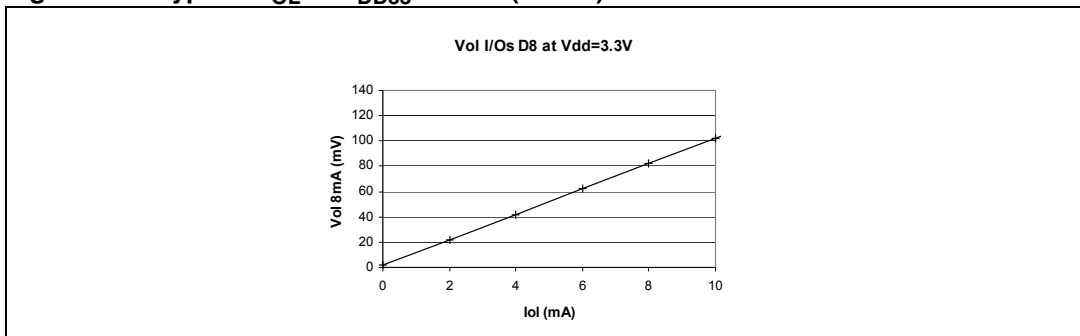

Figure 14. Typical $V_{DD33}-V_{OH}$ vs. V_{DD33} (I/O D2)

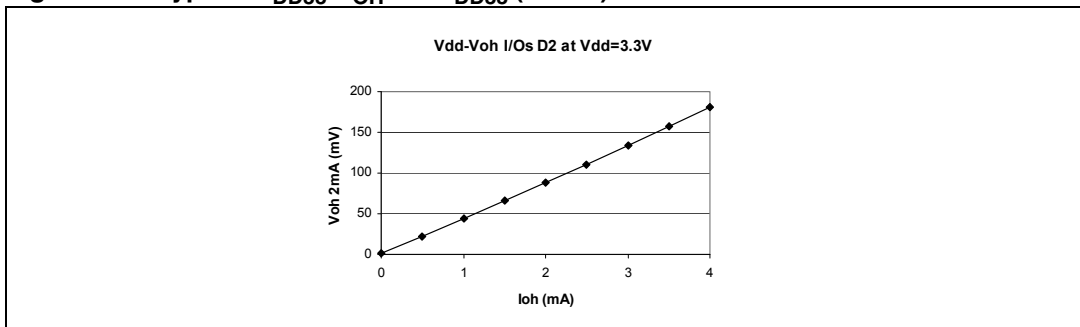

Figure 15. Typical $V_{DD33}-V_{OH}$ vs. V_{DD33} (I/O D4)

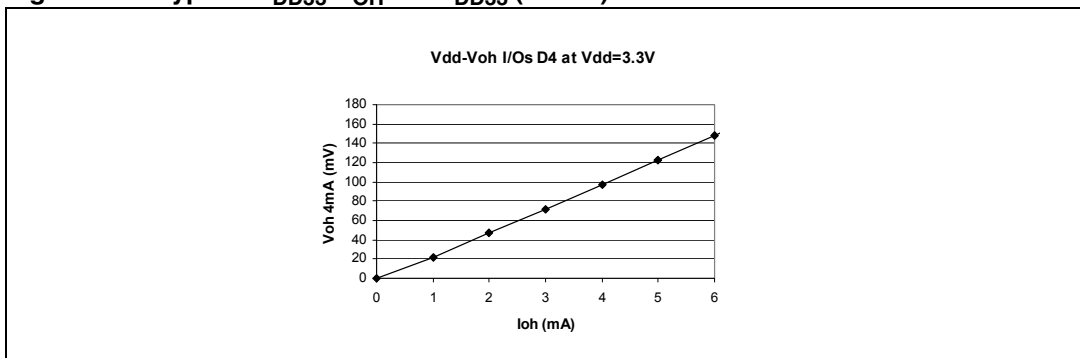
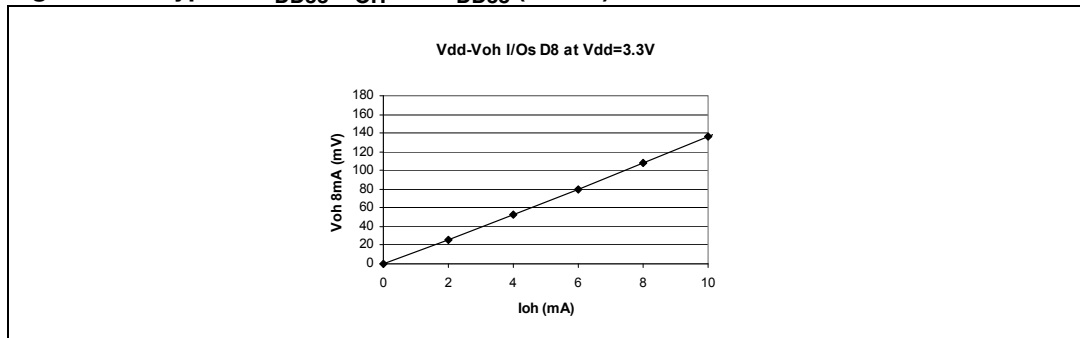

Figure 16. Typical V_{DD33} - V_{OH} vs. V_{DD33} (I/O D8)

7.8 Control pin characteristics

7.8.1 Asynchronous $\overline{\text{RESET}}$ pin

$T_A = 0$ to $+55$ °C unless otherwise specified.

Table 22. $\overline{\text{RESET}}$ pin characteristics

Symbol	Parameter	Conditions	Min.	Typ.	Max.	Unit
V_{IL}	Input low level voltage ⁽¹⁾				$0.16 \times V_{DD33}$	V
V_{IH}	Input high level voltage		$0.85 \times V_{DD33}$			
V_{hys}	Schmitt trigger voltage hysteresis			450		mV
R_{ON}	Pull-up equivalent resistor	$V_{DD33} = 3.3$ V	20	40	80	k Ω
		$V_{DD33} = 2$ V		100		
$t_{eh}(\text{RSTL})$	External reset pulse hold time ⁽²⁾		2.5			μs
$t_g(\text{RSTL})$	Filtered glitch duration ⁽³⁾			200		ns
$t_{ew}(\text{RSTL})$	External reset pulse duration ⁽⁴⁾		500			μs
$t_{iw}(\text{RSTL})$	Internal reset pulse duration			2		t_{CPU}

1. The level on the $\overline{\text{RESET}}$ pin must be free to go below the V_{IL} max. level specified in [Section 7.8.1: Asynchronous RESET pin](#). Otherwise the reset will not be taken into account internally.
2. To guarantee the reset of the Device, a minimum pulse has to be applied to the $\overline{\text{RESET}}$ pin. All short pulses applied on RESET pin with a duration below $t_{eh}(\text{RSTL})$ can be ignored. Not tested in production, guaranteed by design.
3. The reset network protects the device against parasitic resets.
4. The external reset duration must respect this timing to guarantee a correct start-up of the internal regulator at power-up. Not tested in production, guaranteed by design.

Figure 17. Typical R_{ON} on \overline{RESET} pin

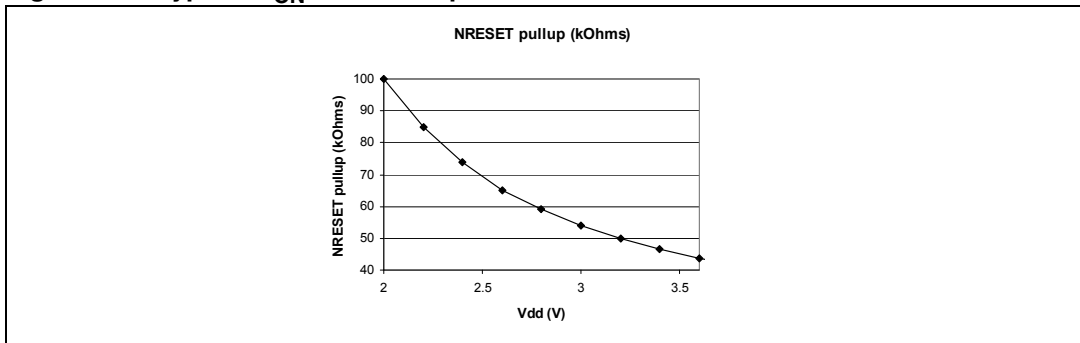

7.9 Other communication interface characteristics

7.9.1 MSCI parallel interface

Figure 18. Timing diagrams for input mode (with max load on CTRL signal = 50 pF)

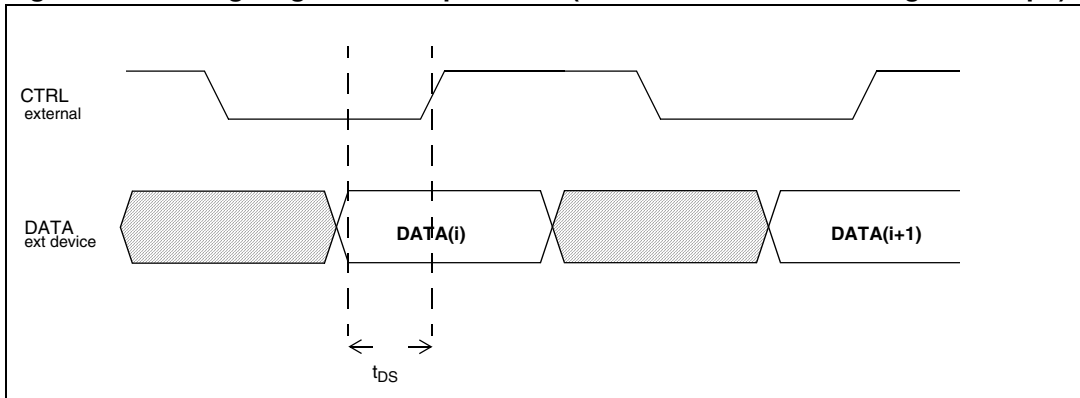

1. t_{DS} is the setup time for data sampling.

Figure 19. Timing diagrams for output mode (with max CTRL signal = 50 pF, DATA)

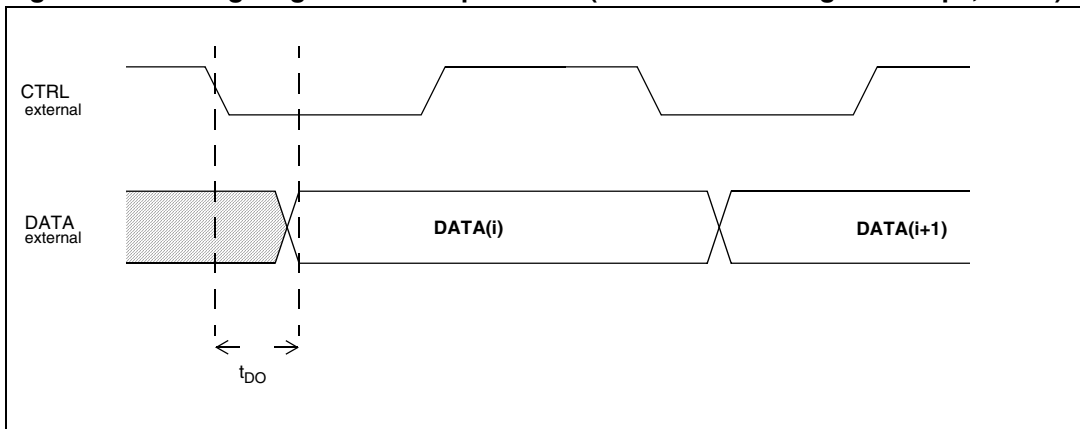

1. t_{DO} is the data output time for data sampling.

Table 23. MSCI Parallel Interface: DC Characteristics

Symbol	Parameter	Conditions	Min.	Typ. ⁽¹⁾	Max.	Unit
t_{DS}	Data Setup Time			11		ns
t_{DO}	Data Output time			6		ns
C_{CTRL}	CTRL line capacitance			50		pF
C_{DATA}	Data line capacitance			50		pF

1. Data based on design simulation and not tested in production.

7.9.2 Universal serial bus interface (USB)

Table 24. DC characteristics

Symbol	Parameter	Conditions	Min.	Typ.	Max.	Unit
$I_{DDsuspend}$	Suspend current	$V_{DD33} = 3.3\text{ V}$, Power-down mode, 25 °C ⁽¹⁾	60	90	190	μA
R_{PU}	Pull-up resistor ⁽²⁾			1.5		k Ω
Full speed mode						
V_{TERM}	Termination voltage		0.8		2.0	V
V_{OH}	High level output voltage		2.8		3.6	V
V_{OL}	Low level output voltage				0.8	V
V_{CRS}	Crossover voltage		1.3		2.0	V
High speed mode						
V_{HSOH}	HS data signalling high			400		mV
V_{HSOL}	HS data signalling low			5		mV

1. The values provided do not take into account the current through both the 1.5k Ω pull-up resistor (on the device-side) and the 15k Ω pull-down resistor (on the host-side).

2. Not tested in production, guaranteed by characterization.

Table 25. Timing characteristics

Symbol	Parameter	Conditions	Min.	Max.	Unit
Full speed mode					
t_{FR}	Rise time	$C_L = 50\text{ pF}$	4	20	ns
t_{FF}	Fall time	$C_L = 50\text{ pF}$	4	20	ns
High speed mode					
t_{HSR}	Rise time			500 ⁽¹⁾	ps
t_{HSF}	Fall time			500 ⁽¹⁾	ps
t_{HSDRAT}	HS data rate		479.76	480.24	Mb/s

1. Not tested in production, guaranteed by characterization.

Table 26. USB High Speed Transmit Waveform requirements

	Voltage Level (DP - DN)	Time
Unit Interval (UI)	-	2.082 to 2.084 ns
Level 1	475 mV	-
Level 2	-475 mV	-
Point 1	0V	5% UI
Point 2	0V	95% UI
Point 3	300 mV	35% UI
Point 4	300 mV	65% UI
Point 5	-300 mV	35% UI
Point 6	-300 mV	65% UI

Figure 20. USB signal eye diagram

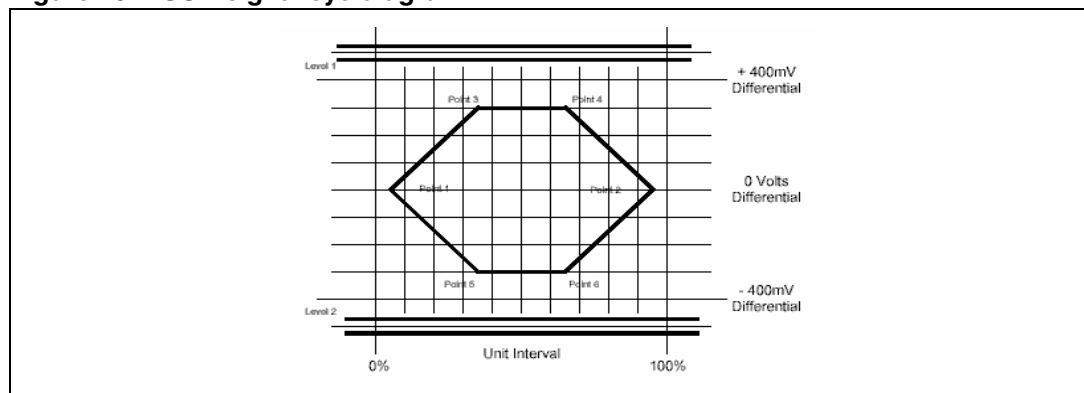

8 Package mechanical data

In order to meet environmental requirements, ST offers this device in different grades of ECOPACK[®] packages, depending on their level of environmental compliance. ECOPACK[®] specifications, grade definitions and product status are available at: www.st.com. ECOPACK[®] is an ST trademark.

Figure 21. 48-pin low profile quad flat package outline

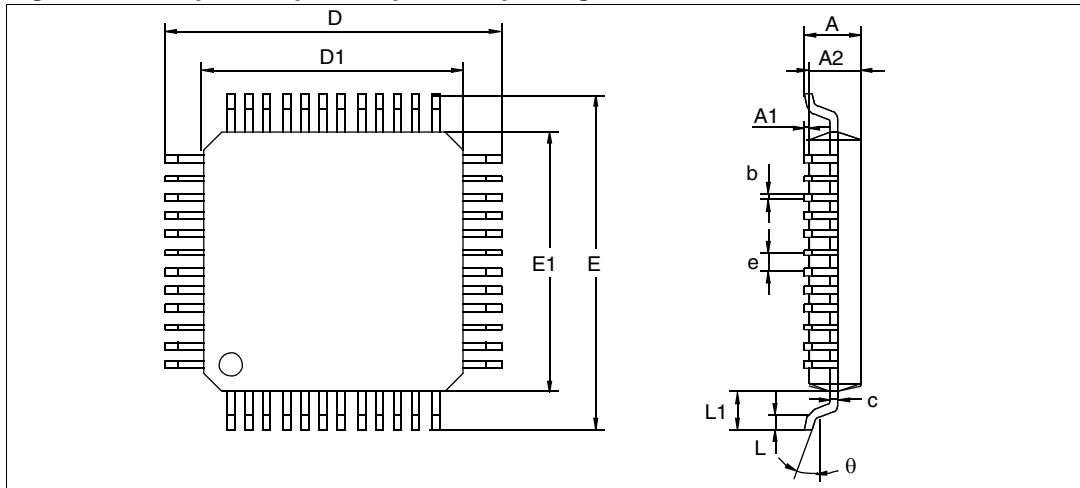

Table 27. 48-pin low profile quad flat package dimensions

Dim.	mm			inches ⁽¹⁾		
	Min.	Typ.	Max.	Min.	Typ.	Max.
A			1.60			0.0630
A1	0.05		0.15	0.0020		0.0060
A2	1.35	1.40	1.45	0.0530	0.0550	0.0570
b	0.17	0.22	0.27	0.0070	0.0090	0.0110
C	0.09		0.20	0.0040		0.0080
D		9.00			0.3540	
D1		7.00			0.2760	
E		9.00			0.3540	
E1		7.00			0.2760	
e		0.50			0.0200	
θ	0°	3.5°	7°	0°	3.5°	7°
L	0.45	0.60	0.75	0.0180	0.0240	0.0300
L1		1.00			0.0390	
	Number of Pins					
N	48					

1. Values in inches are converted from mm and rounded to 4 decimal digits.

9 Device ordering information

Table 28. Feature comparison table

Features added in the ST72681/R21 versus ST72681/R20	Description
Support for up to 4 NAND Flash devices	Firmware revision R21 upgrades the number of supported NAND Flash devices from 1 to 4 in a single channel.
Continued AutoRun CDROM partition support	AutoRun runs a program when the USB Flash Drive is inserted into a computer.

Table 29. Ordering information

Part number	Package	Operating voltage	Temperature range
ST72681/R20	LQFP48 7x7mm	3.0 to 3.6 V	0 to +70 °C
ST72681/R21 (latest firmware revision)	LQFP48 7x7mm	3.0 to 3.6 V	0 to +70 °C

10 Revision history

Table 30. Document revision history

Date	Revision	Changes
27-May-2005	1.0	<p>Changed status of the document</p> <p>Changed description on 1st page</p> <p>Removed unconnected pins in Table 5 on page 7</p> <p>Changed Table 4 on page 6</p> <p>Changed pin 5 description in Table 3 on page 6</p> <p>Changed section 3 on page 7</p> <p>Changed Figure 3 on page 8 and Figure 4</p>
18-Nov-2005	2.0	<p>Electrical Characteristics section added, Section 4 on page 10</p> <p>Additional features listed on front page</p> <p>Status of document changed to Datasheet</p> <p>Application schematics modified, Figure 4 removed</p> <p>Section 4.6 (Memory Characteristics) removed</p> <p>VDDOUSB marked as O (output) in Table 2 on page 6</p>
06-Feb-2006	3.0	<p>Additional features listed on front page</p> <p>Application schematics modified, Figure 3 on page 8</p> <p>Feature comparison table added for R20 firmware update, Table 28</p> <p>Figure 3 on page 8 updated, with note added</p>
09-Jan-2007	4.0	<p>Additional features listed on front page related to firmware release R21. Application schematics updated for R21, Figure 3 on page 8</p> <p>Feature comparison table added for R21 firmware update, Table 28</p> <p>$I_{DDsuspend}$ values and note updated, Table 24</p>
30-Aug-2007	5.0	<p>Updated information in Table 6: Known NAND Flash compatibility guide for R20 and R21 devices on page 10.</p> <p>Added Section 4.2: NAND error correction on page 11, Section 4.3: Management of bad NAND Flash blocks on page 11, Section 4.4: Wear levelling on page 12 and Section 4.5: NAND Flash interface configuration on page 13.</p> <p>Added Section 5: Mass storage implementation on page 14 and Section 6: Human interface implementation on page 16.</p> <p>Added internal clock frequency (f_{CPU}) value in Table 10: General operating conditions on page 19.</p>
22-Jan-2009	6	<p>Updated datasheet status to "not recommended for new design".</p> <p>Replaced ST by Numonyx for NAND Flash memories. Updated mass storage in Section : Features. Added Note 2 below Table 6.</p> <p>Removed dynamic latch-up in Section 7.6.3: Absolute maximum ratings (electrical sensitivity).</p> <p>Changed TQFP48 to LQFP48.</p> <p>Updated ECOPACK text in Section 8: Package mechanical data.</p>

Please Read Carefully:

Information in this document is provided solely in connection with ST products. STMicroelectronics NV and its subsidiaries ("ST") reserve the right to make changes, corrections, modifications or improvements, to this document, and the products and services described herein at any time, without notice.

All ST products are sold pursuant to ST's terms and conditions of sale.

Purchasers are solely responsible for the choice, selection and use of the ST products and services described herein, and ST assumes no liability whatsoever relating to the choice, selection or use of the ST products and services described herein.

No license, express or implied, by estoppel or otherwise, to any intellectual property rights is granted under this document. If any part of this document refers to any third party products or services it shall not be deemed a license grant by ST for the use of such third party products or services, or any intellectual property contained therein or considered as a warranty covering the use in any manner whatsoever of such third party products or services or any intellectual property contained therein.

UNLESS OTHERWISE SET FORTH IN ST'S TERMS AND CONDITIONS OF SALE ST DISCLAIMS ANY EXPRESS OR IMPLIED WARRANTY WITH RESPECT TO THE USE AND/OR SALE OF ST PRODUCTS INCLUDING WITHOUT LIMITATION IMPLIED WARRANTIES OF MERCHANTABILITY, FITNESS FOR A PARTICULAR PURPOSE (AND THEIR EQUIVALENTS UNDER THE LAWS OF ANY JURISDICTION), OR INFRINGEMENT OF ANY PATENT, COPYRIGHT OR OTHER INTELLECTUAL PROPERTY RIGHT.

UNLESS EXPRESSLY APPROVED IN WRITING BY AN AUTHORIZED ST REPRESENTATIVE, ST PRODUCTS ARE NOT RECOMMENDED, AUTHORIZED OR WARRANTED FOR USE IN MILITARY, AIR CRAFT, SPACE, LIFE SAVING, OR LIFE SUSTAINING APPLICATIONS, NOR IN PRODUCTS OR SYSTEMS WHERE FAILURE OR MALFUNCTION MAY RESULT IN PERSONAL INJURY, DEATH, OR SEVERE PROPERTY OR ENVIRONMENTAL DAMAGE. ST PRODUCTS WHICH ARE NOT SPECIFIED AS "AUTOMOTIVE GRADE" MAY ONLY BE USED IN AUTOMOTIVE APPLICATIONS AT USER'S OWN RISK.

Resale of ST products with provisions different from the statements and/or technical features set forth in this document shall immediately void any warranty granted by ST for the ST product or service described herein and shall not create or extend in any manner whatsoever, any liability of ST.

ST and the ST logo are trademarks or registered trademarks of ST in various countries.

Information in this document supersedes and replaces all information previously supplied.

The ST logo is a registered trademark of STMicroelectronics. All other names are the property of their respective owners.

© 2009 STMicroelectronics - All rights reserved

STMicroelectronics group of companies

Australia - Belgium - Brazil - Canada - China - Czech Republic - Finland - France - Germany - Hong Kong - India - Israel - Italy - Japan - Malaysia - Malta - Morocco - Singapore - Spain - Sweden - Switzerland - United Kingdom - United States of America

www.st.com