

## Common mode filter with ESD protection for high speed serial interface

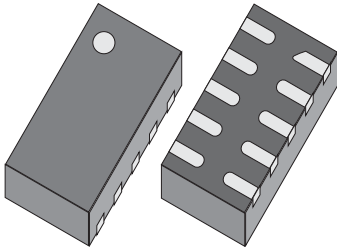

QFN-10L 2.6 x 1.35 x 0.5

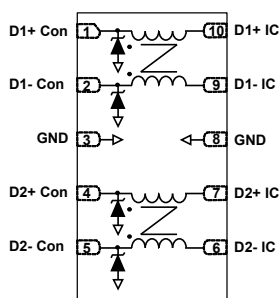

### Features

- Very large differential bandwidth to comply with HDMI Full HD, MIPI, USB2.0, USB3.2 Gen 1, Display Port and other high speed serial interfaces
- Provides -20 dB attenuation at 700 MHz in LTE bands
- High common mode attenuation:- 25 dB between 800 MHz - 900 MHz
- Low PCB space consumption
- Thin package for compact applications: 0.55 mm max.
- High reduction of parasitic elements through integration
- RoHS package

### Complies with the following standards

- IEC 61000-4-2, level 4:
  - ±15 kV (air discharge)
  - ±8 kV (contact discharge)

### Applications

- Mobile phones
- Notebook, laptop
- Portable devices
- PND

### Description

The **ECMF04-4HSM10** is a highly integrated common mode filter designed to suppress EMI/RFI common mode noise on high speed differential serial buses like HDMI Full HD, MIPI, Display Port and other high speed serial interfaces.

The device has a very large differential bandwidth to comply with these standards and can protect and filter two differential lanes.

#### Product status link

[ECMF04-4HSM10](#)

#### Product summary

Order code	ECMF04-4HSM10
------------	---------------

# 1 Characteristics

**Table 1. Absolute maximum ratings ( $T_{amb} = 25\text{ }^{\circ}\text{C}$ )**

Symbol	Parameter	Value	Unit	
$V_{PP}$	Peak pulse voltage	IEC 61000-4-2: Contact discharge	8	kV
		Air discharge	16	
$I_{RMS}$	Maximum RMS current	100	mA	
$T_{op}$	Operating ambient temperature range	-55 to +125	$^{\circ}\text{C}$	
$T_j$	Maximum junction temperature	125		
$T_{stg}$	Storage temperature range	-55 to +150		

**Figure 1. Electrical characteristics (definitions)**

$V_{RM}$  Maximum stand-off voltage  
 $V_{CL}$  Clamping voltage at peak pulse current  $I_{pp}$   
 $I_{RM}$  Leakage current at  $V_{RM}$   
 $I_{PP}$  Peak pulse current  
 $V_{BR}$  Breakdown voltage  
 $R_{DC}$  DC serial resistance  
 $f_C$  Differential cut off frequency

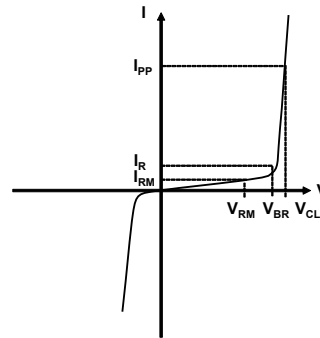
**Table 2. Electrical characteristics ( $T_{amb} = 25\text{ }^{\circ}\text{C}$ )**

Symbol	Test conditions	Min.	Typ.	Max.	Unit
$V_{BR}$	$I_R = 1\text{ mA}$	6			V
$I_{RM}$	$V_{RM} = 3\text{ V per line}$			100	nA
$R_{DC}$	DC serial resistance		5		$\Omega$

**Table 3. Pin description**

Pin number	Description	Pin number	Description
1	D1+ to connector	6	D2- to IC
2	D1- to connector	7	D2+ to IC
3	GND	8	GND
4	D2+ to connector	9	D1- to IC
5	D2- to connector	10	D1+ to IC

## 1.1 Characteristics (curves)

**Figure 2. Differential attenuation versus frequency**  
( $Z_{0\_DIFF} = 100 \Omega$ )

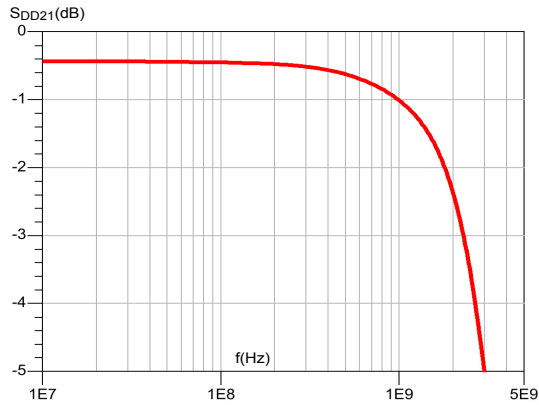

**Figure 3. Common mode attenuation versus frequency**  
( $Z_{0\_COM} = 50 \Omega$ )

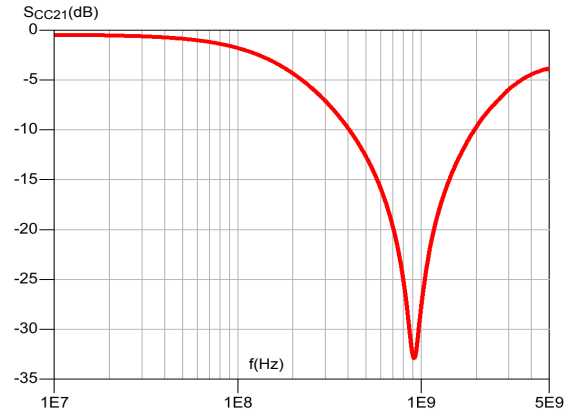

**Figure 4. ESD response to IEC61000-4-2 (+8 kV contact discharge)**

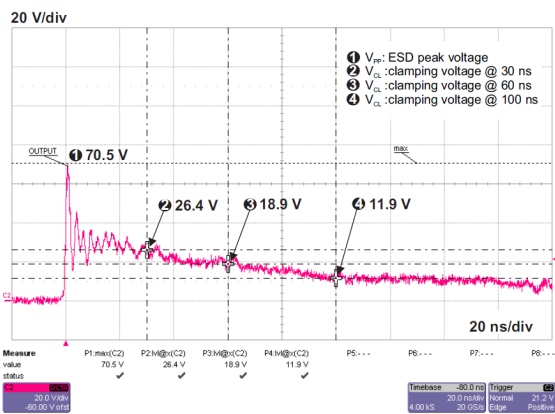

**Figure 5. ESD response to IEC61000-4-2 (-8 kV contact discharge)**

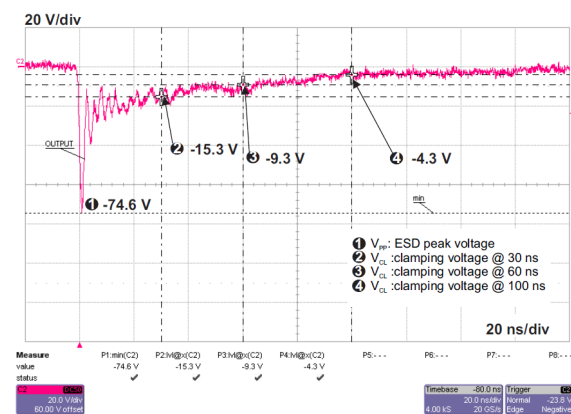

**Figure 6. HDMI1.4 3.35 Gbps eye diagram without ECMF04-4HSM10**

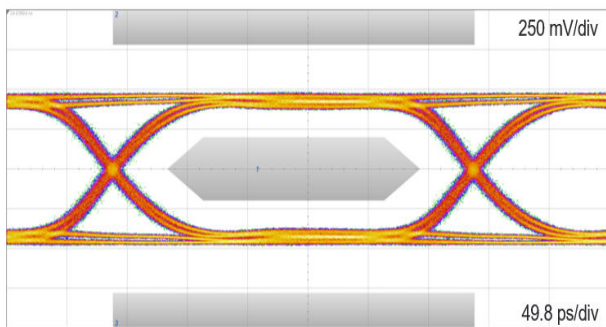

**Figure 7. HDMI1.4 3.35 Gbps eye diagram with ECMF04-4HSM10**

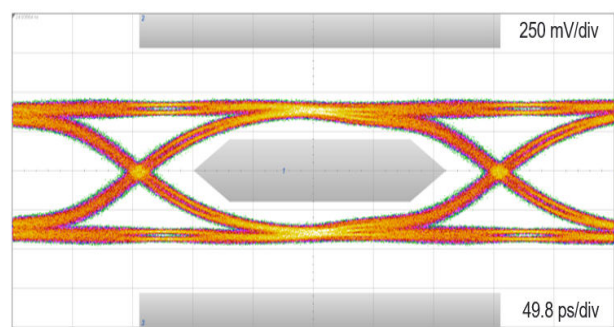

**Figure 8. USB2.0 480 Mbps eye diagram without device**

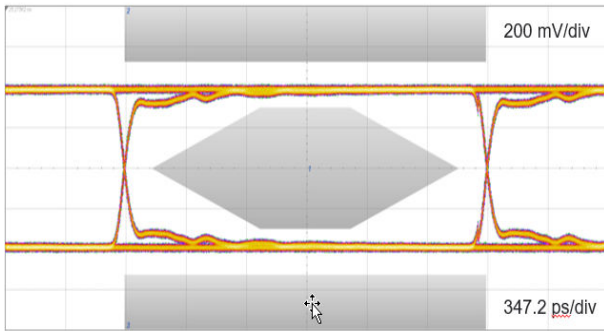

**Figure 9. USB2.0 480 Mbps eye diagram with device**

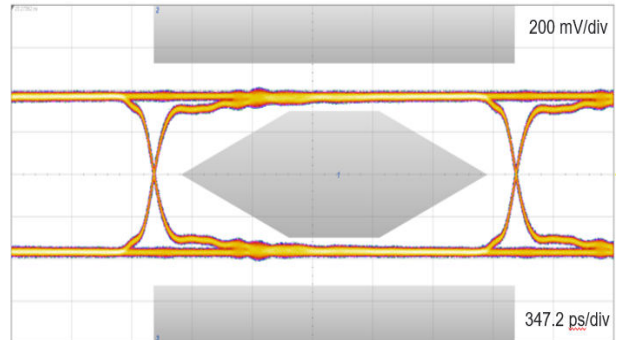

**Figure 10. USB3.2 Gen 1 5.0 Gbps eye diagram without ECMF04-4HSM10 (with worst cable and equalizer)**

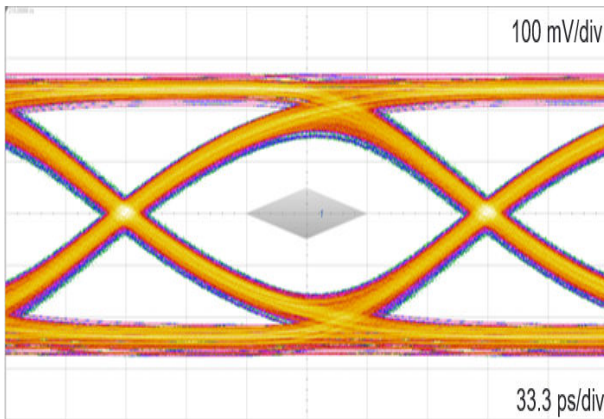

**Figure 11. USB3.2 Gen 1 5.0 Gbps eye diagram with ECMF04-4HSM10 (with worst cable and equalizer)**

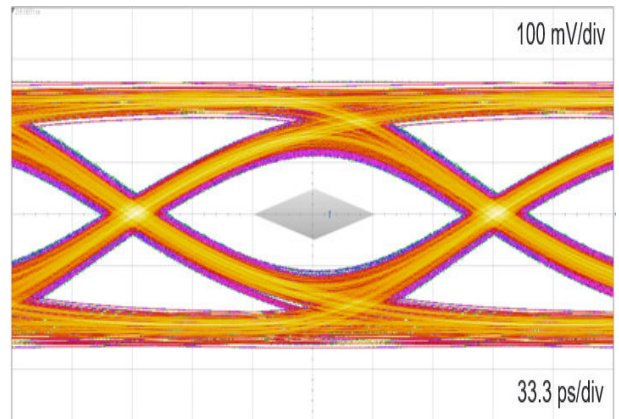

**Figure 12. MIPI D-PHY 2.5 Gbps long reference channel eye diagram without ECMF04-4HSM10**

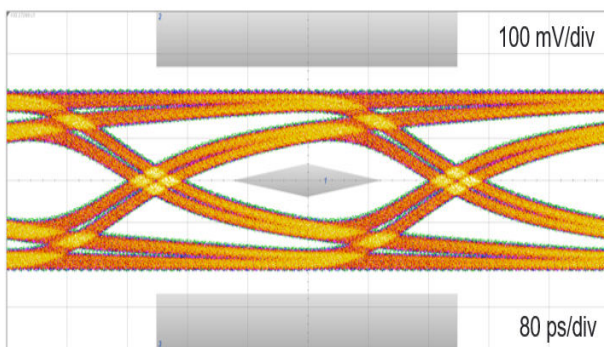

**Figure 13. MIPI D-PHY 2.5 Gbps long reference channel eye diagram with ECMF04-4HSM10**

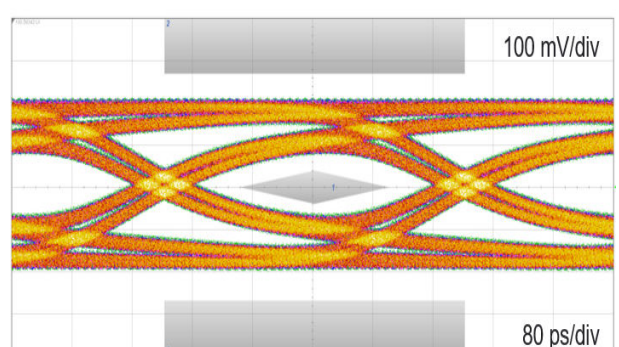
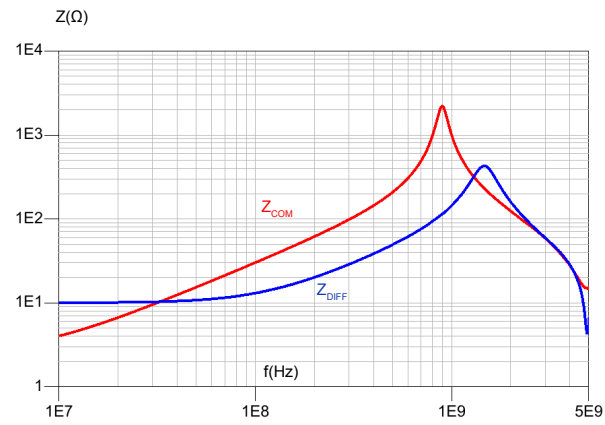
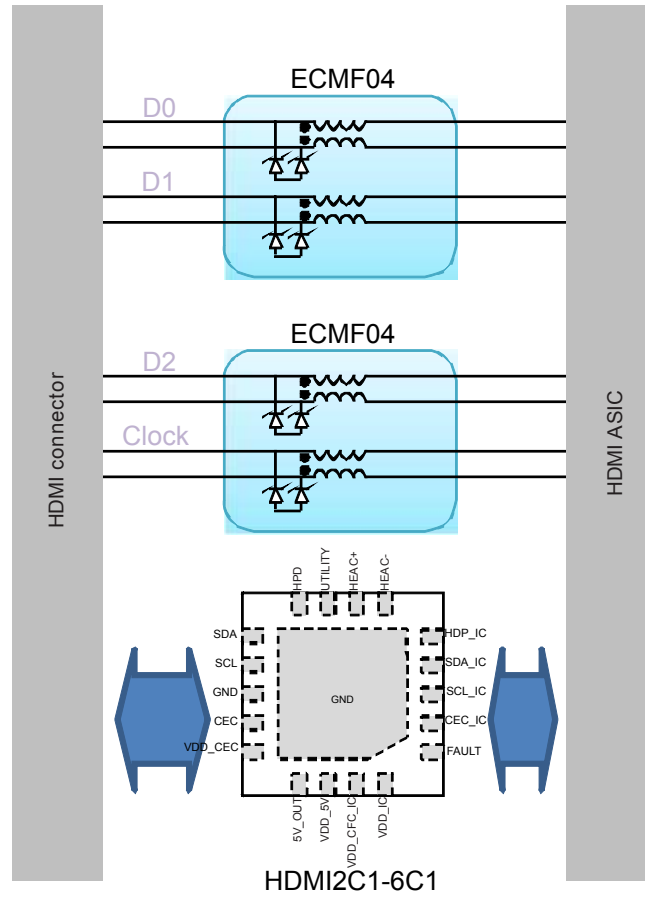

Figure 14. Differential and common mode impedance versus frequency



## 2 Application information

Figure 15. HDMI schematic



More application information available in following AN:

- [AN4356](#): "Antenna desense on handheld equipment"
- [AN4511](#): "Common mode filters"
- [AN4540](#): "MHL link filtering and protection"

### 3 Package information

To meet environmental requirements, ST offers these devices in different grades of **ECOPACK** packages, depending on their level of environmental compliance. ECOPACK specifications, grade definitions, and product status are available at: [www.st.com](http://www.st.com). ECOPACK is an ST trademark.

#### 3.1 QFN-10L package information

Figure 16. QFN10L package outline

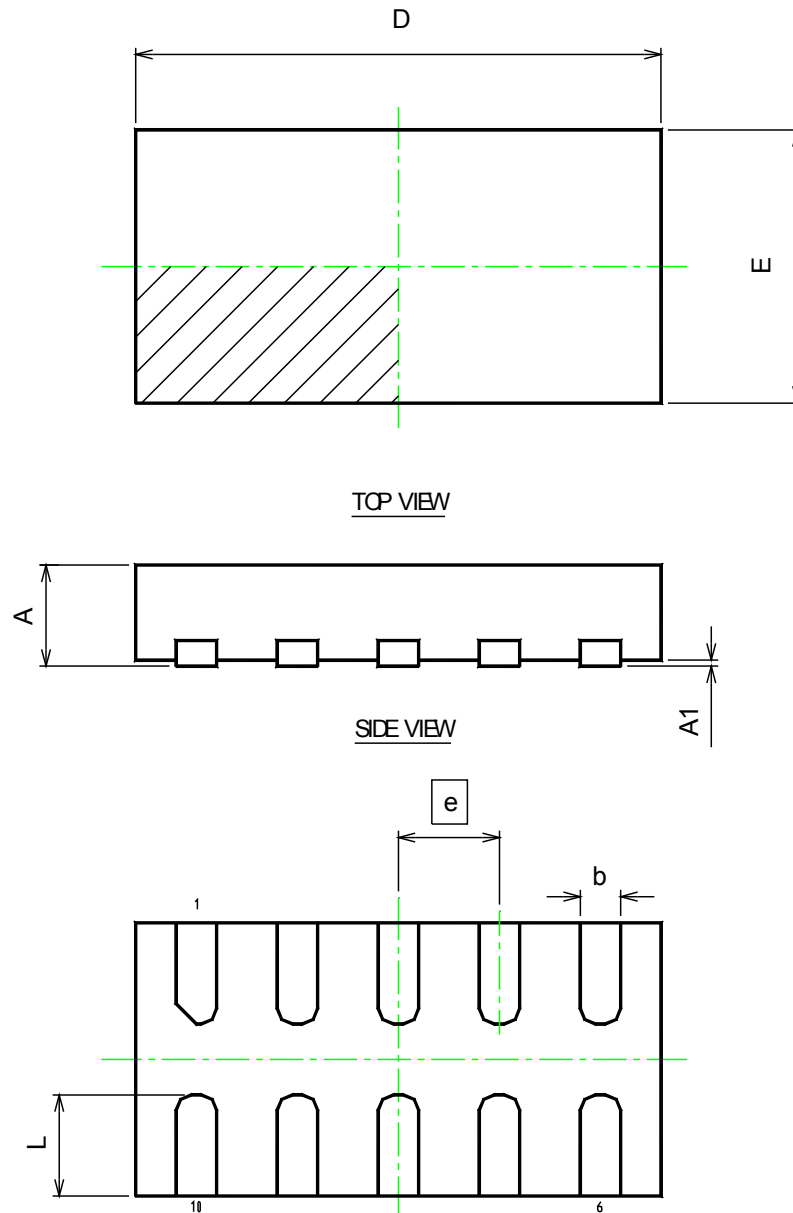

**Table 4. QFN10L package mechanical data**

Ref.	Dimensions		
	Millimeters		
	Min.	Typ.	Max.
A	0.45	0.50	0.55
A1	0.00	0.02	0.05
b	0.15	0.20	0.25
D	2.55	2.60	2.65
E	1.30	1.35	1.40
e		0.50	
L	0.40	0.50	0.60

**Figure 17. Footprint recommendations (mm)**

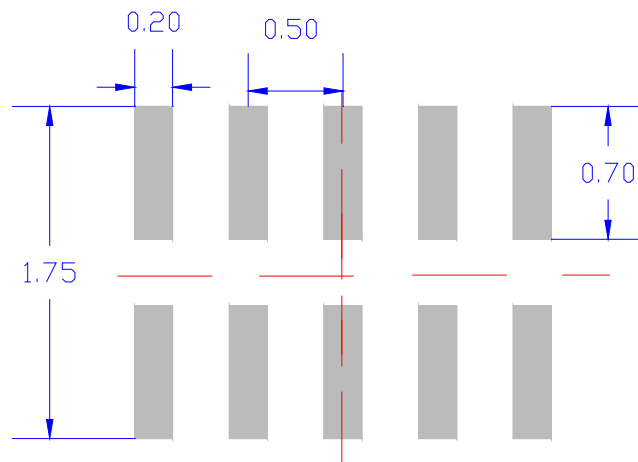



## **4 PCB assembly recommendation**

---

### **4.1 Solder paste**

1. Halide-free flux qualification ROL0 according to ANSI/J-STD-004.
2. "No clean" solder paste is recommended.
3. Offers a high tack force to resist component movement during high speed.
4. Use solder paste with fine particles: powder particle size is 20-38  $\mu\text{m}$ .

## 4.2 QFN-10L packing information

Figure 18. Marking



Dot indicates pin 1  
XX: Marking

Figure 19. Package orientation in reel

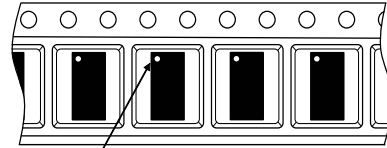

Pin 1 located according to EIA-481

Note: Pocket dimensions are not on scale  
Pocket shape may vary depending on package

Figure 20. Tape and reel orientation

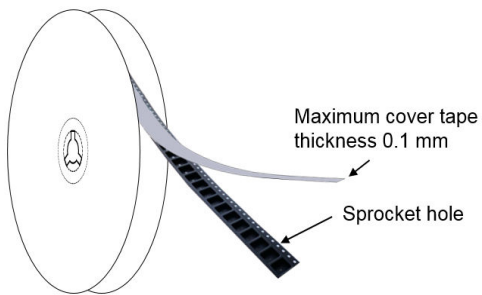

Figure 21. Reel dimensions (mm)

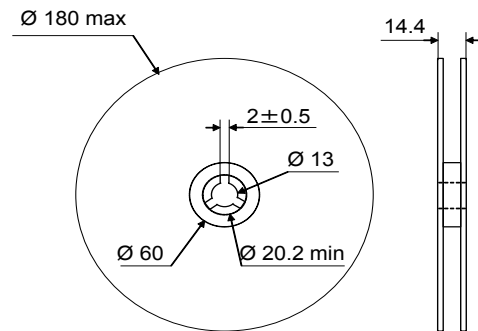

Figure 22. Inner box dimensions (mm)

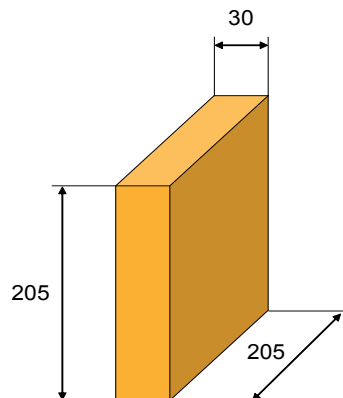
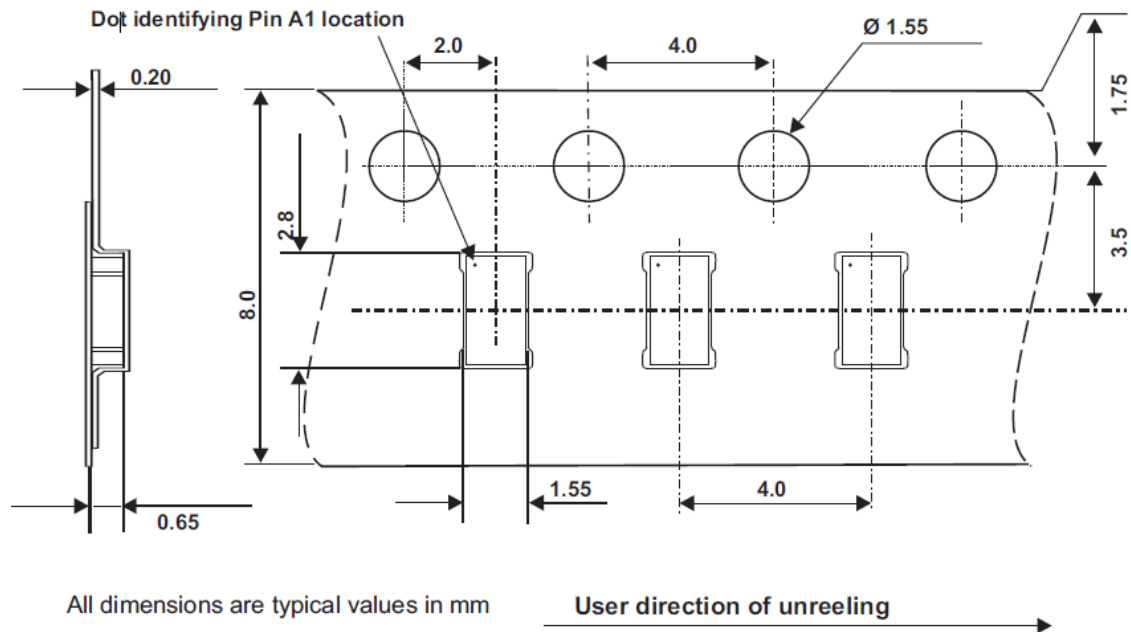
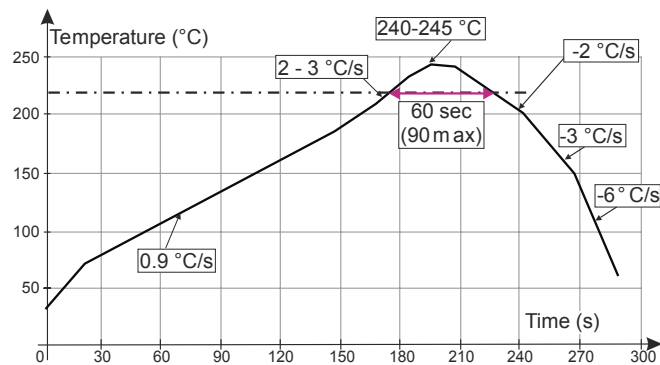

Figure 23. Tape and reel outline



### 4.3 Solder reflow

Figure 24. ST ECOPACK® recommended soldering reflow profile for PCB mounting



Note: Minimize air convection currents in the reflow oven to avoid component movement. Maximum soldering profile corresponds to the latest IPC/JEDEC J-STD-020.

## 5 Ordering information

Figure 25. Ordering information scheme

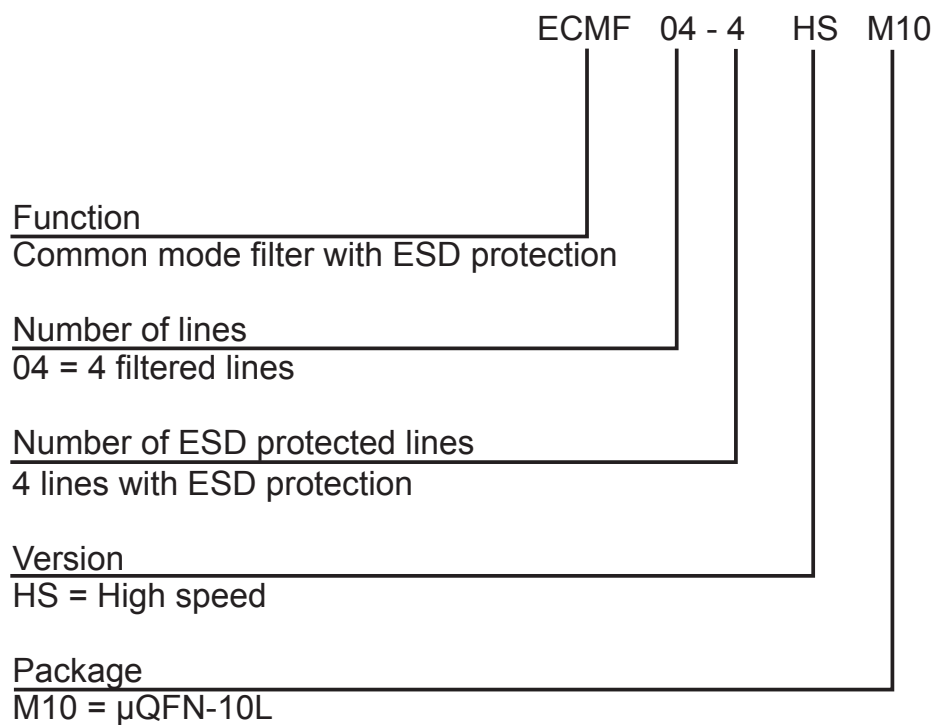

Order code	Marking	Package	Weight	Base qty.	Delivery mode
ECMF04-4HSM10	KK <sup>(1)</sup>	$\mu$ QFN-10L	5 mg	3000	Tape and reel

1. The marking can be rotated by 90° to differentiate assembly location

## Revision history

**Table 5. Document revision history**

Date	Version	Changes
03-Oct-2013	1	Initial release.
25-Aug-2014	2	Added <i>Figure 5: Differential (ZDD21) and common mode (ZCC21) impedance versus frequency.</i>
13-Dec-2017	3	Updated <i>Table 1.</i>
09-Nov-2020	4	Updated <i>Figure 6, Figure 7, Figure 8, Figure 9, Figure 10 and Figure 11.</i> Added <i>Figure 12 and Figure 13.</i>
27-Jan-2025	5	Removed TDR figure, and removed PCB recommendation figures.
25-Feb-2025	6	Updated <a href="#">Section Functional schematic.</a>

**IMPORTANT NOTICE – READ CAREFULLY**

STMicroelectronics NV and its subsidiaries (“ST”) reserve the right to make changes, corrections, enhancements, modifications, and improvements to ST products and/or to this document at any time without notice. Purchasers should obtain the latest relevant information on ST products before placing orders. ST products are sold pursuant to ST’s terms and conditions of sale in place at the time of order acknowledgment.

Purchasers are solely responsible for the choice, selection, and use of ST products and ST assumes no liability for application assistance or the design of purchasers’ products.

No license, express or implied, to any intellectual property right is granted by ST herein.

Resale of ST products with provisions different from the information set forth herein shall void any warranty granted by ST for such product.

ST and the ST logo are trademarks of ST. For additional information about ST trademarks, refer to [www.st.com/trademarks](http://www.st.com/trademarks). All other product or service names are the property of their respective owners.

Information in this document supersedes and replaces information previously supplied in any prior versions of this document.

© 2025 STMicroelectronics – All rights reserved