

600 W TVS in DO-15

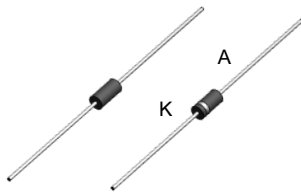

DO-15 (JEDEC DO-204AC)

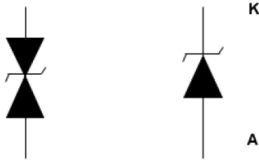

Bidirectional
(CA type)

Unidirectional
(A type)

Features

- Peak pulse power:
 - 600 W (10/1000 μ s)
 - up to 4 kW (8/20 μ s)
- Stand-off voltage range from 5.8 V to 376 V
- Unidirectional and bidirectional types
- Operating T_j max: 175 °C
- High power capability at T_j max.: up to 300 W (10/1000 μ s)
- Lead finishing: matte tin plating

Complies with the following standards

- UL94, V0
- J-STD-020 MSL level 1
- J-STD-002, JESD 22-B102 E3 and MIL-STD-750, method 2026
- JESD-201 class 2 whisker test
- UL 497B file number: QVGQ2.E136224
- IEC 61000-4-4 level 4:
 - 4 k V
- IEC 61000-4-2, C = 150 pF, R = 330 Ω exceeds level 4:
 - 30 kV (air discharge)
 - 30 kV (contact discharge)

Description

The P6KE TVS series is designed to protect sensitive equipment against electrostatic discharges according to IEC 61000-4-2, MIL STD 883 Method 3015, and electrical overstress such as IEC 61000-4-4 and 5. They are used for surges below 600 W 10/1000 μ s.

This planar technology makes it compatible with high-end equipment and SMPS where low leakage current and high junction temperature are required to provide reliability and stability over time.

Product status link

| | |
|-----------|------------|
| P6KE6V8A, | P6KE6V8CA, |
| P6KE12A, | P6KE12CA, |
| P6KE15A, | P6KE15CA, |
| P6KE18A, | P6KE18CA, |
| P6KE27A, | P6KE27CA, |
| P6KE30A, | P6KE30CA, |
| P6KE33A, | P6KE33CA, |
| P6KE36A, | P6KE36CA, |
| P6KE39A, | P6KE39CA, |
| P6KE47A, | P6KE47CA, |
| P6KE150A, | P6KE150CA, |
| P6KE180A, | P6KE180CA, |
| P6KE200A, | P6KE200CA, |
| P6KE220A, | P6KE220CA, |
| P6KE250A, | P6KE250CA, |
| P6KE300A, | P6KE300CA, |
| P6KE400A, | P6KE400CA, |
| P6KE440A, | P6KE440CA. |

1 Characteristics

Table 1. Absolute maximum ratings ($T_{amb} = 25\text{ }^{\circ}\text{C}$)

| Symbol | Parameter | Value | Unit | |
|-----------|--|---|-------------|--------------------|
| V_{PP} | Peak pulse voltage | IEC 61000-4-2 (C = 150 pF, R = 330 Ω) | | |
| | | Contact discharge | 30 | kV |
| | Air discharge | 30 | | |
| P_{PP} | Peak pulse power dissipation | 10/1000 μs , T_j initial = T_{amb} | 600 | W |
| I_{FSM} | Non repetitive surge peak forward current for unidirectional types | $t_p = 10\text{ ms}$, T_j initial = T_{amb} | 100 | A |
| T_{stg} | Storage temperature range | | -65 to +175 | $^{\circ}\text{C}$ |
| T_j | Operating junction temperature range | | -55 to +175 | $^{\circ}\text{C}$ |
| T_L | Maximum lead temperature for soldering during 10 s at 5 mm from case | | 260 | $^{\circ}\text{C}$ |

Figure 1. Electrical characteristics - parameter definitions

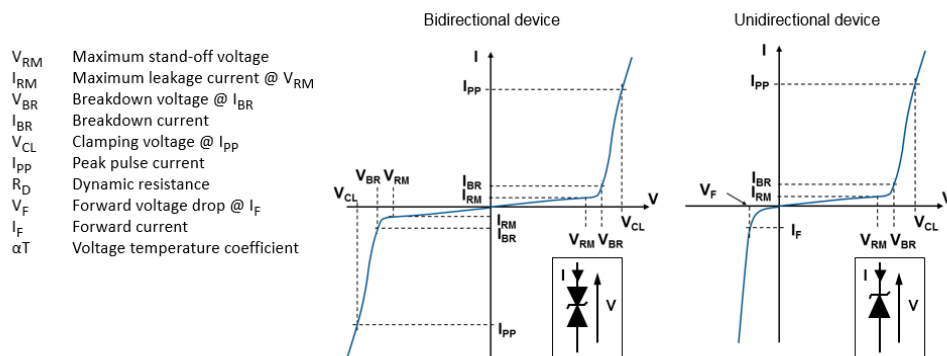

Figure 2. Pulse definition for electrical characteristics

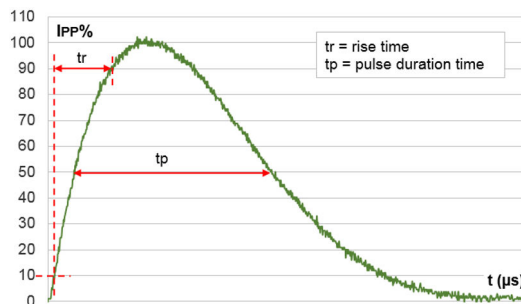

Table 2. Electrical characteristics - parameter values ($T_{amb} = 25\text{ }^{\circ}\text{C}$, unless otherwise specified)

| Type | I_{RM} max at V_{RM} | | V_{BR} at $I_{BR}^{(1)}$ | | | | 10 / 1000 μs | | | 8 / 20 μs | | | αT |
|-------------|--------------------------|-----|----------------------------|------|------|----|-------------------------|----------------|----------|----------------------|----------------|----------|----------------------------|
| | | | | | | | $V_{CL}^{(2)(3)}$ | $I_{PP}^{(4)}$ | R_D | $V_{CL}^{(2)(3)}$ | $I_{PP}^{(4)}$ | R_D | |
| | 25 $^{\circ}\text{C}$ | | Min. | Typ. | Max. | | Max. | | Max. | Max. | Max. | | |
| | μA | V | V | | | mA | V | A | Ω | V | A | Ω | $10^{-4}/^{\circ}\text{C}$ |
| P6KE6V8A/CA | 10 | 5.8 | 6.45 | 6.8 | 7.14 | 10 | 10.5 | 57 | 0.059 | 13.4 | 298 | 0.021 | 5.7 |
| P6KE12A/CA | 0.5 | 10 | 11.4 | 12 | 12.6 | 1 | 16.7 | 36 | 0.114 | 21.7 | 184 | 0.049 | 7.8 |
| P6KE15A/CA | 0.5 | 13 | 14.3 | 15 | 15.8 | 1 | 21.2 | 28 | 0.193 | 27.2 | 147 | 0.078 | 8.4 |
| P6KE18A/CA | 0.5 | 15 | 17.1 | 18 | 18.9 | 1 | 25.2 | 24 | 0.263 | 32.5 | 123 | 0.111 | 8.8 |
| P6KE27A/CA | 0.5 | 23 | 25.7 | 27 | 28.4 | 1 | 37.5 | 16 | 0.569 | 48.5 | 83 | 0.240 | 9.6 |
| P6KE30A/CA | 0.5 | 26 | 28.5 | 30 | 31.5 | 1 | 41.5 | 14.5 | 0.690 | 53.5 | 75 | 0.293 | 9.7 |
| P6KE33A/CA | 0.5 | 28 | 31.4 | 33 | 34.7 | 1 | 45.7 | 13.1 | 0.840 | 59 | 68 | 0.357 | 9.8 |
| P6KE36A/CA | 0.5 | 31 | 34.2 | 36 | 37.8 | 1 | 49.9 | 12 | 1.01 | 64.3 | 62 | 0.427 | 9.9 |
| P6KE39A/CA | 0.5 | 33 | 37.1 | 39 | 41.0 | 1 | 53.9 | 11.1 | 1.16 | 69.7 | 57 | 0.504 | 10.0 |
| P6KE47A/CA | 0.5 | 40 | 44.7 | 47 | 49.4 | 1 | 64.8 | 9.3 | 1.66 | 84 | 48 | 0.721 | 10.1 |
| P6KE150A/CA | 0.5 | 128 | 143 | 150 | 158 | 1 | 207 | 2.9 | 16.9 | 265 | 15 | 7.13 | 10.8 |
| P6KE180A/CA | 0.5 | 154 | 171 | 180 | 189 | 1 | 246 | 2.4 | 23.8 | 317 | 12.6 | 10.2 | 10.8 |
| P6KE200A/CA | 0.5 | 171 | 190 | 200 | 210 | 1 | 274 | 2.2 | 29.1 | 353 | 11.3 | 12.7 | 10.8 |
| P6KE220A/CA | 0.5 | 188 | 209 | 220 | 231 | 1 | 328 | 1.85 | 52.4 | 388 | 10.3 | 15.2 | 10.8 |
| P6KE250A/CA | 0.5 | 213 | 237 | 250 | 263 | 1 | 344 | 1.75 | 46.3 | 442 | 9 | 19.9 | 11 |
| P6KE300A/CA | 0.5 | 256 | 285 | 300 | 315 | 1 | 414 | 1.45 | 68.3 | 529 | 7.6 | 28.2 | 11 |
| P6KE400A/CA | 0.5 | 342 | 380 | 400 | 420 | 1 | 548 | 1.1 | 116 | 706 | 5.7 | 50.2 | 11 |
| P6KE440A/CA | 0.5 | 376 | 418 | 440 | 462 | 1 | 603 | 1.0 | 141 | 776 | 5.2 | 60.4 | 11 |

1. To calculate V_{BR} versus T_j : V_{BR} at $T_j = V_{BR}$ at $25\text{ }^{\circ}\text{C} \times (1 + \alpha T \times (T_j - 25))$

2. To calculate V_{CL} versus T_j : V_{CL} at $T_j = V_{CL}$ at $25\text{ }^{\circ}\text{C} \times (1 + \alpha T \times (T_j - 25))$

3. To calculate V_{CL} max versus $I_{PPappli}$: V_{CL} max = V_{BR} max + $R_D \times I_{PPappli}$

4. Surge capability given for both directions for unidirectional (A type) and bidirectional (CA type) devices

1.1 Characteristics (curves)

Figure 3. Maximum peak power dissipation versus initial junction temperature

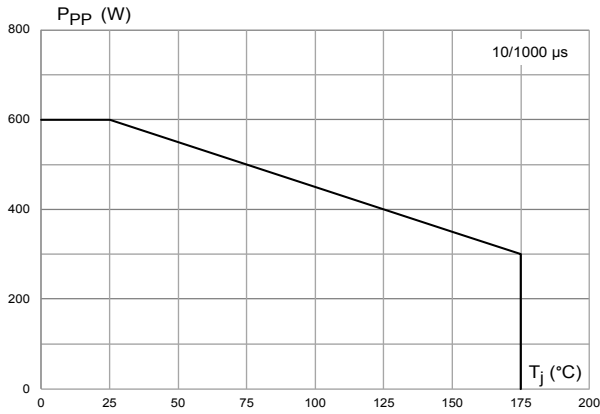

Figure 4. Maximum peak pulse power versus exponential pulse duration

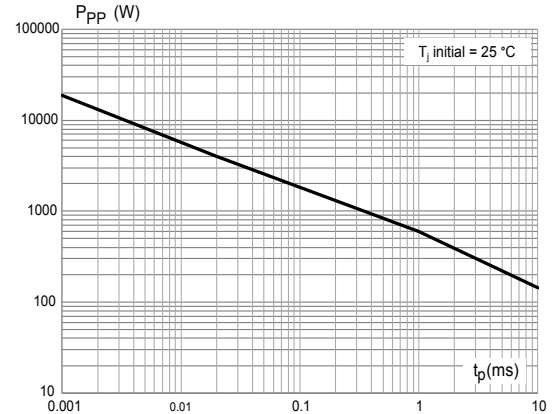

Figure 5. Maximum peak pulse current versus clamping voltage

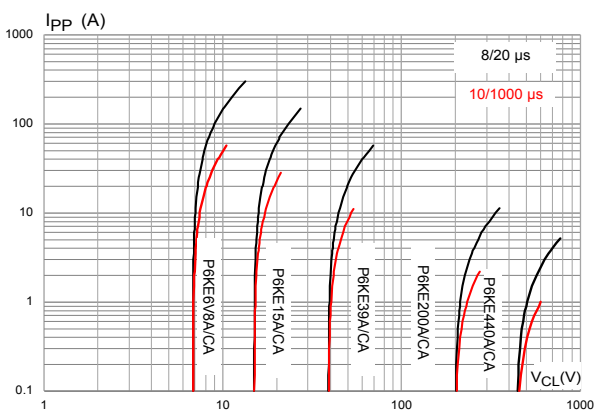

Figure 6. Dynamic resistance versus pulse duration

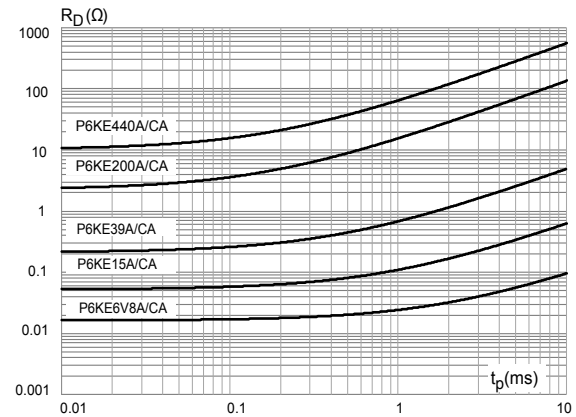

Figure 7. Junction capacitance versus reverse applied voltage (unidirectional type)

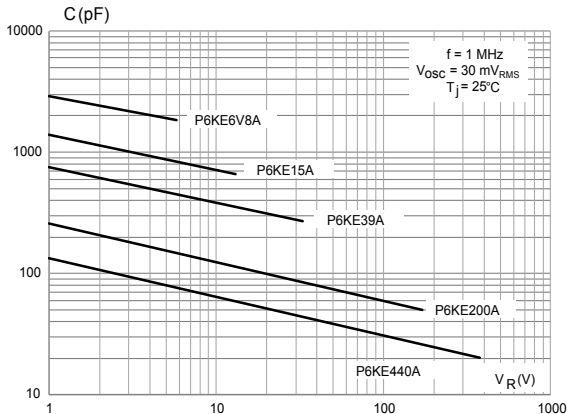

Figure 8. Junction capacitance versus applied voltage (bidirectional type)

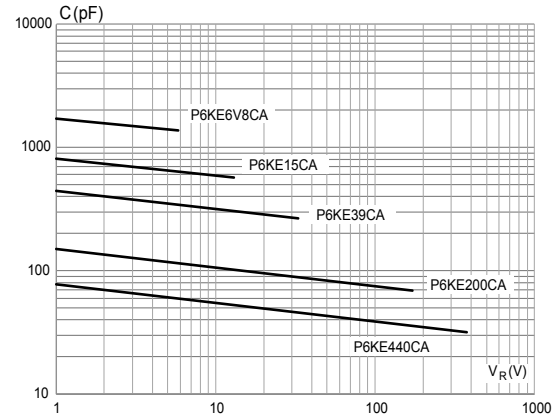

Figure 9. Leakage current versus junction temperature

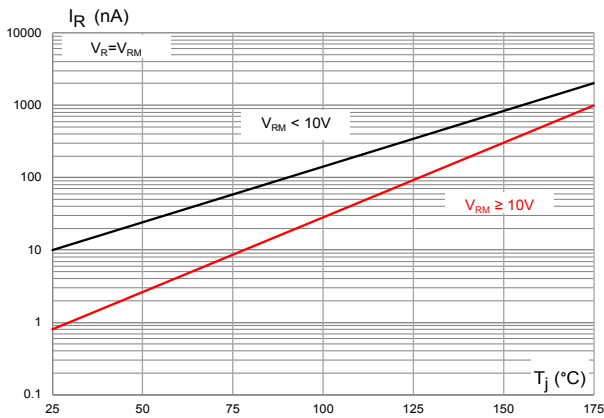

Figure 10. Peak forward voltage drop versus peak forward current

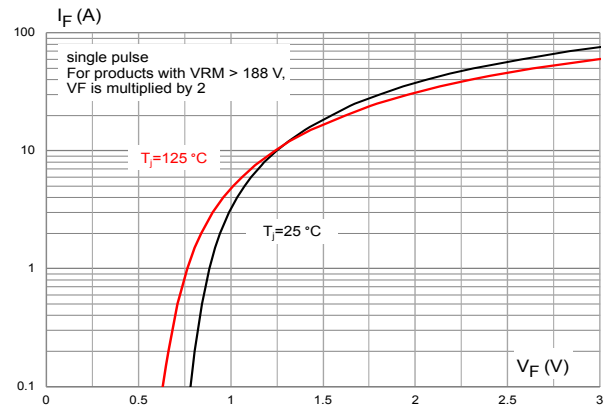

Figure 11. Thermal impedance junction to ambient versus pulse duration

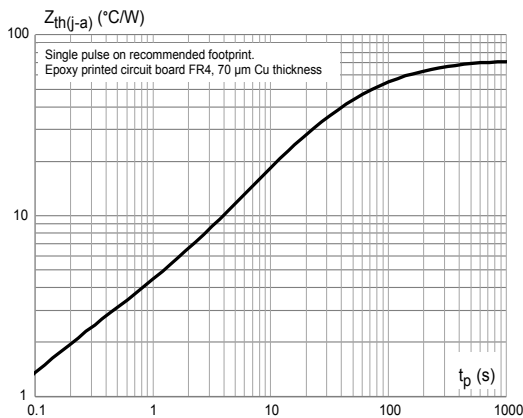
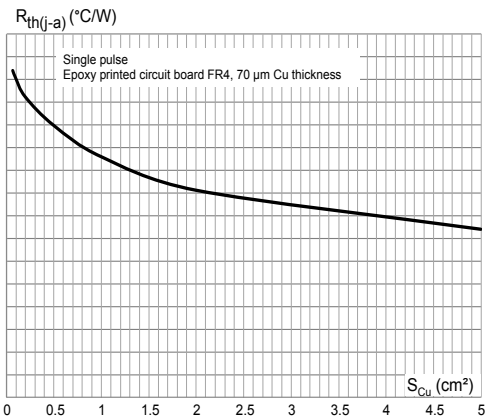

Figure 12. Thermal resistance junction to ambient versus copper area under each lead



2 Package information

To meet environmental requirements, ST offers these devices in different grades of **ECOPACK** packages, depending on their level of environmental compliance. ECOPACK specifications, grade definitions, and product status are available at: www.st.com. ECOPACK is an ST trademark.

2.1 DO-15 package information

Figure 13. DO-15 package outline

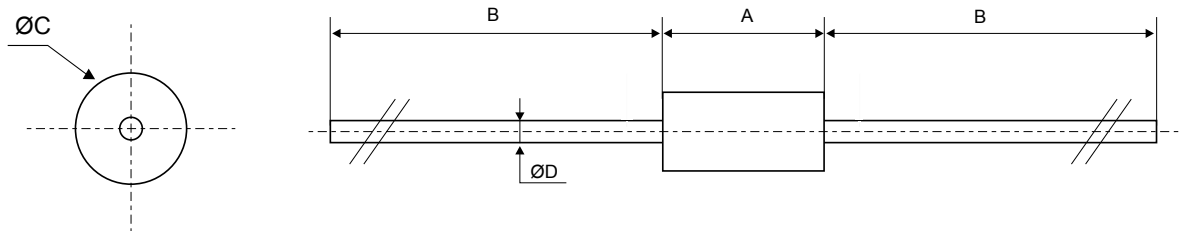

Table 3. DO-15 package mechanical data

| Ref. | Dimensions | | | | | |
|------|-------------|------|-------|-----------------------------|-------|-------|
| | Millimeters | | | Inches (for reference only) | | |
| | Min. | Typ. | Max. | Min. | Typ. | Max. |
| A | 6.05 | 6.40 | 6.75 | 0.238 | 0.252 | 0.266 |
| B | 26.00 | 28.5 | 31.00 | 1.023 | 1.122 | 1.221 |
| C | 2.95 | 3.24 | 3.53 | 0.116 | 0.128 | 0.139 |
| D | 0.71 | 0.80 | 0.88 | 0.027 | 0.031 | 0.035 |

Figure 14. Marking layout

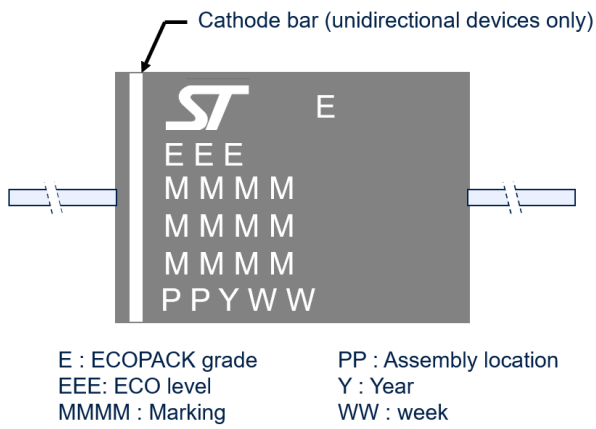

Figure 15. Tape and reel orientation

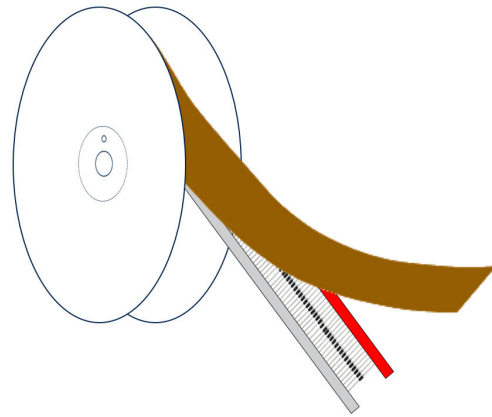

Figure 16. Reel dimension values (mm)

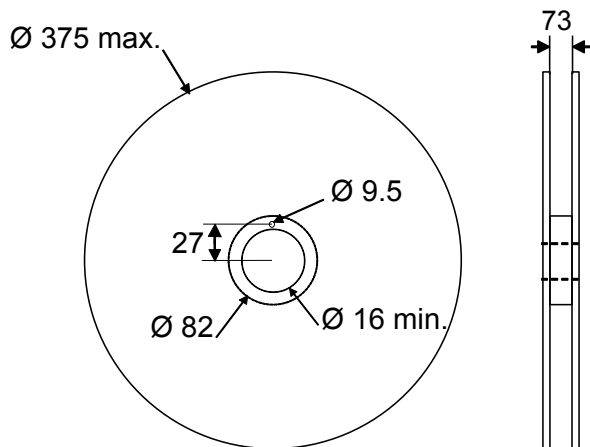

Figure 17. Inner box dimension values (mm)

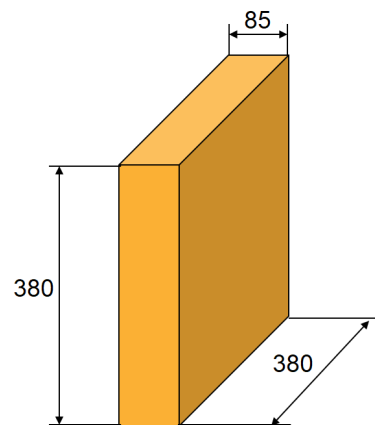

Figure 18. Ammopack dimension values (mm)

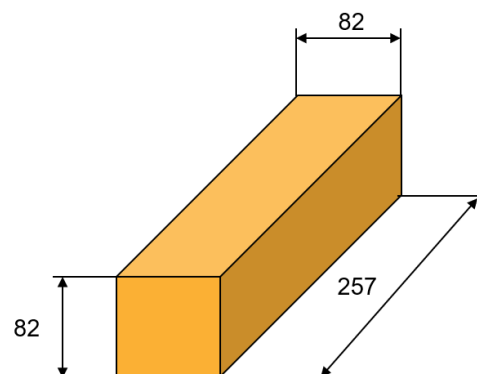
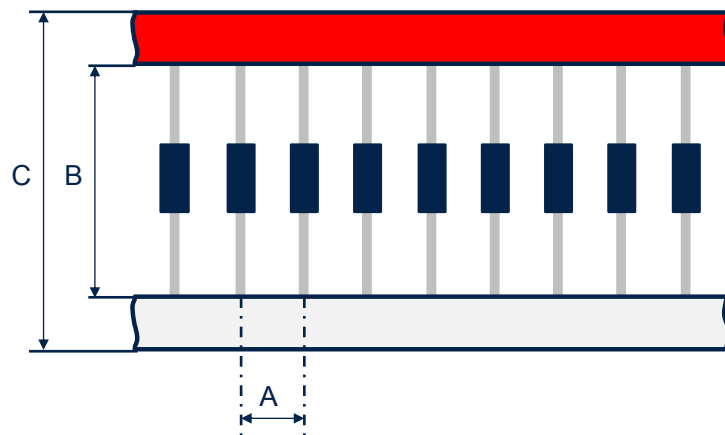

Figure 19. Tape outline



Dimensions are not to scale

Unidirectional components are oriented with red tape on the cathode and white tape on the anode. Bidirectional components have red tape on both sides.

Table 4. Tape dimension values

| Ref. | Dimensions | | |
|------|-------------|------|------|
| | Millimeters | | |
| | Min. | Typ. | Max. |
| A | 4.5 | 5 | 5.5 |
| B | 51 | 53 | 55 |
| C | 62 | 65 | 68 |

2.2 Reflow profile

Figure 20. ST ECOPACK recommended soldering reflow profile for PCB mounting

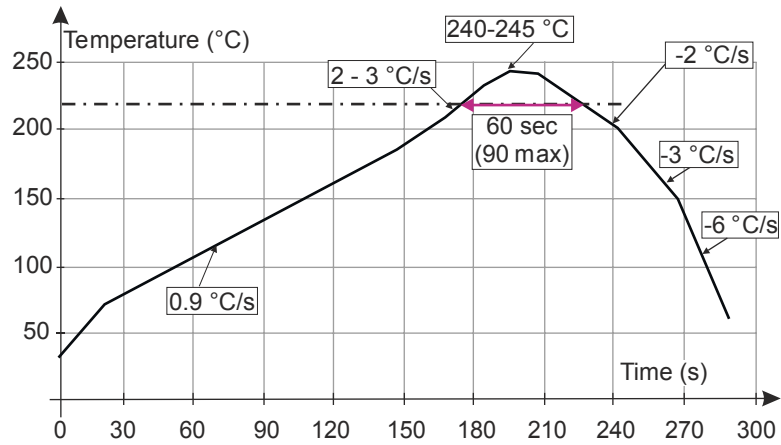

Note: Minimize air convection currents in the reflow oven to avoid component movement. Maximum soldering profile corresponds to the latest IPC/JEDEC J-STD-020.

For wave soldering profile refer to AN5088 chapter 1.5.

- [AN5088](#): Rectifiers thermal management, handling and mounting recommendations.

3 Ordering information

Table 5. Ordering information

| Order code | Marking | Package | Weight | Base qty. | Delivery mode |
|-------------------------------|---|---------|--------|-----------|---------------|
| P6KExxARL/CARL ⁽¹⁾ | Equal to order code (without RL suffix) | DO-15 | 0.4 g | 6000 | Reel |
| P6KExxA/CA | Equal to order code | | | 1000 | Ammopack |

1. Where xx is nominal value of V_{BR} and A or CA indicates unidirectional or bidirectional version.

Revision history

Table 6. Document revision history

| Date | Revision | Changes |
|-------------|----------|--|
| Feb-2003 | 4A | Last update |
| Oct-2004 | 5 | 1/ Note 5, <i>figure 7</i> on page 4, updated from $V_{BR} > 220\text{ V}$ to $V_{BR} \geq 200\text{ V}$. 2/ Types table on page 2: I_{PP} (@10/1000 μs) changed for P6KE220xx to P6KE440xx. |
| 14-Sep-2011 | 6 | Updated I_{RM} @ V_{RM} values, V_{BRmax} @ I_R for P6KE33 and order codes in <i>Table 3</i> . Updated footnotes to <i>Table 5</i> . Updated T_L temperature in <i>Table 1</i> . |
| 26-Apr-2012 | 7 | Corrected typographical area <i>Table 3</i> . |
| 29-Nov-2022 | 8 | Updated <i>Package information</i> . Minor text changes. |
| 10-Dec-2024 | 9 | Updated <i>Features</i> , <i>Figure 3</i> , <i>Figure 9</i> , and <i>Figure 16</i> . |

IMPORTANT NOTICE – READ CAREFULLY

STMicroelectronics NV and its subsidiaries (“ST”) reserve the right to make changes, corrections, enhancements, modifications, and improvements to ST products and/or to this document at any time without notice. Purchasers should obtain the latest relevant information on ST products before placing orders. ST products are sold pursuant to ST’s terms and conditions of sale in place at the time of order acknowledgment.

Purchasers are solely responsible for the choice, selection, and use of ST products and ST assumes no liability for application assistance or the design of purchasers’ products.

No license, express or implied, to any intellectual property right is granted by ST herein.

Resale of ST products with provisions different from the information set forth herein shall void any warranty granted by ST for such product.

ST and the ST logo are trademarks of ST. For additional information about ST trademarks, refer to www.st.com/trademarks. All other product or service names are the property of their respective owners.

Information in this document supersedes and replaces information previously supplied in any prior versions of this document.

© 2024 STMicroelectronics – All rights reserved