

Silicon carbide Power MOSFET 1200 V, 40 mΩ typ., 40 A in an HiP247-4 package

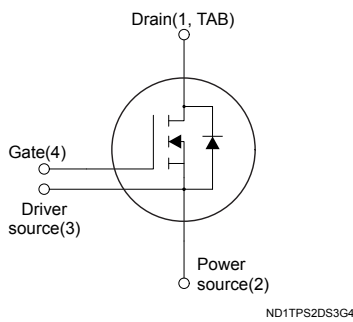
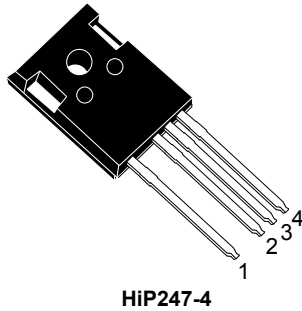

Product status link

[SCT040W120G3-4](#)

Product summary

| | |
|-------------------|----------------|
| Order code | SCT040W120G3-4 |
| Marking | SCT40W120G34 |
| Package | HiP247-4 |
| Packing | Tube |

Features

| Order code | V _{DS} | R _{DS(on)} typ. | I _D |
|----------------|-----------------|--------------------------|----------------|
| SCT040W120G3-4 | 1200 V | 40 mΩ | 40 A |

- Very fast and robust intrinsic body diode
- Very low R_{DS(on)} over the entire temperature range
- High speed switching performances
- Very high operating junction temperature capability (T_J = 200 °C)

Applications

- [Switching mode power supply](#)
- [Power supply for renewable energy systems](#)
- [DC-DC converters](#)

Description

This silicon carbide Power MOSFET device has been developed using ST's advanced and innovative 3rd generation SiC MOSFET technology. The device features a very low R_{DS(on)} over the entire temperature range combined with low capacitances and very high switching operations, which improve application performance in frequency, energy efficiency, system size and weight reduction.

1 Electrical ratings

Table 1. Absolute maximum ratings

| Symbol | Parameter | Value | Unit |
|----------------|--|------------|------------------|
| V_{DS} | Drain-source voltage | 1200 | V |
| V_{GS} | Gate-source voltage | -10 to 22 | V |
| | Gate-source voltage (recommended operating values) | -5 to 18 | |
| | Gate-source transient voltage, $t_p < 1 \mu s$, $t \leq 10$ hours over lifetime | -11 to 25 | |
| $I_D^{(1)}$ | Drain current (continuous) at $T_C = 25 \text{ }^\circ\text{C}$ | 40 | A |
| | Drain current (continuous) at $T_C = 100 \text{ }^\circ\text{C}$ | 40 | |
| $I_{DM}^{(2)}$ | Drain current (pulsed) | 179 | A |
| P_{TOT} | Total power dissipation at $T_C = 25 \text{ }^\circ\text{C}$ | 312 | W |
| T_{stg} | Storage temperature range | -55 to 200 | $^\circ\text{C}$ |
| T_J | Operating junction temperature range | | $^\circ\text{C}$ |

- I_D is limited by package.
- Pulse width is limited by safe operating area.

Table 2. Thermal data

| Symbol | Parameter | Value | Unit |
|------------|---|-------|---------------------------|
| R_{thJC} | Thermal resistance, junction-to-case | 0.56 | $^\circ\text{C}/\text{W}$ |
| R_{thJA} | Thermal resistance, junction-to-ambient | 40 | $^\circ\text{C}/\text{W}$ |

2 Electrical characteristics

$T_C = 25\text{ °C}$ unless otherwise specified.

Table 3. On/off states

| Symbol | Parameter | Test conditions | Min. | Typ. | Max. | Unit |
|---------------|-----------------------------------|--|------|------|-----------|---------------|
| $V_{(BR)DSS}$ | Drain-source breakdown voltage | $V_{GS} = 0\text{ V}$, $I_D = 1\text{ mA}$ | 1200 | | | V |
| I_{DSS} | Zero gate voltage drain current | $V_{GS} = 0\text{ V}$, $V_{DS} = 1200\text{ V}$ | | | 10 | μA |
| I_{GSS} | Gate-body leakage current | $V_{DS} = 0\text{ V}$, $V_{GS} = -10\text{ to }22\text{ V}$ | | | ± 100 | nA |
| $V_{GS(th)}$ | Gate threshold voltage | $V_{DS} = V_{GS}$, $I_D = 5\text{ mA}$ | 1.8 | 3.1 | 4.2 | V |
| $R_{DS(on)}$ | Static drain-source on-resistance | $V_{GS} = 15\text{ V}$, $I_D = 16\text{ A}$ | | 49 | | m Ω |
| | | $V_{GS} = 18\text{ V}$, $I_D = 16\text{ A}$ | | 40 | 54 | |
| | | $V_{GS} = 18\text{ V}$, $I_D = 16\text{ A}$, $T_J = 200\text{ °C}$ | | 77 | | |

Table 4. Dynamic

| Symbol | Parameter | Test conditions | Min. | Typ. | Max. | Unit |
|------------|------------------------------|---|------|------|------|----------|
| C_{iss} | Input capacitance | $V_{DS} = 800\text{ V}$, $f = 1\text{ MHz}$, $V_{GS} = 0\text{ V}$ | - | 1329 | - | pF |
| C_{oss} | Output capacitance | | - | 78 | - | pF |
| C_{riss} | Reverse transfer capacitance | | - | 10 | - | pF |
| Q_g | Total gate charge | $V_{DD} = 800\text{ V}$, $V_{GS} = -5\text{ to }18\text{ V}$, $I_D = 16\text{ A}$ | - | 56 | - | nC |
| Q_{gs} | Gate-source charge | | - | 17 | - | nC |
| Q_{gd} | Gate-drain charge | | - | 19 | - | nC |
| R_g | Gate input resistance | $f = 1\text{ MHz}$, $I_D = 0\text{ A}$ | - | 1.4 | - | Ω |

Table 5. Switching energy (inductive load)

| Symbol | Parameter | Test conditions | Min. | Typ. | Max. | Unit |
|-----------|---------------------------|--|------|------|------|---------------|
| E_{on} | Turn-on switching energy | $V_{DD} = 800\text{ V}$, $I_D = 16\text{ A}$, | - | 273 | - | μJ |
| E_{off} | Turn-off switching energy | $R_G = 12\text{ }\Omega$, $V_{GS} = -5\text{ V to }18\text{ V}$ | - | 100 | - | μJ |

Table 6. Switching times

| Symbol | Parameter | Test conditions | Min. | Typ. | Max. | Unit |
|--------------|---------------------|---|------|------|------|------|
| $t_{d(on)}$ | Turn-on delay time | $V_{DD} = 800\text{ V}$, $I_D = 16\text{ A}$, $R_G = 12\text{ }\Omega$, $V_{GS} = -5\text{ to }18\text{ V}$ | - | 12 | - | ns |
| t_r | Rise time | | - | 6 | - | ns |
| $t_{d(off)}$ | Turn-off delay time | | - | 34 | - | ns |
| t_f | Fall time | | - | 22 | - | ns |

Table 7. Reverse SiC diode characteristics

| Symbol | Parameter | Test conditions | Min. | Typ. | Max. | Unit |
|----------------|----------------------------------|---|------|------|------|------|
| $I_{SD}^{(1)}$ | Continuous diode forward current | $T_C = 25\text{ }^\circ\text{C}$ | - | | 40 | A |
| | | $T_C = 100\text{ }^\circ\text{C}$ | - | | 40 | |
| V_{SD} | Diode forward voltage | $I_{SD} = 16\text{ A}$, $V_{GS} = 0\text{ V}$ | - | 2.6 | | V |
| t_{rr} | Reverse recovery time | $I_{SD} = 16\text{ A}$, $di/dt = 1000\text{ A}/\mu\text{s}$, $V_{DD} = 800\text{ V}$ | - | 16 | | ns |
| Q_{rr} | Reverse recovery charge | | - | 100 | | nC |
| I_{RRM} | Reverse recovery current | | - | 11 | | A |

1. I_{SD} is limited by package.

2.1 Electrical characteristics (curves)

Figure 1. Safe operating area

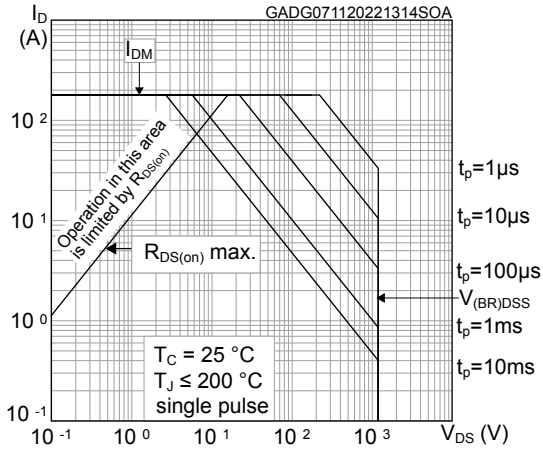

Figure 2. Maximum transient thermal impedance

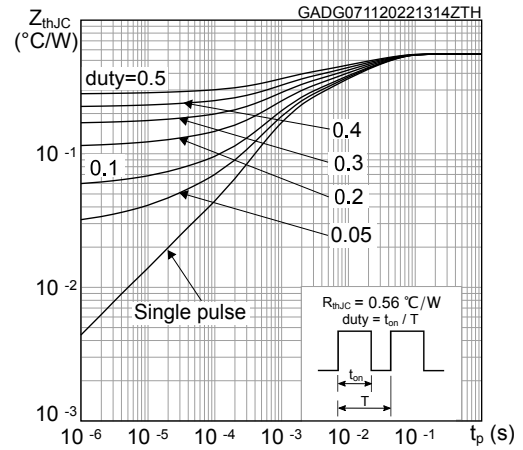

Figure 3. Typical output characteristics ($T_J = 25\text{ °C}$)

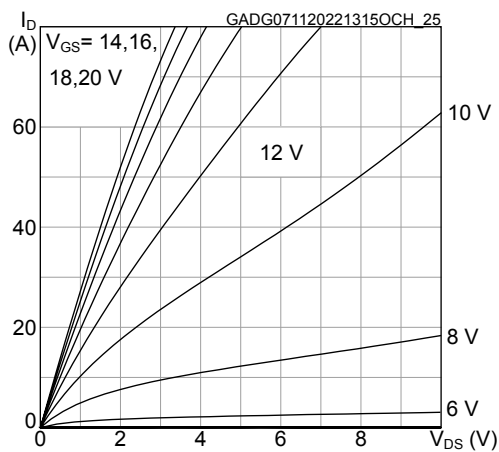

Figure 4. Typical output characteristics ($T_J = 200\text{ °C}$)

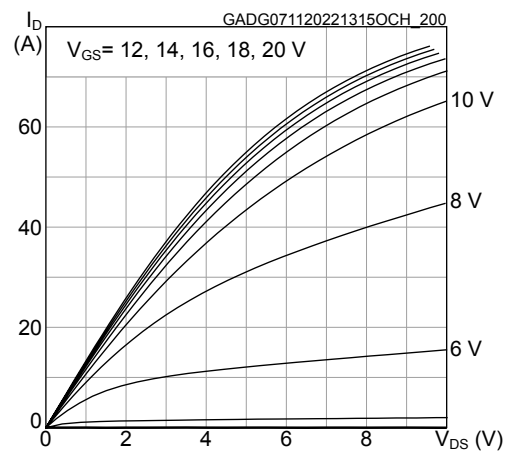

Figure 5. Typical transfer characteristics

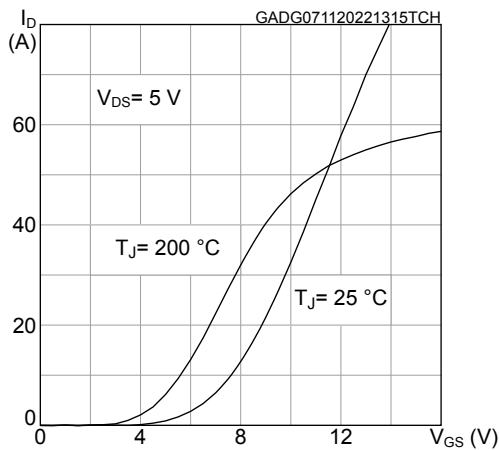

Figure 6. Total power dissipation

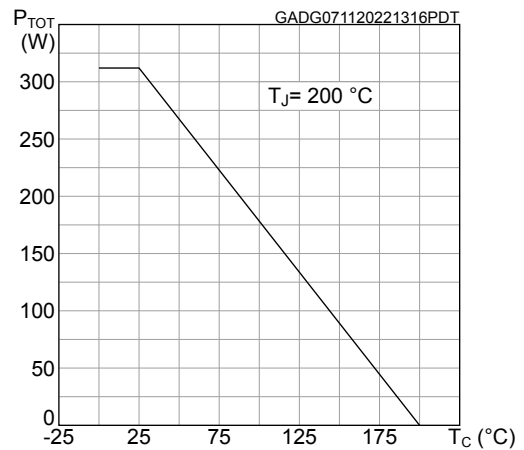

Figure 7. Typical gate charge characteristics

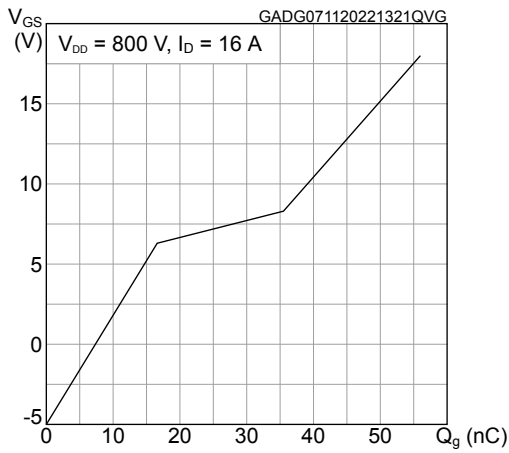

Figure 8. Typical capacitance characteristics

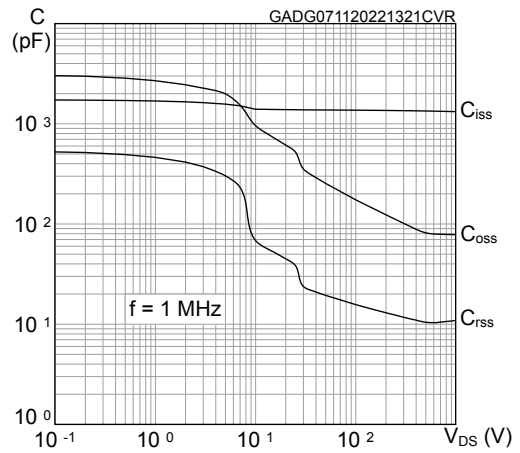

Figure 9. Typical switching energy vs supply voltage

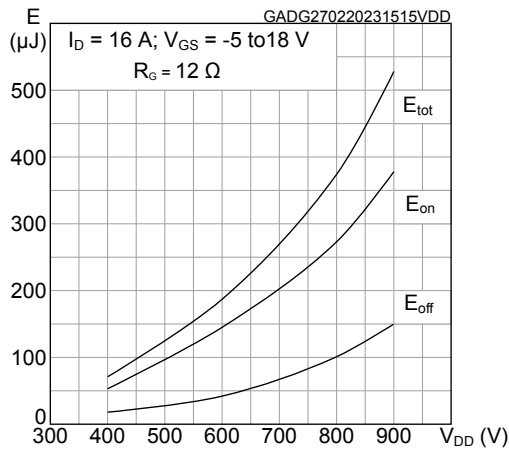

Figure 10. Typical switching energy vs drain current

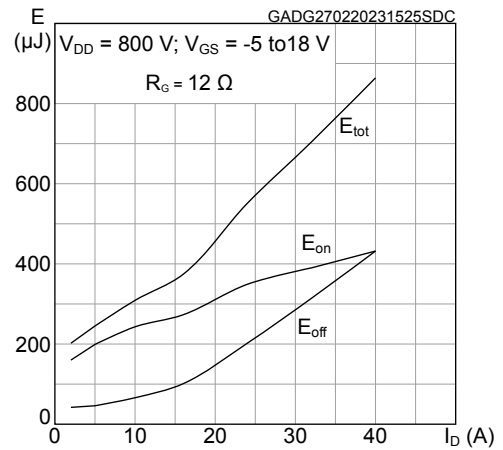

Figure 11. Typical switching energy vs gate resistance

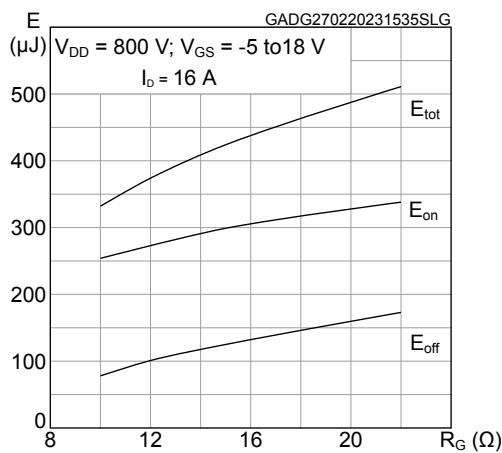

Figure 12. Typical switching energy vs temperature

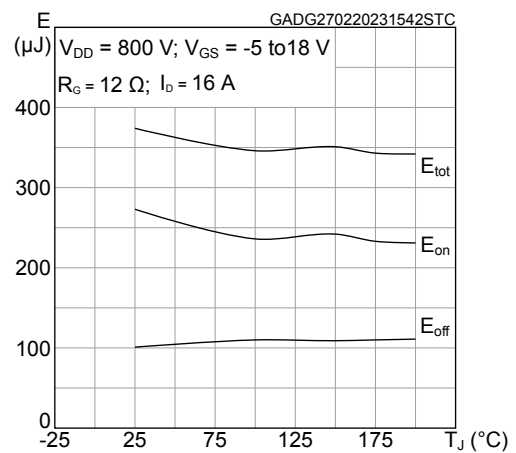

Figure 13. Normalized breakdown voltage vs temperature

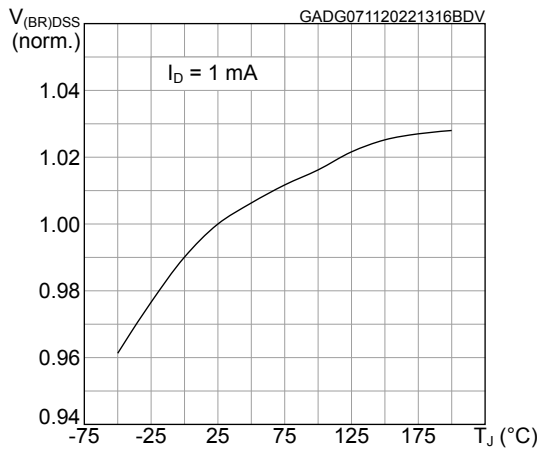

Figure 14. Normalized gate threshold vs temperature

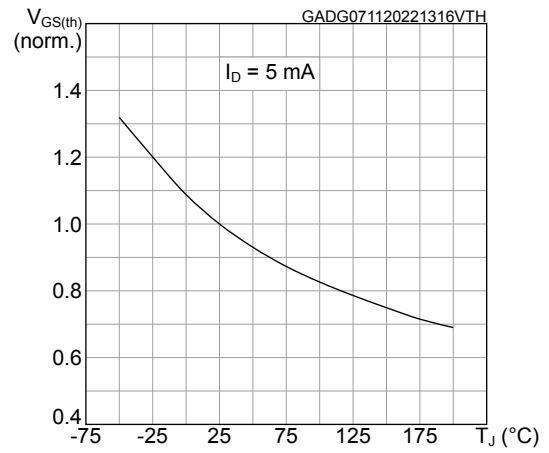

Figure 15. Normalized on-resistance vs temperature

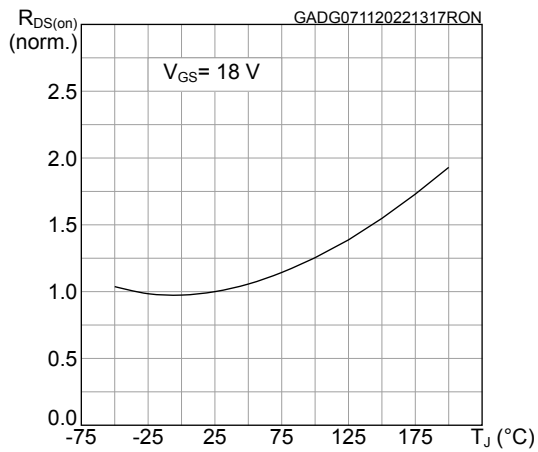

Figure 16. Typical reverse conduction characteristics (T_J = 25 °C)

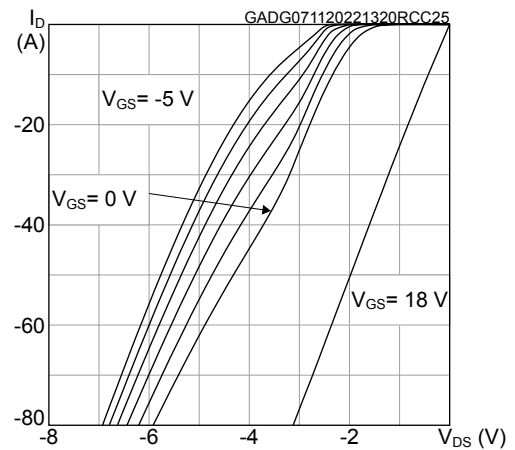
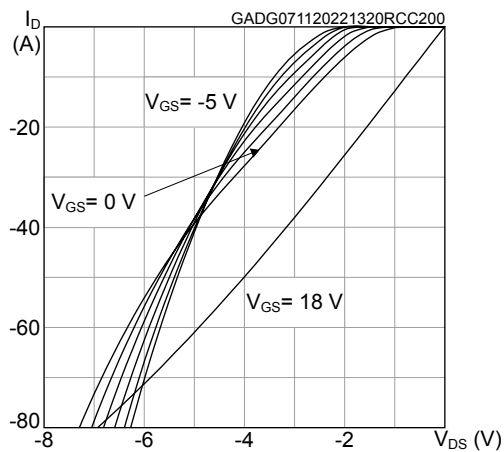

Figure 17. Typical reverse conduction characteristics (T_J = 200 °C)



3 Package information

In order to meet environmental requirements, ST offers these devices in different grades of **ECOPACK** packages, depending on their level of environmental compliance. ECOPACK specifications, grade definitions and product status are available at: www.st.com. ECOPACK is an ST trademark.

3.1 HiP247-4 package information

Figure 18. HiP247-4 package outline

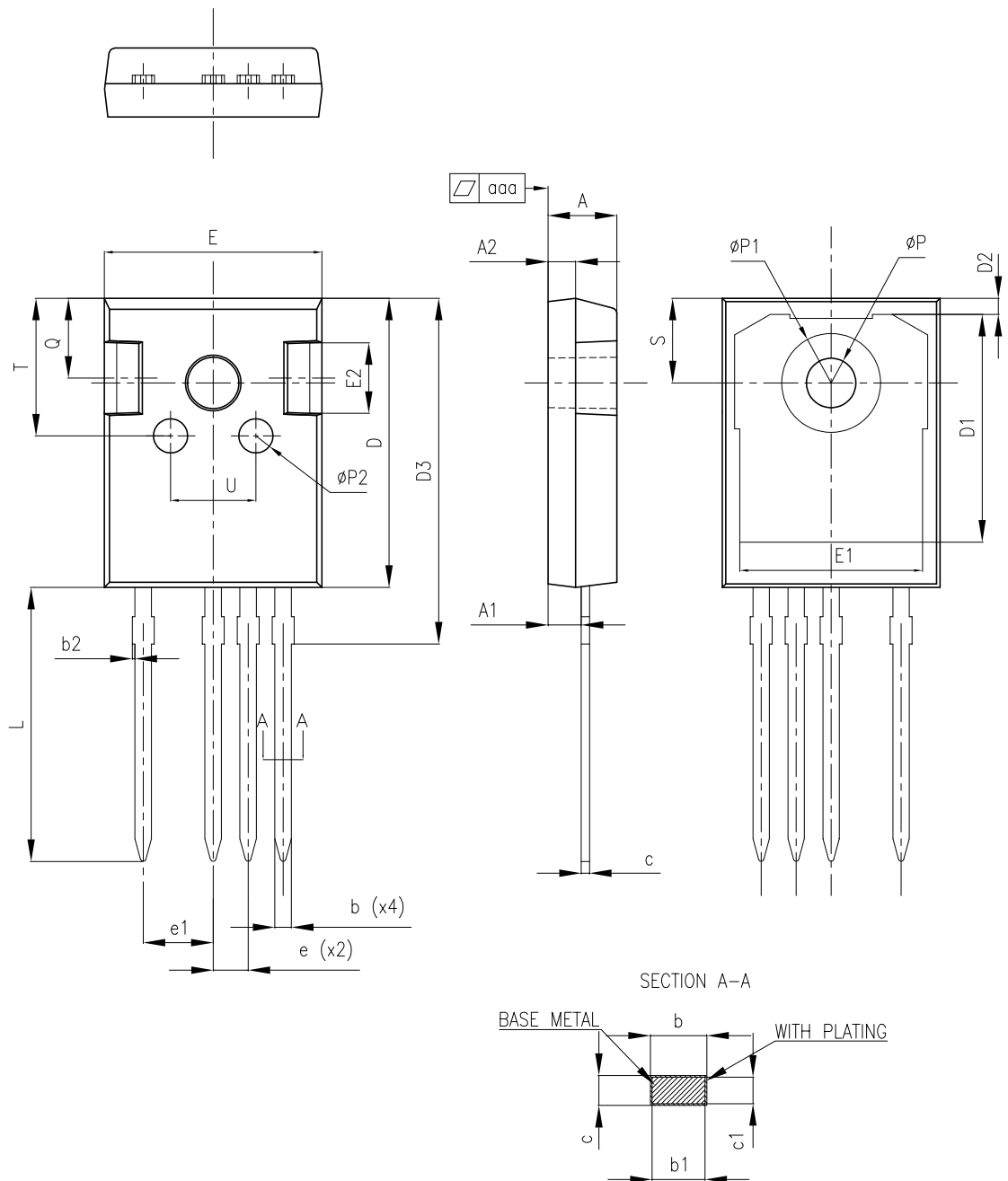

Table 8. HiP247-4 mechanical data

| Dim. | mm | | |
|------|-------|-------|-------|
| | Min. | Typ. | Max. |
| A | 4.90 | 5.00 | 5.10 |
| A1 | 2.31 | 2.41 | 2.51 |
| A2 | 1.90 | 2.00 | 2.10 |
| b | 1.16 | | 1.29 |
| b1 | 1.15 | 1.20 | 1.25 |
| b2 | 0 | | 0.20 |
| c | 0.59 | | 0.66 |
| c1 | 0.58 | 0.60 | 0.62 |
| D | 20.90 | 21.00 | 21.10 |
| D1 | 16.25 | 16.55 | 16.85 |
| D2 | 1.05 | 1.20 | 1.35 |
| D3 | 24.97 | 25.12 | 25.27 |
| E | 15.70 | 15.80 | 15.90 |
| E1 | 13.10 | 13.30 | 13.50 |
| E2 | 4.90 | 5.00 | 5.10 |
| E3 | 2.40 | 2.50 | 2.60 |
| e | 2.44 | 2.54 | 2.64 |
| e1 | 4.98 | 5.08 | 5.18 |
| L | 19.80 | 19.92 | 20.10 |
| P | 3.50 | 3.60 | 3.70 |
| P1 | | | 7.40 |
| P2 | 2.40 | 2.50 | 2.60 |
| Q | 5.60 | | 6.00 |
| S | | 6.15 | |
| T | 9.80 | | 10.20 |
| U | 6.00 | | 6.40 |
| aaa | | 0.04 | 0.10 |

Revision history

Table 9. Document revision history

| Date | Revision | Changes |
|-------------|----------|----------------|
| 10-Aug-2023 | 1 | First release. |

Contents

| | | |
|------------|--|-----------|
| 1 | Electrical ratings | 2 |
| 2 | Electrical characteristics | 3 |
| 2.1 | Electrical characteristics (curves) | 5 |
| 3 | Package information | 8 |
| 3.1 | HiP247-4 package information | 8 |
| | Revision history | 10 |

IMPORTANT NOTICE – READ CAREFULLY

STMicroelectronics NV and its subsidiaries (“ST”) reserve the right to make changes, corrections, enhancements, modifications, and improvements to ST products and/or to this document at any time without notice. Purchasers should obtain the latest relevant information on ST products before placing orders. ST products are sold pursuant to ST’s terms and conditions of sale in place at the time of order acknowledgment.

Purchasers are solely responsible for the choice, selection, and use of ST products and ST assumes no liability for application assistance or the design of purchasers’ products.

No license, express or implied, to any intellectual property right is granted by ST herein.

Resale of ST products with provisions different from the information set forth herein shall void any warranty granted by ST for such product.

ST and the ST logo are trademarks of ST. For additional information about ST trademarks, refer to www.st.com/trademarks. All other product or service names are the property of their respective owners.

Information in this document supersedes and replaces information previously supplied in any prior versions of this document.

© 2023 STMicroelectronics – All rights reserved