

Silicon carbide Power MOSFET 1700 V, 43 A, 64 mΩ (typ., T_J = 25 °C) in an HiP247 package

HiP247

AM01475v1_noZen

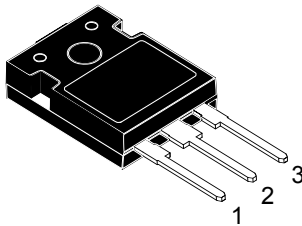
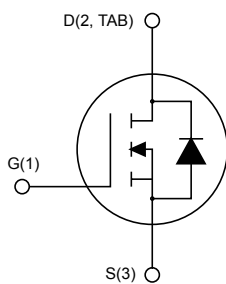

Features

Order code	V _{DS}	R _{DS(on)} typ.	I _D
SCT20N170	1700 V	64 mΩ	43 A

- High speed switching performance
- Very fast and robust intrinsic body diode
- Low capacitances
- Very high operating junction temperature capability (T_J = 200 °C)

Applications

- Solar inverters, UPS
- Motor drives
- Down hole drilling
- Windmills

Description

This silicon carbide Power MOSFET is produced exploiting the advanced, innovative properties of wide bandgap materials. This results in unsurpassed on-resistance per unit area and very good switching performance almost independent of temperature. The outstanding thermal properties of the SiC material, combined with the device's housing in the proprietary HiP247 package, allows designers to use an industry standard outline with significantly improved thermal capability. These features render the device perfectly suitable for high-efficiency and high power density applications.

Product status link

[SCT20N170](#)

Product summary

Order code	SCT20N170
Marking	SCT20N170
Package	HiP247
Packing	Tube

1 Electrical ratings

Table 1. Absolute maximum ratings

Symbol	Parameter	Value	Unit
V_{DS}	Drain-source voltage	1700	V
V_{GS}	Gate-source voltage	-10 to 22	V
I_D	Drain current (continuous) at $T_C = 25\text{ °C}$	43	A
	Drain current (continuous) at $T_C = 100\text{ °C}$	32	
$I_{DM}^{(1)}$	Drain current (pulsed)	129	A
P_{TOT}	Total power dissipation at $T_C = 25\text{ °C}$	313	W
T_{stg}	Storage temperature range	-55 to 200	°C
T_J	Operating junction temperature range		°C

1. Pulse width is limited by safe operating area.

Table 2. Thermal data

Symbol	Parameter	Value	Unit
$R_{thj-case}$	Thermal resistance junction-case	0.56	°C/W
$R_{thj-amb}$	Thermal resistance junction-ambient	40	°C/W

2 Electrical characteristics

($T_C = 25\text{ °C}$ unless otherwise specified)

Table 3. On/off states

Symbol	Parameter	Test conditions	Min.	Typ.	Max.	Unit
$V_{(BR)DSS}$	Drain-source breakdown voltage	$V_{GS} = 0\text{ V}, I_D = 1\text{ mA}$	1700			V
I_{DSS}	Zero gate voltage drain current	$V_{GS} = 0\text{ V}, V_{DS} = 1700\text{ V}$			10	μA
I_{GSS}	Gate-body leakage current	$V_{DS} = 0\text{ V}, V_{GS} = -10\text{ V to } 22\text{ V}$			± 100	nA
$V_{GS(th)}$	Gate threshold voltage	$V_{DS} = V_{GS}, I_D = 1\text{ mA}$	1.8	3		V
$R_{DS(on)}$	Static drain-source on-resistance	$V_{GS} = 20\text{ V}, I_D = 20\text{ A}$		64	86	m Ω
		$V_{GS} = 20\text{ V}, I_D = 20\text{ A}, T_J = 150\text{ °C}$		104		
		$V_{GS} = 20\text{ V}, I_D = 20\text{ A}, T_J = 200\text{ °C}$		134		

Table 4. Dynamic

Symbol	Parameter	Test conditions	Min.	Typ.	Max.	Unit
C_{iss}	Input capacitance	$V_{DS} = 400\text{ V}, f = 1\text{ MHz}, V_{GS} = 0\text{ V}$	-	1568	-	pF
C_{oss}	Output capacitance		-	141	-	pF
C_{rSS}	Reverse transfer capacitance		-	21	-	pF
R_g	Gate input resistance	$f = 1\text{ MHz}, I_D = 0\text{ A}$	-	6.9	-	Ω
Q_g	Total gate charge	$V_{DS} = 1000\text{ V}, I_D = 25\text{ A}, V_{GS} = -5\text{ to } 20\text{ V}$	-	101	-	nC
Q_{gs}	Gate-source charge		-	48	-	nC
Q_{gd}	Gate-drain charge		-	23	-	nC

Table 5. Switching energy (inductive load)

Symbol	Parameter	Test conditions	Min.	Typ.	Max.	Unit
E_{on}	Turn-on switching energy	$V_{DD} = 1000\text{ V}, I_D = 25\text{ A}$	-	623	-	μJ
E_{off}	Turn-off switching energy	$R_G = 4.7\ \Omega, V_{GS} = 0\text{ V to } 20\text{ V}$	-	180	-	μJ
E_{on}	Turn-on switching energy	$V_{DD} = 1000\text{ V}, I_D = 25\text{ A}, R_G = 4.7\ \Omega,$	-	1162	-	μJ
E_{off}	Turn-off switching energy	$V_{GS} = 0\text{ V to } 20\text{ V}, T_J = 200\text{ °C}$	-	183	-	μJ

Table 6. Reverse SiC diode characteristics

Symbol	Parameter	Test conditions	Min.	Typ.	Max.	Unit
V_{SD}	Diode forward voltage	$I_F = 25\text{ A}$, $V_{GS} = 0\text{ V}$	-	3.8	-	V
t_{rr}	Reverse recovery time	$I_{SD} = 25\text{ A}$, $V_{GS} = 0\text{ V}$, $di/dt = 100\text{ A}/\mu\text{s}$, $V_{DD} = 1000\text{ V}$	-	13	-	ns
Q_{rr}	Reverse recovery charge		-	280	-	nC
I_{RRM}	Reverse recovery current		-	37	-	A

2.1 Electrical characteristics (curves)
Figure 1. Safe operating area

Figure 2. Maximum transient thermal impedance

Figure 3. Typical output characteristics ($T_J = 25\text{ }^\circ\text{C}$)

Figure 4. Typical output characteristics ($T_J = 200\text{ }^\circ\text{C}$)

Figure 5. Typical transfer characteristics

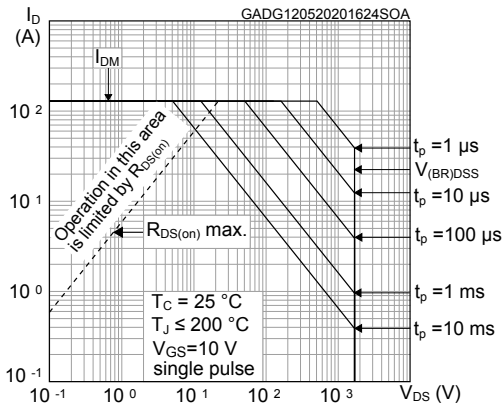
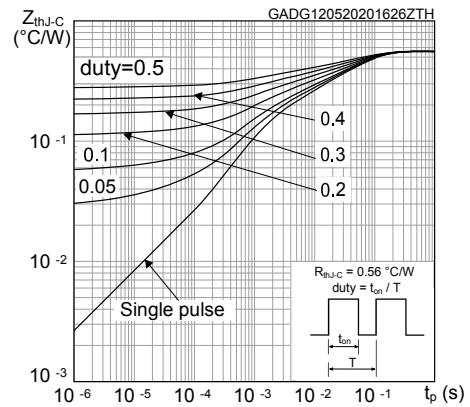
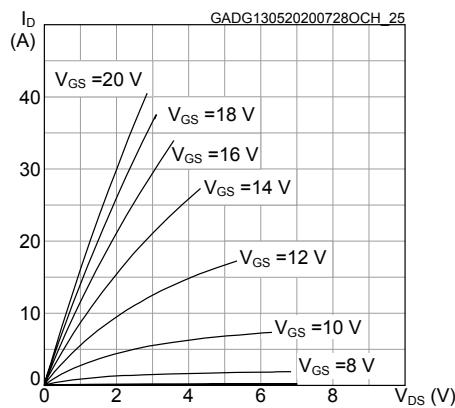
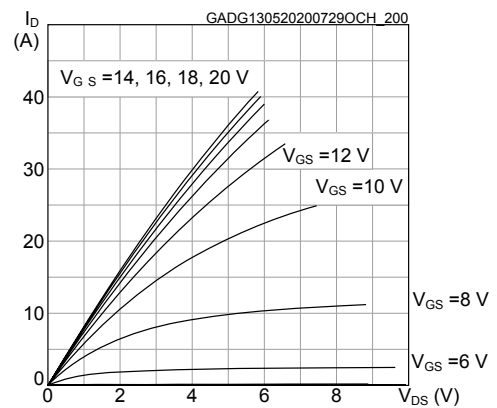
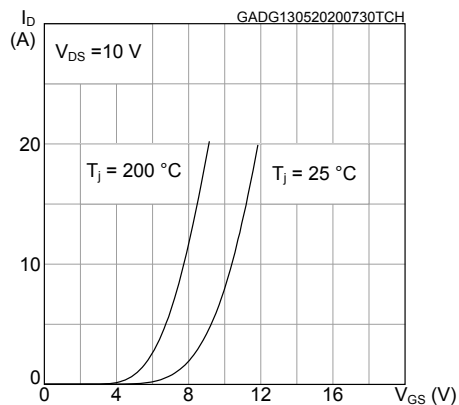
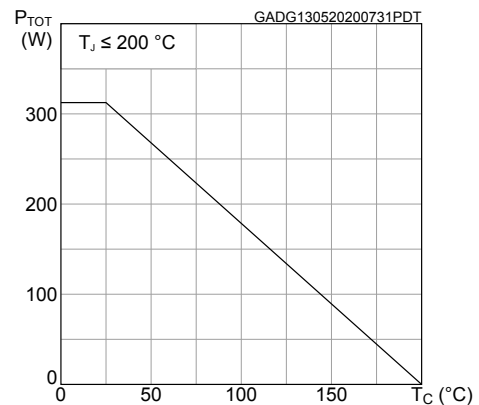
Figure 6. Total power dissipation

Figure 7. Typical gate charge characteristics

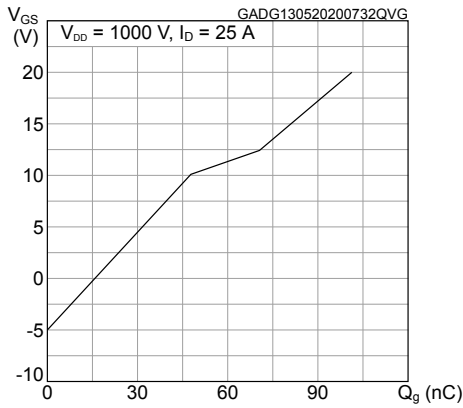

Figure 8. Typical capacitance characteristics

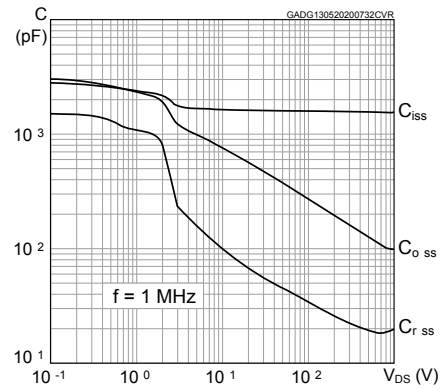

Figure 9. Typical switching energy vs I_D

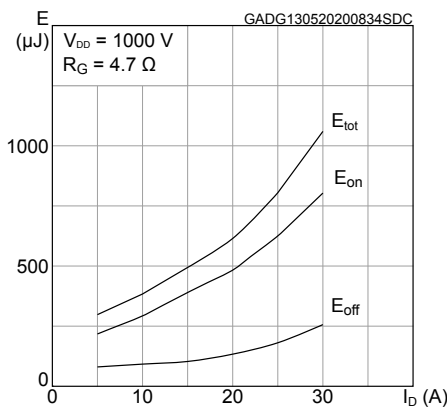

Figure 10. Typical switching energy vs temperature

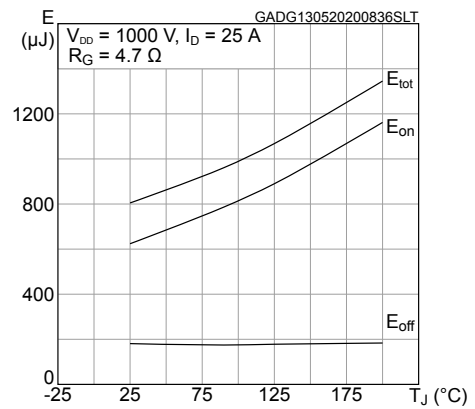

Figure 11. Typical switching energy vs R_G

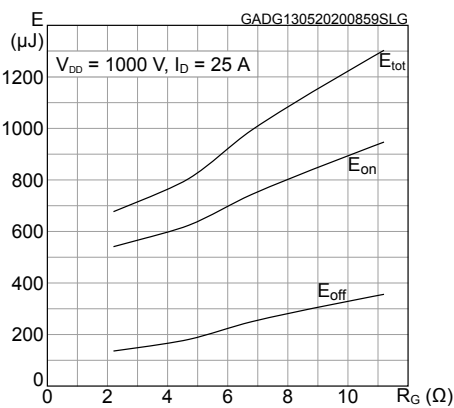

Figure 12. Typical drain-source on-resistance

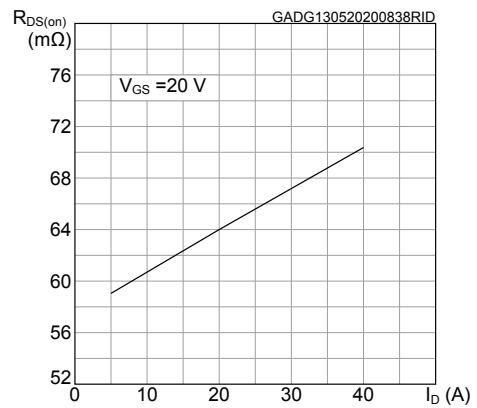

Figure 13. Normalized breakdown voltage vs temperature

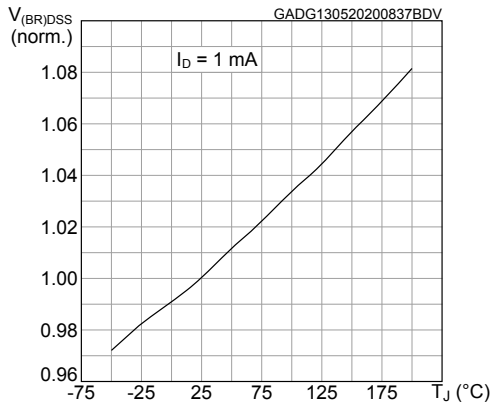

Figure 14. Normalized gate threshold vs temperature

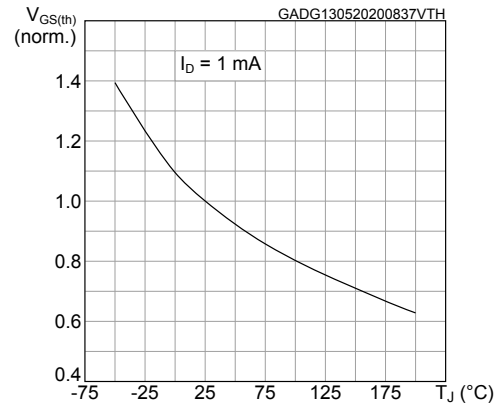

Figure 15. Normalized on-resistance vs temperature

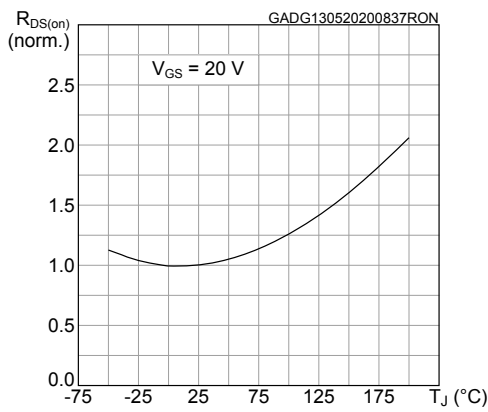

Figure 16. Typical reverse conduction characteristics ($T_J = 25^\circ\text{C}$)

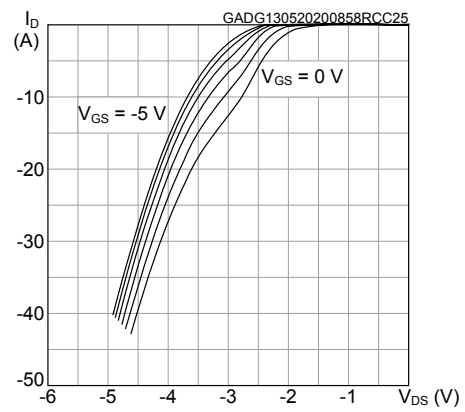
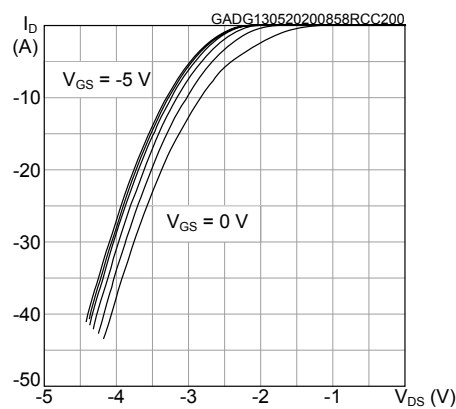

Figure 17. Typical reverse conduction characteristics ($T_J = 200^\circ\text{C}$)



3 Package information

In order to meet environmental requirements, ST offers these devices in different grades of **ECOPACK** packages, depending on their level of environmental compliance. ECOPACK specifications, grade definitions and product status are available at: www.st.com. ECOPACK is an ST trademark.

3.1 HiP247 package information

Figure 18. HiP247 package outline

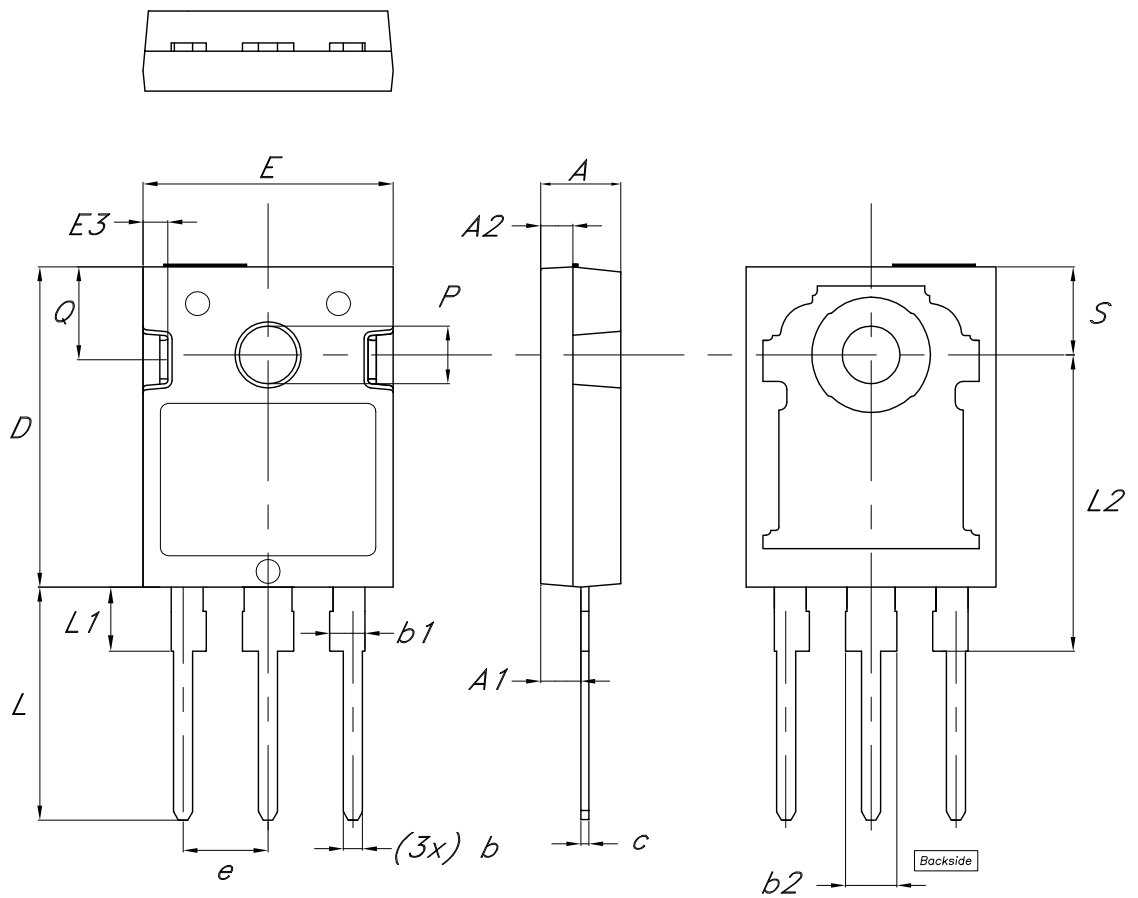

8581091_3_fig2

Table 7. HiP247 package mechanical data

Dim.	mm		
	Min.	Typ.	Max.
A	4.85	5.00	5.15
A1	2.20		2.60
A2	1.90	2.00	2.10
b	1.00		1.40
b1	2.00		2.40
b2	3.00		3.40
c	0.40		0.80
D	19.85	20.00	20.15
E	15.45	15.60	15.75
E3	1.45		1.65
e	5.30	5.45	5.60
L	14.20		14.80
L1	3.70		4.30
L2	18.30	18.50	18.70
P	3.55		3.65
Q	5.65		5.95
S	5.30	5.50	5.70

Revision history

Table 8. Document revision history

Date	Revision	Changes
23-Jul-2020	1	First release.

Contents

1	Electrical ratings	2
2	Electrical characteristics	3
2.1	Electrical characteristics (curves)	5
3	Package information	8
3.1	HiP247 package information	8
	Revision history	10

IMPORTANT NOTICE – PLEASE READ CAREFULLY

STMicroelectronics NV and its subsidiaries (“ST”) reserve the right to make changes, corrections, enhancements, modifications, and improvements to ST products and/or to this document at any time without notice. Purchasers should obtain the latest relevant information on ST products before placing orders. ST products are sold pursuant to ST’s terms and conditions of sale in place at the time of order acknowledgement.

Purchasers are solely responsible for the choice, selection, and use of ST products and ST assumes no liability for application assistance or the design of Purchasers’ products.

No license, express or implied, to any intellectual property right is granted by ST herein.

Resale of ST products with provisions different from the information set forth herein shall void any warranty granted by ST for such product.

ST and the ST logo are trademarks of ST. For additional information about ST trademarks, please refer to www.st.com/trademarks. All other product or service names are the property of their respective owners.

Information in this document supersedes and replaces information previously supplied in any prior versions of this document.

© 2020 STMicroelectronics – All rights reserved