

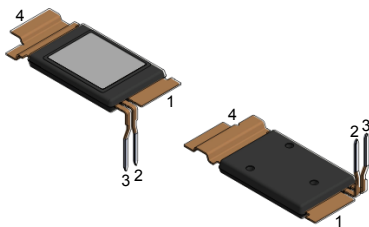
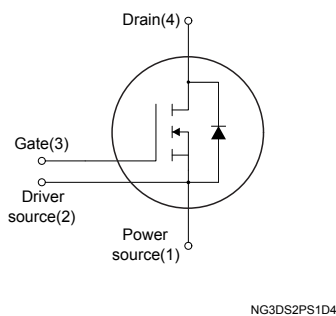

Automotive-grade silicon carbide Power MOSFET 1200 V, 9.3 mΩ typ., 170 A in a STPAK package

STPAK

Features

Order code	V _{DS}	R _{DS(on)} typ.	I _D
SCTHS200N120G3AG	1200 V	9.3 mΩ	170 A

- AEC-Q101 qualified 
- Very low R_{DS(on)} over the entire temperature range
- High speed switching performances
- Very fast and robust intrinsic body diode
- Source sensing pin for increased efficiency

Application

- Main inverter (electric traction)

Description

This silicon carbide Power MOSFET device has been developed using ST's advanced and innovative 3rd generation SiC MOSFET technology. The device features a very low R_{DS(on)} over the entire temperature range combined with low capacitances and very high switching operations, which improve application performance in frequency, energy efficiency, system size and weight reduction.

Product status link

[SCTHS200N120G3AG](#)

Product summary

Order code	SCTHS200N120G3AG
Marking	SCT200N120G3AG
Package	STPAK
Packing	Tray

1 Electrical ratings

Table 1. Absolute maximum ratings

Symbol	Parameter	Value	Unit
V _{GS}	Gate-source voltage	-10 to 22	V
	Gate-source voltage (recommended operating values)	-5 to 18	
I _D	Drain current (continuous) at T _C = 25 °C	170	A
	Drain current (continuous) at T _C = 100 °C	128	
I _{DM} ⁽¹⁾	Drain current (pulsed)	514	A
P _{TOT}	Total power dissipation at T _C = 25 °C	875	W
V _{ISO}	Insulation withstand voltage applied between each pin and the heat sink plate (DC voltage, t = 1 s)	4.3	kV
T _{stg}	Storage temperature range	-55 to 200	°C
T _J	Operating junction temperature range		

1. Pulse width is limited by safe operating area.

Table 2. Thermal data

Symbol	Parameter	Value	Unit
R _{thJC}	Thermal resistance, junction-to-case	0.20	°C/W

2 Electrical characteristics

$T_C = 25\text{ }^\circ\text{C}$ unless otherwise specified.

Table 3. On/off states

Symbol	Parameter	Test conditions	Min.	Typ.	Max.	Unit
$V_{(BR)DSS}$	Drain-source breakdown voltage	$V_{GS} = 0\text{ V}, I_D = 1\text{ mA}$	1300			V
I_{DSS}	Zero gate voltage drain current	$V_{GS} = 0\text{ V}, V_{DS} = 1200\text{ V}$		2	20	μA
I_{GSS}	Gate-body leakage current	$V_{DS} = 0\text{ V}, V_{GS} = -10\text{ to }22\text{ V}$			± 20	nA
$V_{GS(th)}$	Gate threshold voltage	$V_{DS} = V_{GS}, I_D = 4.6\text{ mA}$	1.8	3.0	4.2	V
$R_{DS(on)}$	Static drain-source on-resistance	$V_{GS} = 18\text{ V}, I_D = 100\text{ A}$		9.3	13	m Ω
		$V_{GS} = 18\text{ V}, I_D = 100\text{ A}, T_J = 175\text{ }^\circ\text{C}$		17.2		
		$V_{GS} = 18\text{ V}, I_D = 100\text{ A}, T_J = 200\text{ }^\circ\text{C}$		19.2		

Table 4. Dynamic

Symbol	Parameter	Test conditions	Min.	Typ.	Max.	Unit
C_{iss}	Input capacitance	$V_{DS} = 800\text{ V}, f = 1\text{ MHz}, V_{GS} = 0\text{ V}$	-	5991	-	pF
C_{oss}	Output capacitance		-	301	-	pF
C_{rss}	Reverse transfer capacitance		-	40	-	pF
R_g	Gate input resistance	$f = 1\text{ MHz}, I_D = 0\text{ A}$	-	6.8	-	Ω
Q_g	Total gate charge	$V_{DD} = 800\text{ V}, V_{GS} = -5\text{ to }18\text{ V}, I_D = 100\text{ A}$	-	253	-	nC
Q_{gs}	Gate-source charge		-	80	-	nC
Q_{gd}	Gate-drain charge		-	81	-	nC

Table 5. Switching energy (inductive load)

Symbol	Parameter	Test conditions	Min.	Typ.	Max.	Unit
E_{on}	Turn-on switching energy	$V_{DD} = 800\text{ V}, I_D = 100\text{ A},$	-	2506	-	μJ
E_{off}	Turn-off switching energy	$R_G = 6.8\text{ }\Omega, V_{GS} = -5\text{ V to }18\text{ V}$	-	1950	-	μJ

Table 6. Reverse SiC diode characteristics

Symbol	Parameter	Test conditions	Min.	Typ.	Max.	Unit
V_{SD}	Diode forward voltage	$I_{SD} = 100\text{ A}, V_{GS} = 0\text{ V}$	-	2.9	-	V
t_{rr}	Reverse recovery time	$I_{SD} = 100\text{ A}, di/dt = 1\text{ kA}/\mu\text{s},$ $V_{GS} = -5\text{ to }18\text{ V}, V_{DD} = 800\text{ V}$	-	36.4	-	ns
Q_{rr}	Reverse recovery charge		-	530.9	-	nC
I_{RRM}	Reverse recovery current		-	25.6	-	A

2.1 Electrical characteristics (curves)

Figure 1. Safe operating area

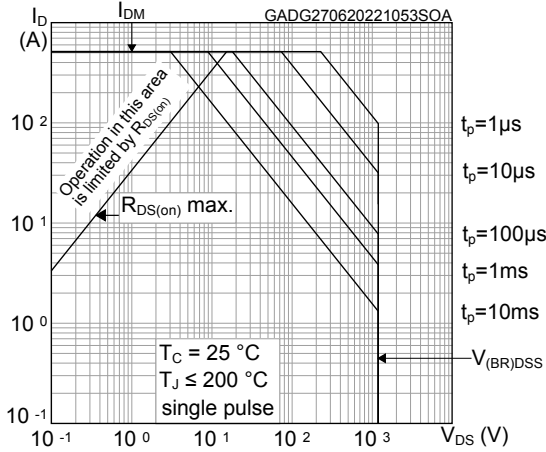

Figure 2. Maximum transient thermal impedance

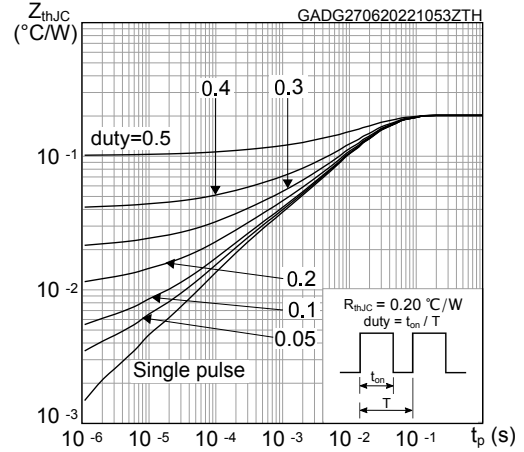

Figure 3. Typical output characteristics ($T_J = 25\text{ °C}$)

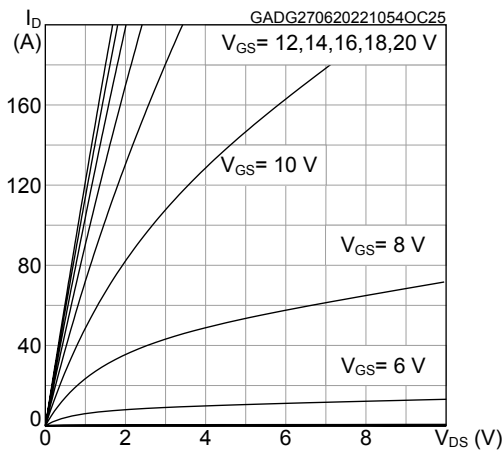

Figure 4. Typical output characteristics ($T_J = 200\text{ °C}$)

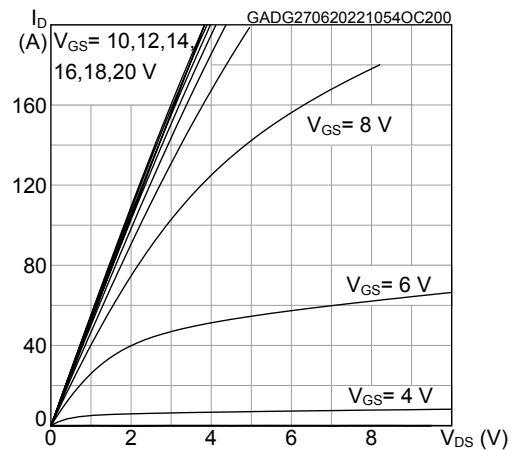

Figure 5. Typical transfer characteristics

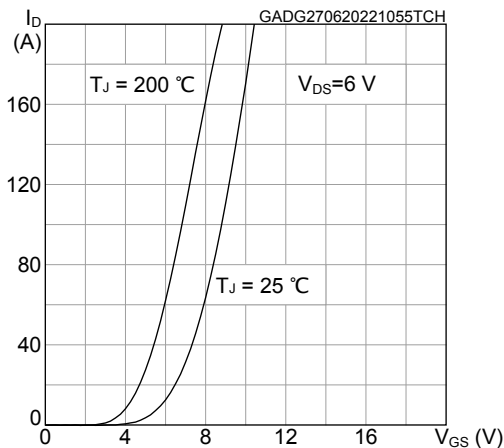
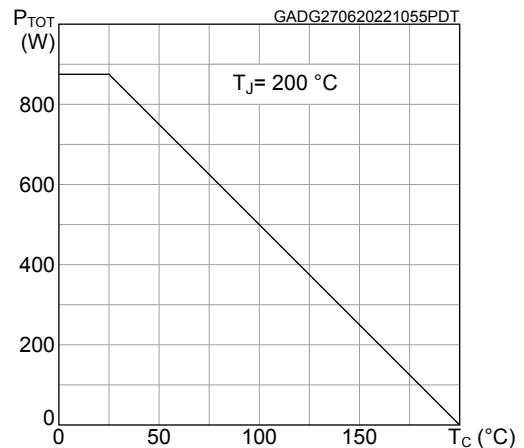

Figure 6. Total power dissipation



Prerelease product(s)

Figure 7. Typical gate charge characteristics

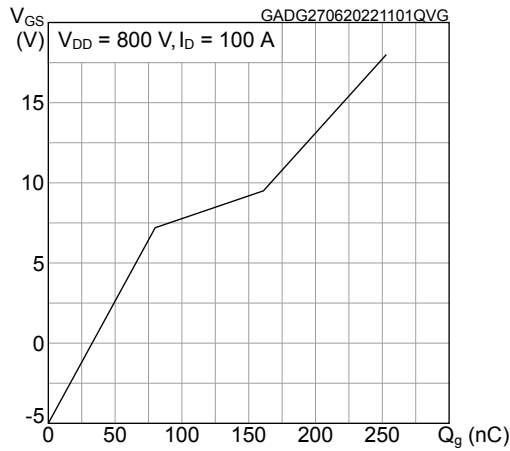

Figure 8. Typical capacitance characteristics

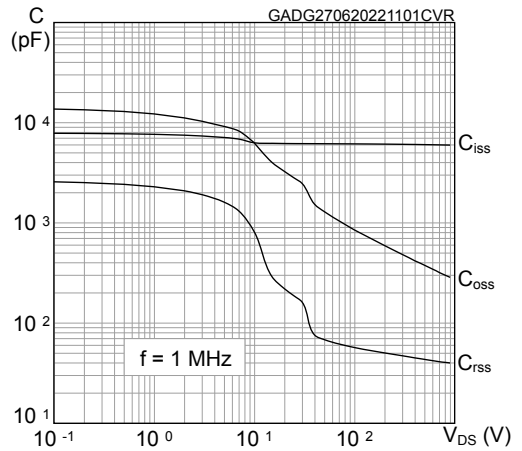

Figure 9. Typical switching energy vs drain current

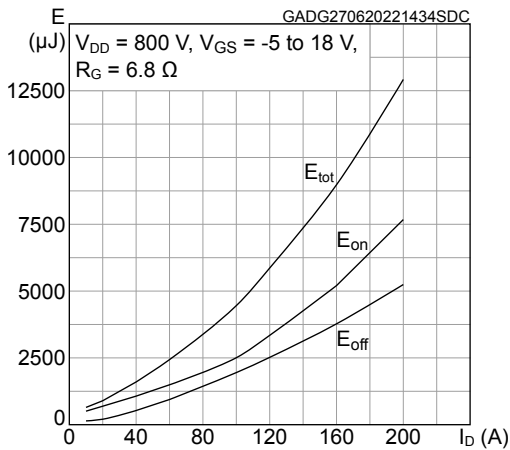

Figure 10. Typical switching energy vs gate resistance

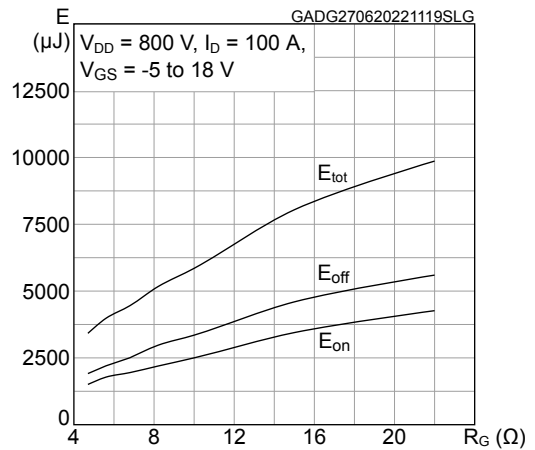

Figure 11. Switching energy vs. supply voltage

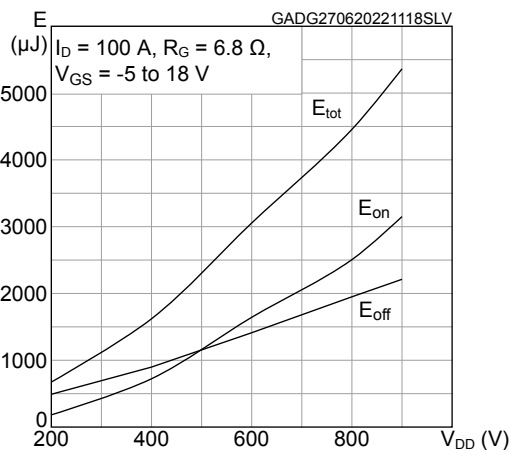
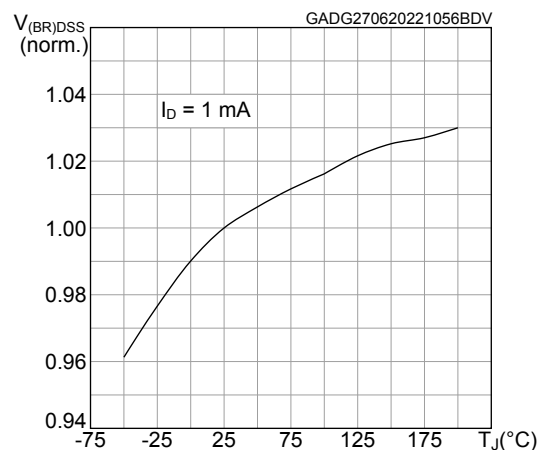

Figure 12. Normalized breakdown voltage vs temperature



Prerelease product(s)

Figure 13. Normalized gate threshold vs temperature

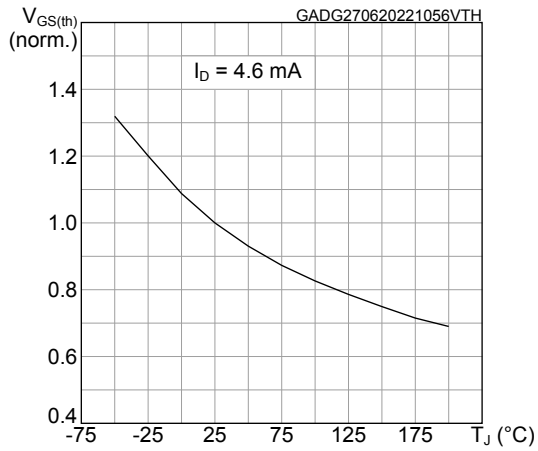

Figure 14. Normalized on-resistance vs temperature

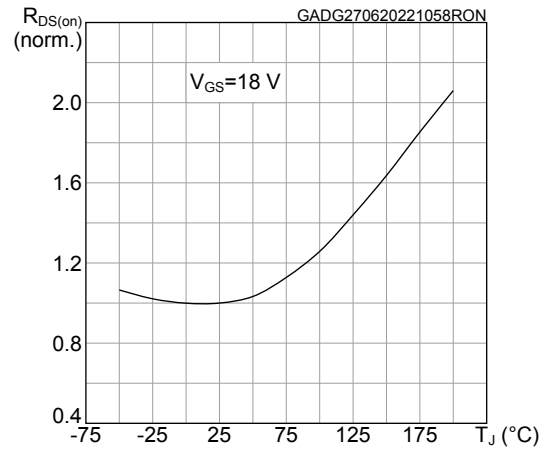

Figure 15. Typical reverse conduction characteristics (T_J = 25 °C)

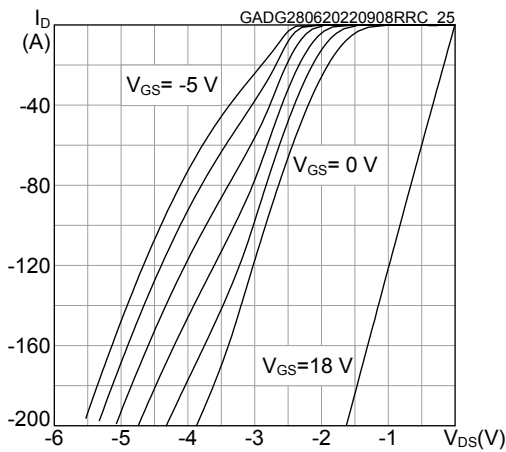
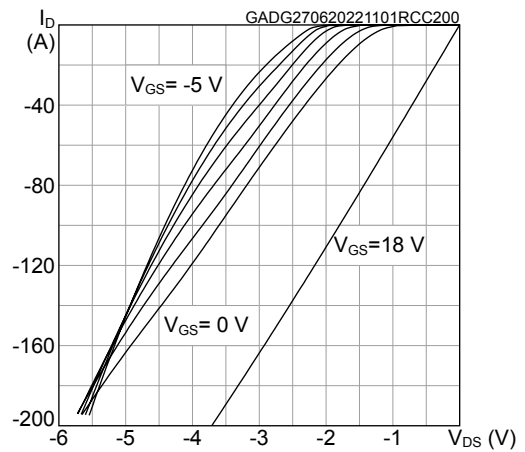

Figure 16. Typical reverse conduction characteristics (T_J = 200 °C)



Prerelease product(s)

3 Package information

In order to meet environmental requirements, ST offers these devices in different grades of **ECOPACK** packages, depending on their level of environmental compliance. ECOPACK specifications, grade definitions and product status are available at: www.st.com. ECOPACK is an ST trademark.

3.1 STPAK package information

Figure 17. STPAK package outline

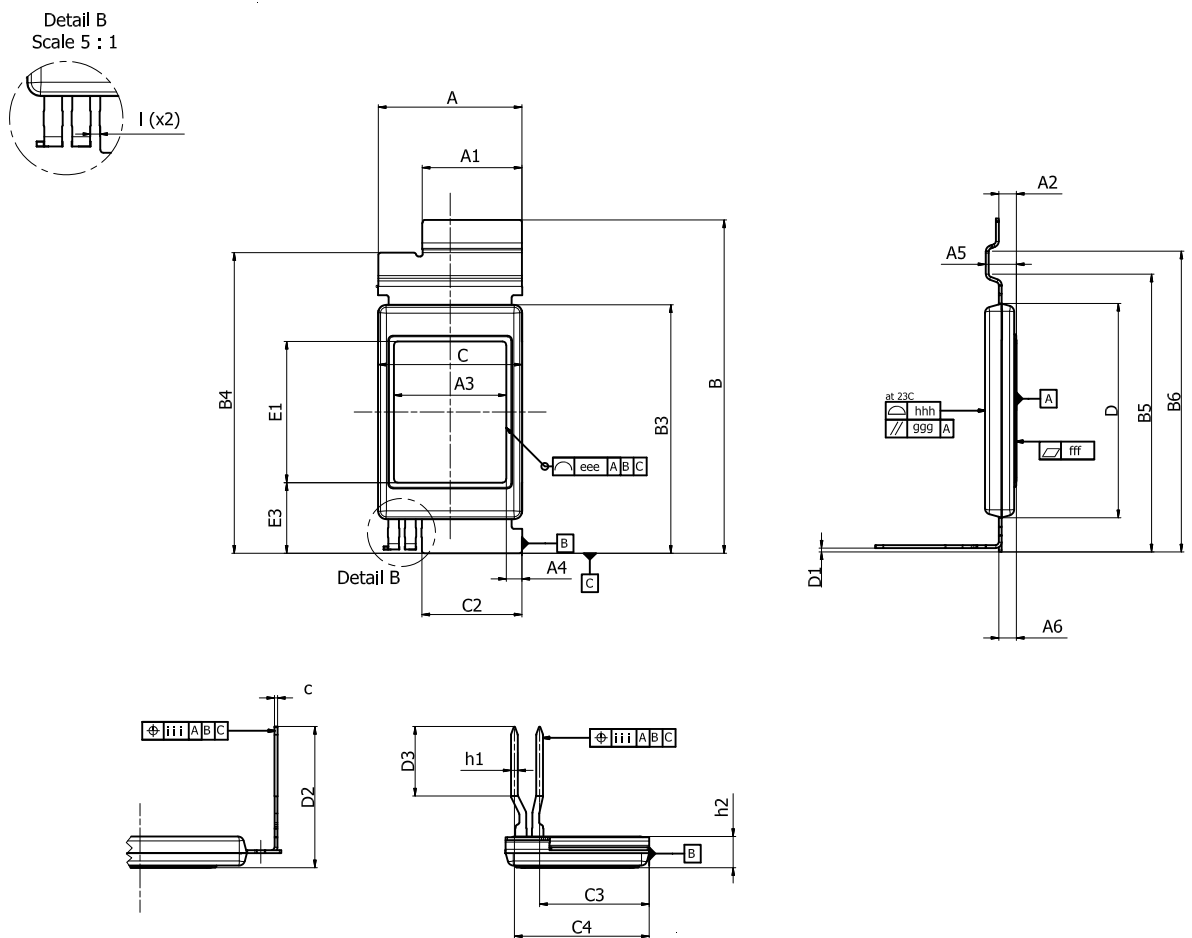

DM00305987_6

Prerelease product(s)

Table 7. STPAK package mechanical data

Ref.	Dimensions			Notes
	mm			
	Min.	Typ.	Max.	
A	18.60	18.80	19.00	
A1	12.85	13.05	13.25	
A2	2.00	2.30	2.60	
A3	14.20	14.70	15.20	Exposed Pad
A4	1.55	2.05	2.55	
A5	3.80	4.00	4.20	
A6	2.10	2.30	2.50	
B	43.40	43.70	44.00	
B3	32.20	32.50	32.80	
B4	39.10	39.40	39.70	
B5	36.07	36.37	36.67	
B6	39.07	39.37	39.67	
c	0.34	0.39	0.44	
C		18.55	19.10	Encompass both large and small cav.
C2	12.90	13.10	13.30	
C3		14.35		
C4		17.65		
D	27.90	28.10	28.30	
D1		0.69		
D2	18.00 (18.50)	18.50 (19.00)	19.00 (19.50)	Refer to the values in brackets for the longer pins type
D3	8.60 (9.10)	9.10 (9.60)	9.60 (10.10)	Refer to the values in brackets for the longer pins type
E1	18.00	18.50	19.00	Exposed pad
E3	8.75	9.25	9.75	
h1	0.85	0.90	0.95	x2 - Pins width
h2	4.00	4.10	4.20	
l	0.60	0.70	0.80	
eee		0.50		
fff	0.10 at 23 °C – 0.05 at 220 °C			Convex with center higher than edges
ggg		0.05		
hhh		0.10		
iii		0.60		

Prerelease product(s)

Revision history

Table 8. Document revision history

Date	Revision	Changes
14-Oct-2022	1	First release.

Contents

1	Electrical ratings	2
2	Electrical characteristics	3
2.1	Electrical characteristics (curves)	4
3	Package information	7
3.1	STPAK package information	7
	Revision history	9

IMPORTANT NOTICE – READ CAREFULLY

STMicroelectronics NV and its subsidiaries (“ST”) reserve the right to make changes, corrections, enhancements, modifications, and improvements to ST products and/or to this document at any time without notice. Purchasers should obtain the latest relevant information on ST products before placing orders. ST products are sold pursuant to ST’s terms and conditions of sale in place at the time of order acknowledgment.

Purchasers are solely responsible for the choice, selection, and use of ST products and ST assumes no liability for application assistance or the design of purchasers’ products.

No license, express or implied, to any intellectual property right is granted by ST herein.

Resale of ST products with provisions different from the information set forth herein shall void any warranty granted by ST for such product.

ST and the ST logo are trademarks of ST. For additional information about ST trademarks, refer to www.st.com/trademarks. All other product or service names are the property of their respective owners.

Information in this document supersedes and replaces information previously supplied in any prior versions of this document.

© 2022 STMicroelectronics – All rights reserved