

Silicon carbide Power MOSFET 650 V, 45 A,
45 mΩ (typ., $T_J = 25\text{ °C}$) in an HiP247 package

HiP247

AM01475v1_noZen

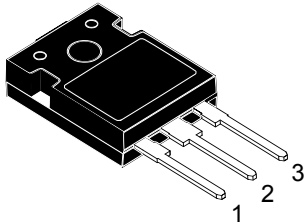
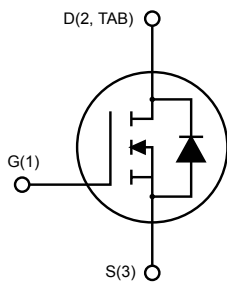

Features

Order code	V_{DS}	$R_{DS(on)}$ typ.	I_D
SCTW35N65G2V	650 V	45 mΩ	45 A

- Very fast and robust intrinsic body diode
- Low capacitance

Applications

- Switching mode power supply
- EV chargers
- DC-DC converters

Description

This silicon carbide Power MOSFET device has been developed using ST's advanced and innovative 2nd generation SiC MOSFET technology. The device features remarkably low on-resistance per unit area and very good switching performance. The variation of switching loss is almost independent of junction temperature.

Product status link

[SCTW35N65G2V](#)

Product summary

Order code	SCTW35N65G2V
Marking	SCT35N65G2V
Package	HiP247
Packing	Tube

1 Electrical ratings

Table 1. Absolute maximum ratings

Symbol	Parameter	Value	Unit
V_{DS}	Drain-source voltage	650	V
V_{GS}	Gate-source voltage	-10 to 22	V
	Gate-source voltage (recommended operating range)	-5 to 20	
I_D	Drain current (continuous) at $T_C = 25\text{ °C}$	45	A
	Drain current (continuous) at $T_C = 100\text{ °C}$	35	
$I_{DM}^{(1)}$	Drain current (pulsed)	90	A
P_{TOT}	Total power dissipation at $T_C = 25\text{ °C}$	240	W
T_{stg}	Storage temperature range	-55 to 200	°C
T_J	Operating junction temperature range		°C

1. Pulse width is limited by safe operating area.

Table 2. Thermal data

Symbol	Parameter	Value	Unit
$R_{thj-case}$	Thermal resistance junction-case	0.72	°C/W
$R_{thj-amb}$	Thermal resistance junction-ambient	40	°C/W

2 Electrical characteristics

($T_{CASE} = 25\text{ °C}$ unless otherwise specified).

Table 3. On/off states

Symbol	Parameter	Test conditions	Min.	Typ.	Max.	Unit
$V_{(BR)DSS}$	Drain-source breakdown voltage	$V_{GS} = 0\text{ V}, I_D = 1\text{ mA}$	650			V
I_{DSS}	Zero gate voltage drain current	$V_{GS} = 0\text{ V}, V_{DS} = 650\text{ V}$			50	μA
		$V_{GS} = 0\text{ V}, V_{DS} = 650\text{ V},$ $T_J = 200\text{ °C}^{(1)}$			100	
I_{GSS}	Gate-body leakage current	$V_{DS} = 0\text{ V}, V_{GS} = -10\text{ to }22\text{ V}$			± 250	nA
$V_{GS(th)}$	Gate threshold voltage	$V_{DS} = V_{GS}, I_D = 1\text{ mA}$	1.8	3.2	5	V
$R_{DS(on)}$	Static drain-source on-resistance	$V_{GS} = 20\text{ V}, I_D = 20\text{ A}$		45	67	m Ω
		$V_{GS} = 18\text{ V}, I_D = 20\text{ A}$		55		
		$V_{GS} = 20\text{ V}, I_D = 20\text{ A},$ $T_J = 200\text{ °C}$		68		

1. Defined by design, not subject to production test.

Table 4. Dynamic

Symbol	Parameter	Test conditions	Min.	Typ.	Max.	Unit
C_{iss}	Input capacitance		-	1370	-	pF
C_{oss}	Output capacitance	$V_{GS} = 0\text{ V}, V_{DS} = 400\text{ V}, f = 1\text{ MHz}$	-	125	-	pF
C_{rss}	Reverse transfer capacitance		-	30	-	pF
R_g	Gate input resistance	$f = 1\text{ MHz}, I_D = 0\text{ A}$	-	2	-	Ω
Q_g	Total gate charge	$V_{DD} = 400\text{ V}, I_D = 20\text{ A},$ $V_{GS} = 0\text{ to }20\text{ V}$	-	73	-	nC
Q_{gs}	Gate-source charge		-	14	-	nC
Q_{gd}	Gate-drain charge		-	27	-	nC

Table 5. Switching energy (inductive load)

Symbol	Parameter	Test conditions	Min.	Typ.	Max.	Unit
E_{on}	Turn-on switching energy	$V_{DD} = 400\text{ V}, I_D = 20\text{ A},$ $R_G = 4.7\text{ }\Omega, V_{GS} = -5\text{ to }20\text{ V}$	-	100	-	μJ
E_{off}	Turn-off switching energy		-	35	-	μJ

Table 6. Switching times

Symbol	Parameter	Test conditions	Min.	Typ.	Max.	Unit
$t_{d(on)}$	Turn-on delay time	$V_{DD} = 400\text{ V}$, $I_D = 20\text{ A}$, $R_G = 4.7\ \Omega$, $V_{GS} = -5\text{ to }20\text{ V}$	-	16	-	ns
t_f	Fall time		-	14	-	ns
$t_{d(off)}$	Turn-off delay time		-	35	-	ns
t_r	Rise time		-	9	-	ns

Table 7. Reverse diode characteristics

Symbol	Parameter	Test conditions	Min.	Typ.	Max.	Unit
V_{SD}	Forward on voltage	$V_{GS} = 0\text{ V}$, $I_F = 20\text{ A}$,	-	4.5	-	V
t_{rr}	Reverse recovery time	$V_{DD} = 400\text{ V}$, $I_F = 20\text{ A}$, $di/dt = 1000\text{ A}/\mu\text{s}$	-	18	-	ns
Q_{rr}	Reverse recovery charge		-	85	-	nC
I_{RRM}	Reverse recovery current		-	7	-	A

2.1 Electrical characteristics (curves)

Figure 1. Safe operating area

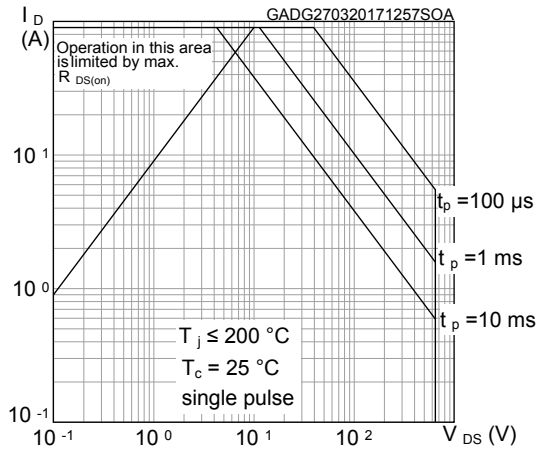

Figure 2. Thermal impedance

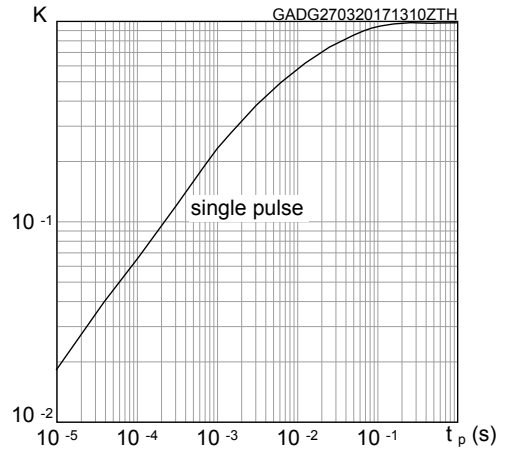

Figure 3. Output characteristics ($T_J = 25\text{ °C}$)

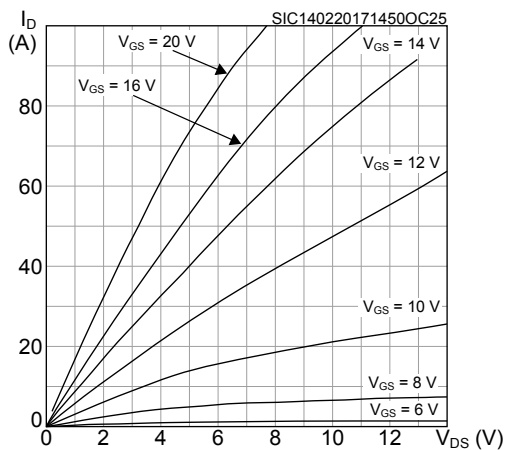

Figure 4. Output characteristics ($T_J = 175\text{ °C}$)

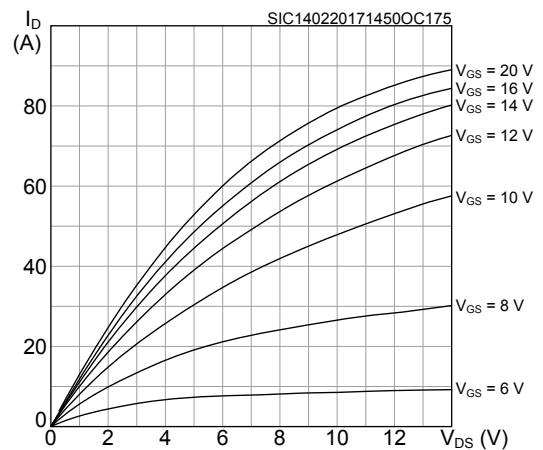

Figure 5. Transfer characteristics

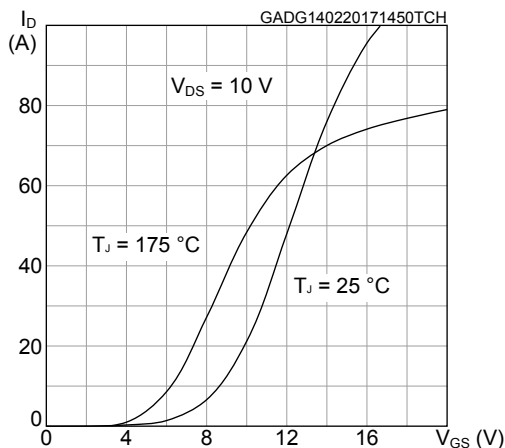

Figure 6. Power dissipation

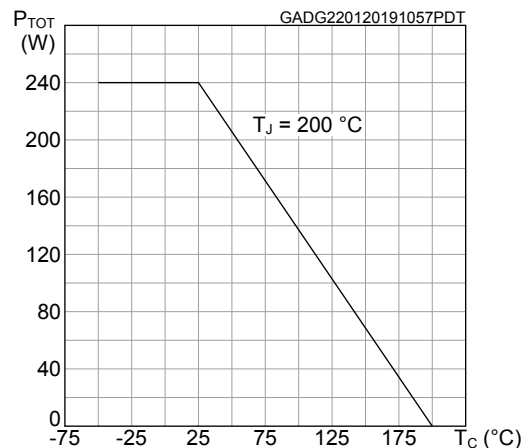

Figure 7. Gate charge vs gate-source voltage

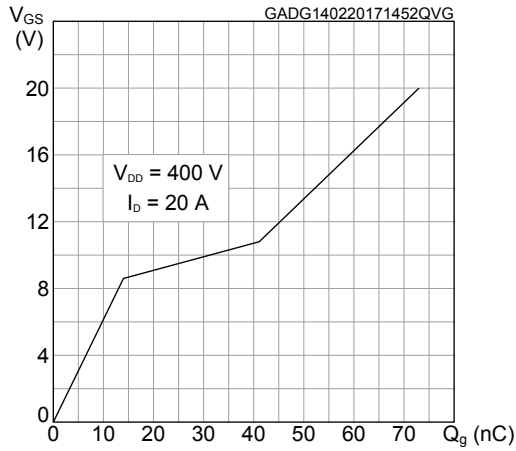

Figure 8. Capacitance variations

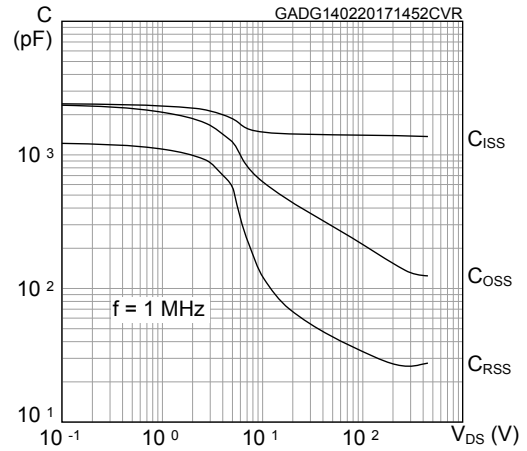

Figure 9. Switching energy vs drain current

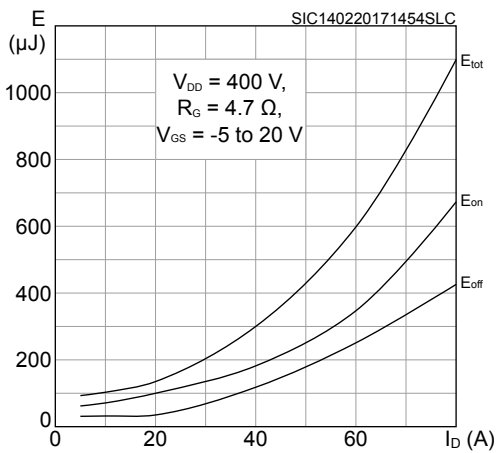

Figure 10. Switching energy vs junction temperature

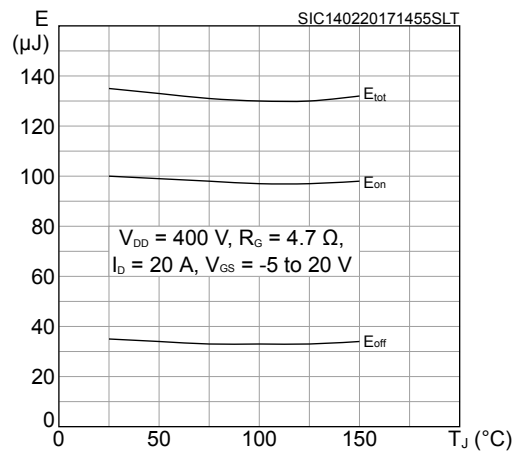

Figure 11. Normalized $V_{(BR)DSS}$ vs temperature

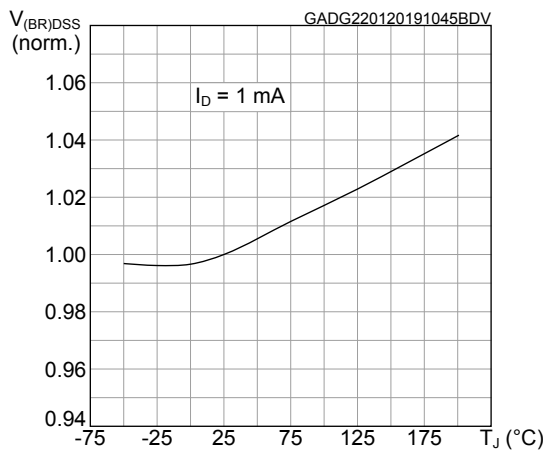

Figure 12. Normalized gate threshold voltage vs temperature

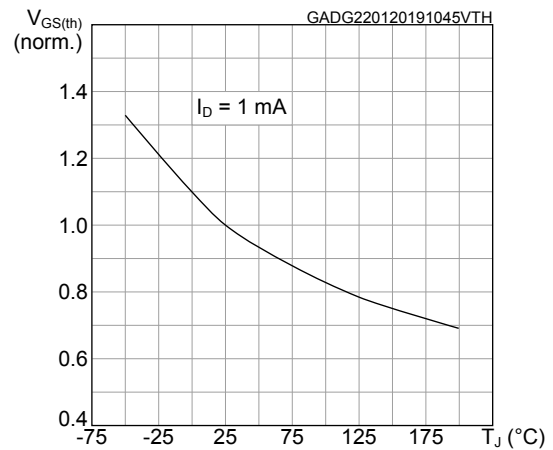

Figure 13. Normalized on-resistance vs temperature

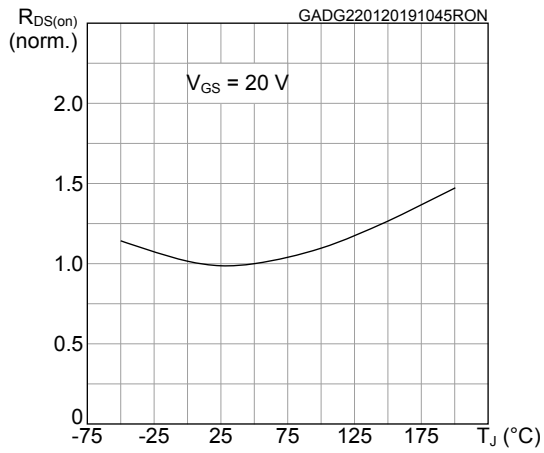

Figure 14. Reverse conduction characteristics ($T_J = 25\text{ °C}$)

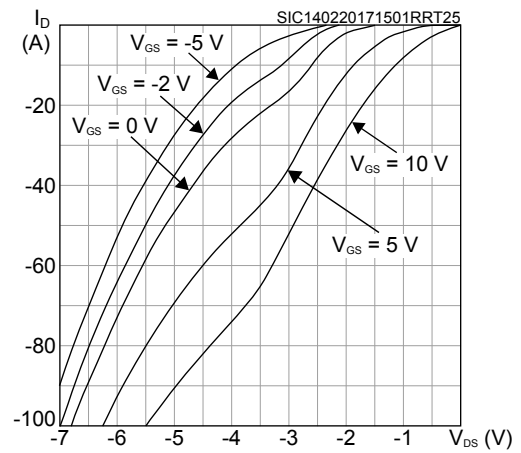
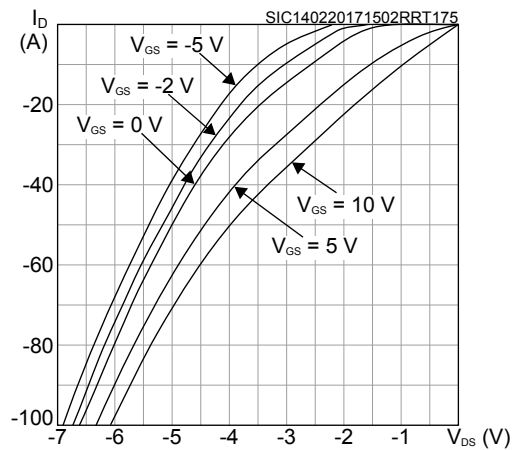

Figure 15. Reverse conduction characteristics ($T_J = 175\text{ °C}$)



3 Package information

In order to meet environmental requirements, ST offers these devices in different grades of **ECOPACK** packages, depending on their level of environmental compliance. ECOPACK specifications, grade definitions and product status are available at: www.st.com. ECOPACK is an ST trademark.

3.1 HiP247 package information

Figure 16. HiP247 package outline

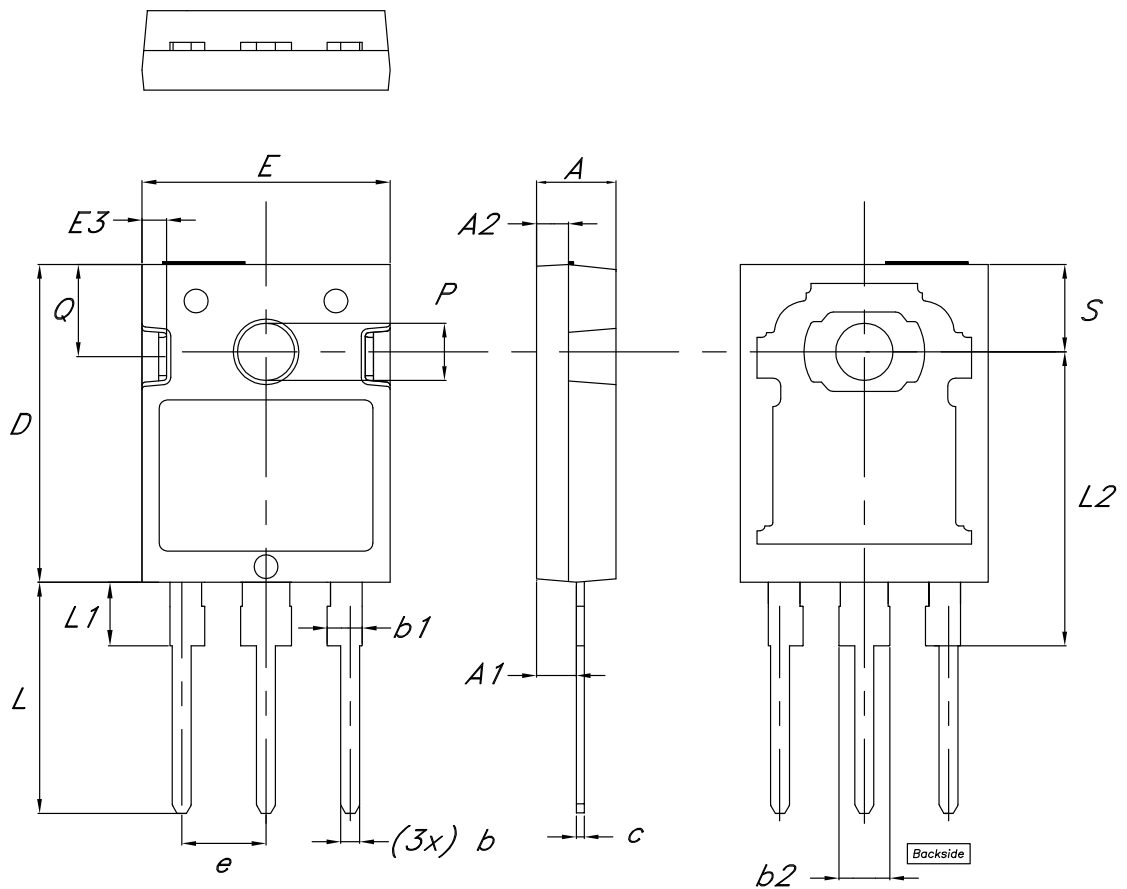

8581091_2

Table 8. HiP247 package mechanical data

Dim.	mm		
	Min.	Typ.	Max.
A	4.85	5.00	5.15
A1	2.20		2.60
A2	1.90	2.00	2.10
b	1.00		1.40
b1	2.00		2.40
b2	3.00		3.40
c	0.40		0.80
D	19.85	20.00	20.15
E	15.45	15.60	15.75
E3	1.45		1.65
e	5.30	5.45	5.60
L	14.20		14.80
L1	3.70		4.30
L2	18.30	18.50	18.70
P	3.55		3.65
Q	5.65		5.95
S	5.30	5.50	5.70

Revision history

Table 9. Document revision history

Date	Revision	Changes
31-Mar-2017	1	First release
12-Dec-2017	2	Modified title. Modified <i>Table 4: "On/off-states"</i> . Minor text changes.
04-Oct-2019	3	Updated title, features and description in cover page. Removed maturity status indication from cover page. The document status is production data. Updated Section 3.1 HiP247 package information . Content reworked to improve readability.

Contents

1	Electrical ratings	2
2	Electrical characteristics	3
2.1	Electrical characteristics (curves)	5
3	Package information	8
3.1	HiP247 package information	8
	Revision history	10

IMPORTANT NOTICE – PLEASE READ CAREFULLY

STMicroelectronics NV and its subsidiaries (“ST”) reserve the right to make changes, corrections, enhancements, modifications, and improvements to ST products and/or to this document at any time without notice. Purchasers should obtain the latest relevant information on ST products before placing orders. ST products are sold pursuant to ST’s terms and conditions of sale in place at the time of order acknowledgement.

Purchasers are solely responsible for the choice, selection, and use of ST products and ST assumes no liability for application assistance or the design of Purchasers’ products.

No license, express or implied, to any intellectual property right is granted by ST herein.

Resale of ST products with provisions different from the information set forth herein shall void any warranty granted by ST for such product.

ST and the ST logo are trademarks of ST. For additional information about ST trademarks, please refer to www.st.com/trademarks. All other product or service names are the property of their respective owners.

Information in this document supersedes and replaces information previously supplied in any prior versions of this document.

© 2019 STMicroelectronics – All rights reserved