

Silicon carbide Power MOSFET 1200 V, 35 mΩ typ., 60 A in an HiP247-4 package

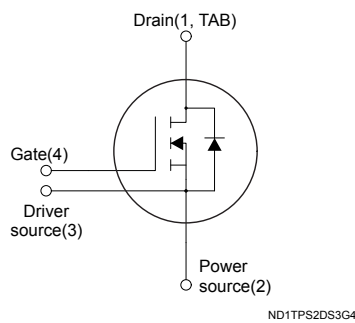
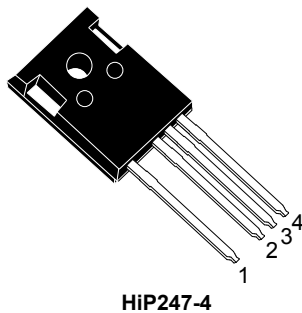

Product status link

[SCTWA60N120G2-4](#)

Product summary

Order code	SCTWA60N120G2-4
Marking	SCT60N120G2
Package	HiP247-4
Packing	Tube

Features

Order code	V _{DS}	R _{DS(on)} max.	I _D
SCTWA60N120G2-4	1200 V	52 mΩ	60 A

- Very fast and robust intrinsic body diode
- Extremely low gate charge and input capacitance
- Very high operating junction temperature capability (T_J = 200 °C)
- Source sensing pin for increased efficiency

Applications

- Switching mode power supply
- DC-DC converters
- Industrial motor control

Description

This silicon carbide Power MOSFET device has been developed using ST's advanced and innovative 2nd generation SiC MOSFET technology. The device features remarkably low on-resistance per unit area and very good switching performance. The variation of switching loss is almost independent of junction temperature.

1 Electrical ratings

Table 1. Absolute maximum ratings

Symbol	Parameter	Value	Unit
V_{DS}	Drain-source voltage	1200	V
V_{GS}	Gate-source voltage	-10 to 22	V
	Gate-source voltage (recommended operational values)	-5 to 18	
I_D	Drain current (continuous) at $T_C = 25\text{ °C}$	60	A
	Drain current (continuous) at $T_C = 100\text{ °C}$	45	
$I_{DM}^{(1)}$	Drain current (pulsed)	177	A
P_{TOT}	Total power dissipation at $T_C = 25\text{ °C}$	388	W
T_{stg}	Storage temperature range	-55 to 200	°C
T_J	Operating junction temperature range		°C

1. Pulse width is limited by safe operating area.

Table 2. Thermal data

Symbol	Parameter	Value	Unit
R_{thJC}	Thermal resistance, junction-to-case	0.45	°C/W
R_{thJA}	Thermal resistance, junction-to-ambient	40	°C/W

2 Electrical characteristics

$T_C = 25\text{ °C}$ unless otherwise specified.

Table 3. On/off states

Symbol	Parameter	Test conditions	Min.	Typ.	Max.	Unit
$V_{(BR)DSS}$	Drain-source breakdown voltage	$V_{GS} = 0\text{ V}$, $I_D = 1\text{ mA}$	1200			V
I_{DSS}	Zero gate voltage drain current	$V_{GS} = 0\text{ V}$, $V_{DS} = 1200\text{ V}$			10	μA
I_{GSS}	Gate-body leakage current	$V_{DS} = 0\text{ V}$, $V_{GS} = -10\text{ to }22\text{ V}$			± 100	nA
$V_{GS(th)}$	Gate threshold voltage	$V_{DS} = V_{GS}$, $I_D = 1\text{ mA}$	1.9	3.0	5.0	V
$R_{DS(on)}$	Static drain-source on-resistance	$V_{GS} = 18\text{ V}$, $I_D = 30\text{ A}$		35	52	m Ω
		$V_{GS} = 18\text{ V}$, $I_D = 30\text{ A}$, $T_J = 200\text{ °C}$		73		

Table 4. Dynamic

Symbol	Parameter	Test conditions	Min.	Typ.	Max.	Unit
C_{iss}	Input capacitance	$V_{DS} = 800\text{ V}$, $f = 1\text{ MHz}$, $V_{GS} = 0\text{ V}$	-	1969	-	pF
C_{oss}	Output capacitance		-	113	-	pF
C_{rss}	Reverse transfer capacitance		-	20	-	pF
R_g	Gate input resistance	$f = 1\text{ MHz}$, $I_D = 0\text{ A}$	-	1	-	Ω
Q_g	Total gate charge	$V_{DS} = 800\text{ V}$, $V_{GS} = -5\text{ to }18\text{ V}$, $I_D = 30\text{ A}$	-	94	-	nC
Q_{gs}	Gate-source charge		-	22	-	nC
Q_{gd}	Gate-drain charge		-	36	-	nC

Table 5. Switching energy (inductive load)

Symbol	Parameter	Test conditions	Min.	Typ.	Max.	Unit
E_{on}	Turn-on switching energy	$V_{DD} = 800\text{ V}$, $I_D = 40\text{ A}$	-	617	-	μJ
E_{off}	Turn-off switching energy	$R_G = 4.7\ \Omega$, $V_{GS} = -5\text{ V to }18\text{ V}$	-	188	-	μJ

Table 6. Switching times

Symbol	Parameter	Test conditions	Min.	Typ.	Max.	Unit
$t_{d(on)}$	Turn-on delay time	$V_{DD} = 800\text{ V}$, $I_D = 30\text{ A}$, $R_G = 4.7\ \Omega$, $V_{GS} = -5\text{ to }18\text{ V}$	-	16	-	ns
t_r	Rise time		-	15	-	ns
$t_{d(off)}$	Turn-off delay time		-	32	-	ns
t_f	Fall time		-	14	-	ns

Table 7. Reverse SiC diode characteristics

Symbol	Parameter	Test conditions	Min.	Typ.	Max.	Unit
V_{SD}	Diode forward voltage	$I_{SD} = 30\text{ A}$, $V_{GS} = 0\text{ V}$	-	3	-	V
t_{rr}	Reverse recovery time	$I_{SD} = 30\text{ A}$, $V_{GS} = 0\text{ V}$, $di/dt = 2000\text{ A}/\mu\text{s}$, $V_{DD} = 800\text{ V}$	-	17	-	ns
Q_{rr}	Reverse recovery charge		-	102	-	nC
I_{RRM}	Reverse recovery current		-	10	-	A

2.1 Electrical characteristics (curves)

Figure 1. Safe operating area

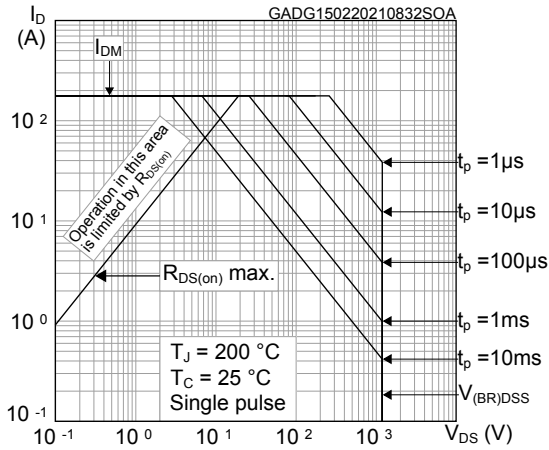

Figure 2. Maximum transient thermal impedance

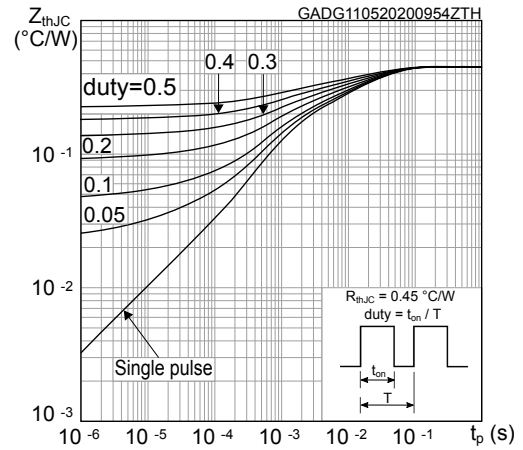

Figure 3. Typical output characteristics ($T_J = 25\text{ °C}$)

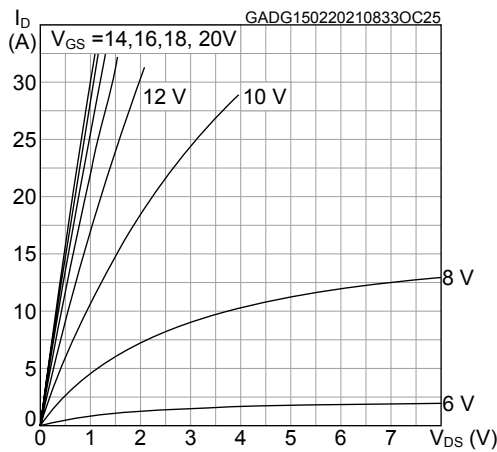

Figure 4. Typical output characteristics ($T_J = 200\text{ °C}$)

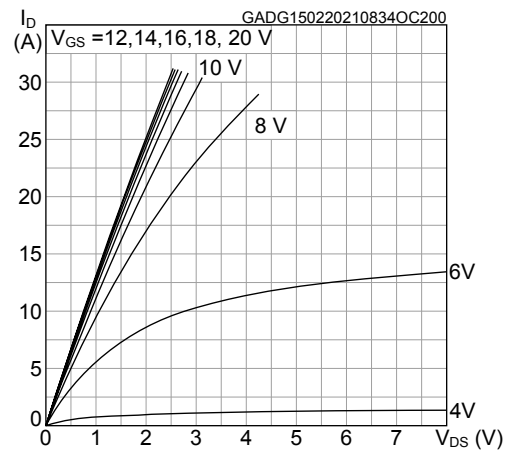

Figure 5. Typical transfer characteristics

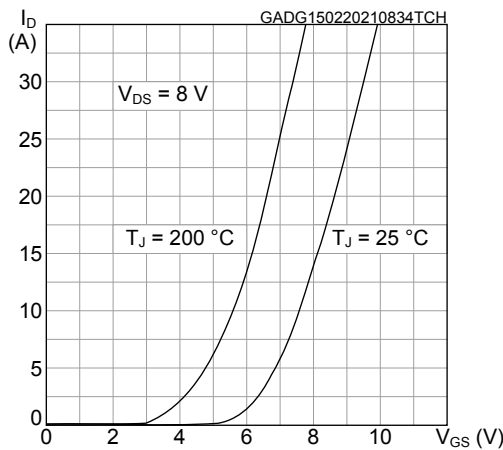

Figure 6. Total power dissipation

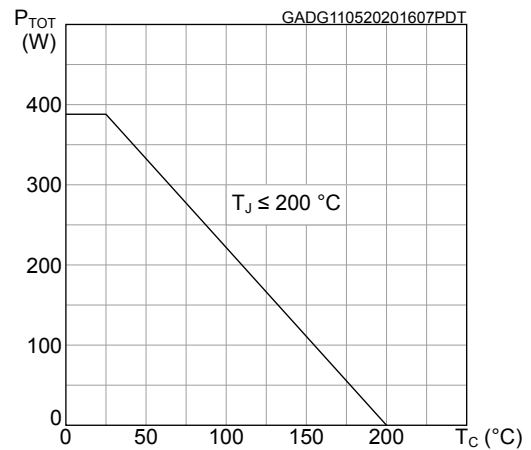

Figure 7. Typical gate charge characteristics

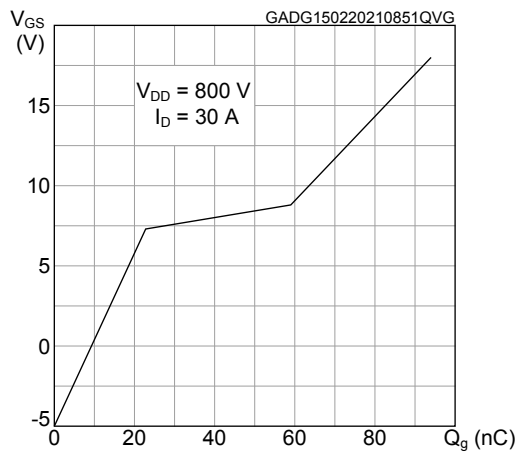

Figure 8. Typical capacitance characteristics

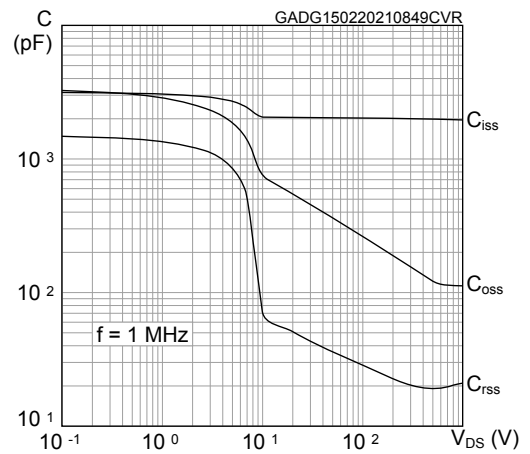

Figure 9. Typical switching energy vs drain current

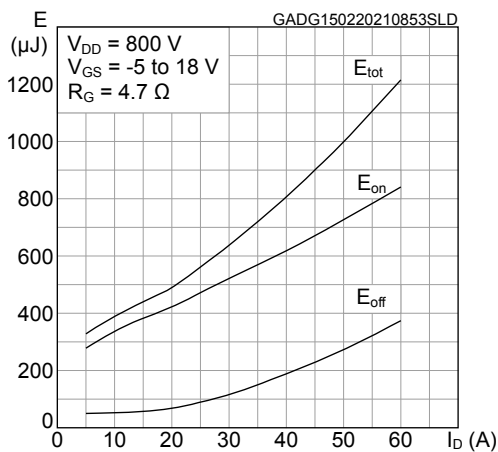

Figure 10. Typical switching energy vs temperature

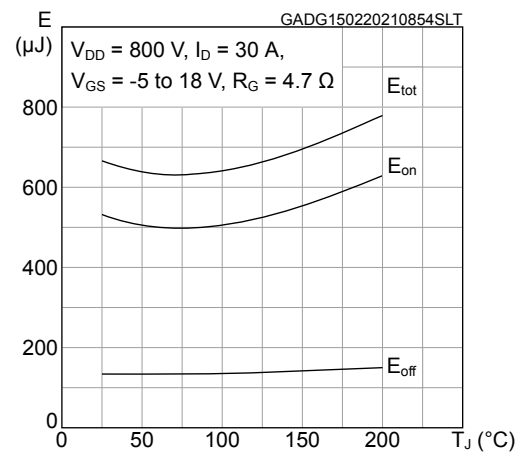

Figure 11. Typical switching energy vs gate resistance

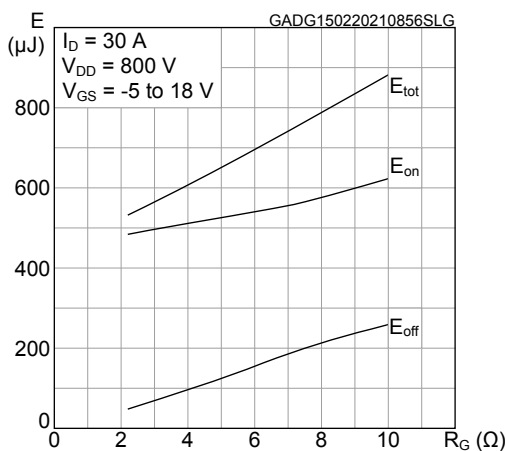

Figure 12. Normalized gate threshold vs temperature

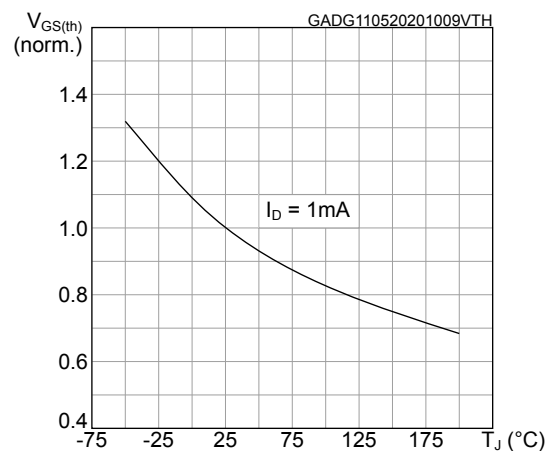

Figure 13. Normalized on-resistance vs temperature

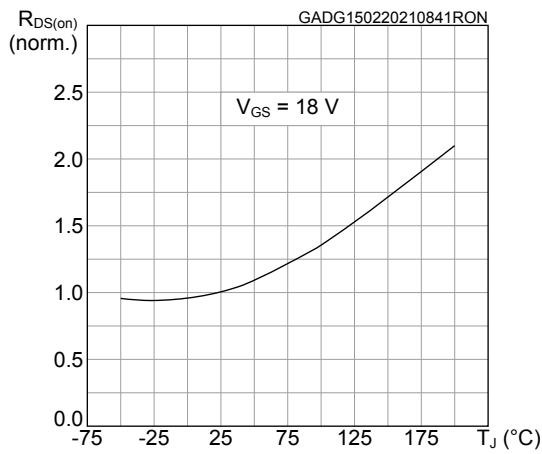

Figure 14. Normalized breakdown voltage vs temperature

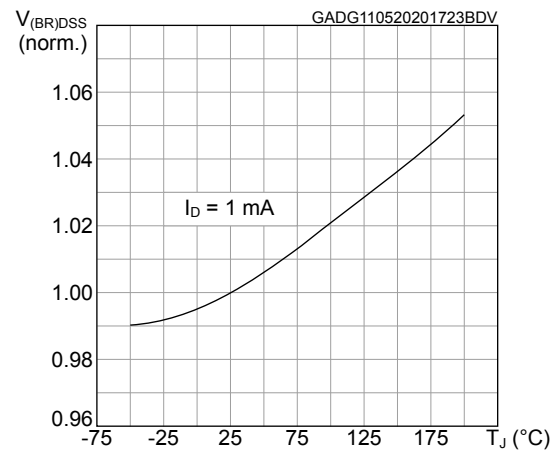

Figure 15. Typical reverse conduction characteristics ($T_J = 25^\circ\text{C}$)

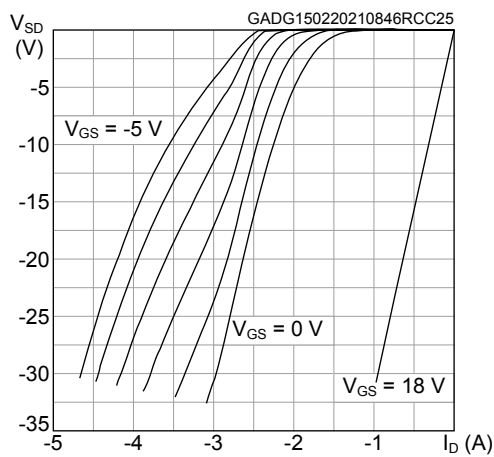
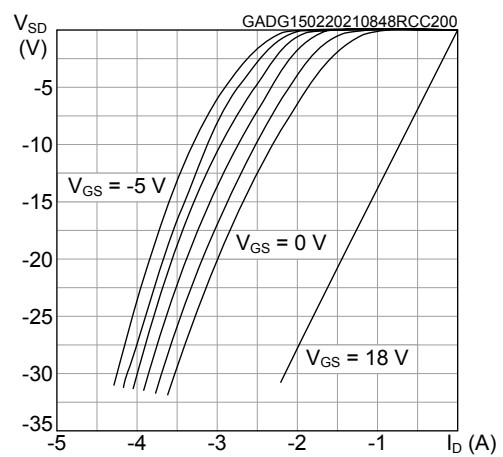

Figure 16. Typical reverse conduction characteristics ($T_J = 200^\circ\text{C}$)



3 Package information

In order to meet environmental requirements, ST offers these devices in different grades of **ECOPACK** packages, depending on their level of environmental compliance. ECOPACK specifications, grade definitions and product status are available at: www.st.com. ECOPACK is an ST trademark.

3.1 HiP247-4 package information

Figure 17. HiP247-4 package outline

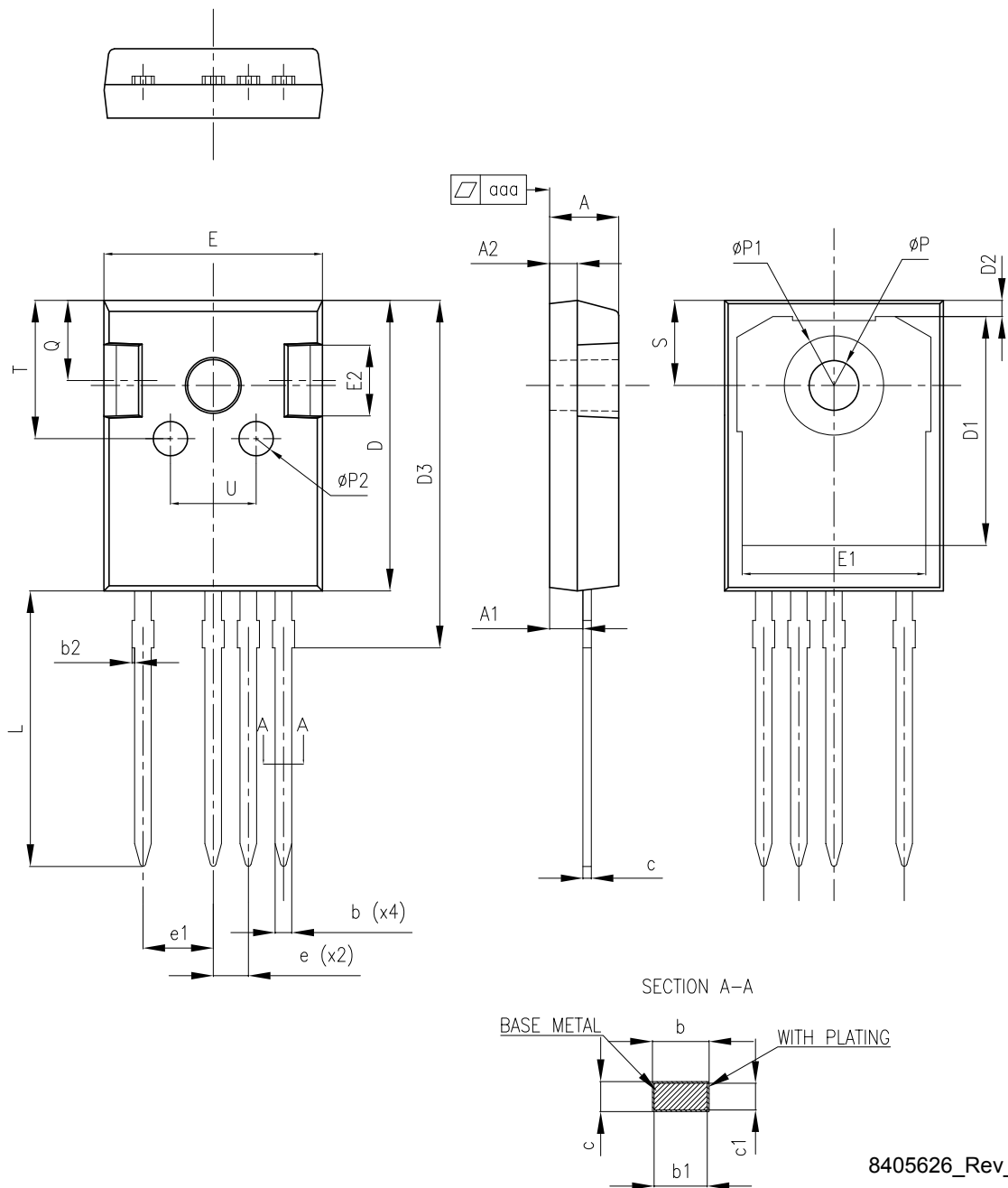

8405626_Rev_3

Table 8. HiP247-4 mechanical data

Dim.	mm		
	Min.	Typ.	Max.
A	4.90	5.00	5.10
A1	2.31	2.41	2.51
A2	1.90	2.00	2.10
b	1.16		1.29
b1	1.15	1.20	1.25
b2	0		0.20
c	0.59		0.66
c1	0.58	0.60	0.62
D	20.90	21.00	21.10
D1	16.25	16.55	16.85
D2	1.05	1.20	1.35
D3	24.97	25.12	25.27
E	15.70	15.80	15.90
E1	13.10	13.30	13.50
E2	4.90	5.00	5.10
E3	2.40	2.50	2.60
e	2.44	2.54	2.64
e1	4.98	5.08	5.18
L	19.80	19.92	20.10
P	3.50	3.60	3.70
P1			7.40
P2	2.40	2.50	2.60
Q	5.60		6.00
S		6.15	
T	9.80		10.20
U	6.00		6.40
aaa		0.04	0.10

Revision history

Table 9. Document revision history

Date	Version	Changes
19-Feb-2021	1	First release.
24-May-2021	2	Modified Table 3 . On/off states. Minor text changes.

Contents

1	Electrical ratings	2
2	Electrical characteristics	3
2.1	Electrical characteristics (curves)	5
3	Package information	8
3.1	HiP247-4 package information	8
	Revision history	10

IMPORTANT NOTICE – PLEASE READ CAREFULLY

STMicroelectronics NV and its subsidiaries (“ST”) reserve the right to make changes, corrections, enhancements, modifications, and improvements to ST products and/or to this document at any time without notice. Purchasers should obtain the latest relevant information on ST products before placing orders. ST products are sold pursuant to ST’s terms and conditions of sale in place at the time of order acknowledgement.

Purchasers are solely responsible for the choice, selection, and use of ST products and ST assumes no liability for application assistance or the design of Purchasers’ products.

No license, express or implied, to any intellectual property right is granted by ST herein.

Resale of ST products with provisions different from the information set forth herein shall void any warranty granted by ST for such product.

ST and the ST logo are trademarks of ST. For additional information about ST trademarks, please refer to www.st.com/trademarks. All other product or service names are the property of their respective owners.

Information in this document supersedes and replaces information previously supplied in any prior versions of this document.

© 2021 STMicroelectronics – All rights reserved