

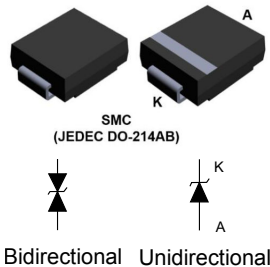

Automotive 3000 W TVS in SMC



Product status link

[SM30T6.8AY](#), [SM30T6.8CAY](#),
[SM30T7.5AY](#), [SM30T7.5CAY](#),
[SM30T10AY](#), [SM30T10CAY](#),
[SM30T12AY](#), [SM30T12CAY](#),
[SM30T15AY](#), [SM30T15CAY](#),
[SM30T18AY](#), [SM30T18CAY](#),
[SM30T19AY](#), [SM30T19CAY](#),
[SM30T21AY](#), [SM30T21CAY](#),
[SM30T23AY](#), [SM30T23CAY](#),
[SM30T26AY](#), [SM30T26CAY](#),
[SM30T28AY](#), [SM30T28CAY](#),
[SM30T30AY](#), [SM30T30CAY](#),
[SM30T33AY](#), [SM30T33CAY](#),
[SM30T35AY](#), [SM30T35CAY](#),
[SM30T39AY](#), [SM30T39CAY](#),
[SM30T42AY](#), [SM30T42CAY](#),
[SM30T47AY](#), [SM30T47CAY](#),
[SM30T56AY](#), [SM30T56CAY](#)
[SM30T68AY](#), [SM30T68CAY](#)
[SM30T75AY](#), [SM30T75CAY](#),
[SM30T82AY](#), [SM30T82CAY](#),
[SM30T100AY](#), [SM30T100CAY](#),
[SM30T117AY](#), [SM30T117CAY](#),
[SM30T152AY](#), [SM30T152CAY](#),
[SM30T180AY](#), [SM30T180CAY](#),
[SM30T200AY](#), [SM30T200CAY](#),
[SM30T220AY](#), [SM30T220CAY](#).

Features

- AEC-Q101 qualified 
- Peak pulse power:
 - 3000 W (10/1000 μ s)
 - up to 40 kW (8/20 μ s)
- Stand-off voltage range from 5 V to 188 V
- Unidirectional and bidirectional types
- Low leakage current: 0.2 μ A at 25 °C
- Operating T_j max: 175 °C
- JEDEC registered package outline
- Lead finishing: matte tin plating

Complies with the following standards

- UL94, V0
- J-STD-020 MSL level 1
- J-STD-002, JESD 22-B102 E3 and MIL-STD-750, method 2026
- JESD-201 class 2 whisker test
- IPC7531 footprint and JEDEC registered package outline
- IEC 61000-4-4 level 4:
 - 4 k V
- ISO 10605, IEC 61000-4-2, C = 150 pF, R = 330 Ω exceeds level 4:
 - 30 kV (air discharge)
 - 30 kV (contact discharge)
- ISO 10605, C = 330 pF, R = 330 Ω exceeds level 4:
 - 30 kV (air discharge)
 - 30 kV (contact discharge)
- ISO 7637-2 (not applicable to parts with V_{RM} lower than battery voltage)
 - Pulse 1: $V_S = -150$ V
 - Pulse 2a: $V_S = +112$ V
 - Pulse 3a: $V_S = -220$ V
 - Pulse3b: $V_S = +150$ V

Description

The SM30TY series are designed to protect sensitive automotive circuits against surges defined in ISO 7637-2 and against electrostatic discharges according to ISO 10605.

The planar technology makes it compatible with high-end circuits where low leakage current and high junction temperature are required to provide long-term reliability and stability.

1 Characteristics

Table 1. Absolute maximum ratings ($T_{amb} = 25\text{ }^{\circ}\text{C}$)

Symbol	Parameter	Value	Unit	
V_{PP}	Peak pulse voltage	ISO10605 (C = 330 pF, R = 330 Ω):	kV	
		Contact discharge		± 30
		Air discharge		± 30
		ISO10605 / IEC 61000-4-2 (C = 150 pF, R = 330 Ω):		
	Contact discharge	± 30		
	Air discharge	± 30		
P_{PP}	Peak pulse power dissipation	T_j initial = T_{amb}	3000	W
T_{stg}	Storage temperature range		-65 to +175	$^{\circ}\text{C}$
T_j	Operating junction temperature range		-55 to +175	$^{\circ}\text{C}$
T_L	Maximum lead temperature for soldering during 10 s		260	$^{\circ}\text{C}$

Figure 1. Electrical characteristics - parameter definitions

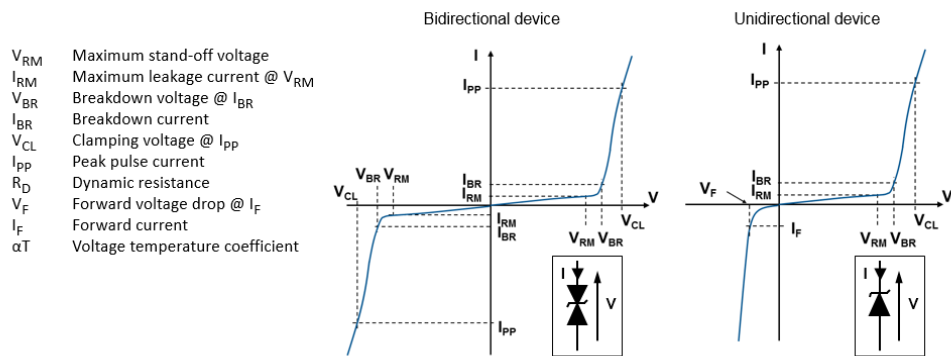

Figure 2. Pulse definition for electrical characteristics

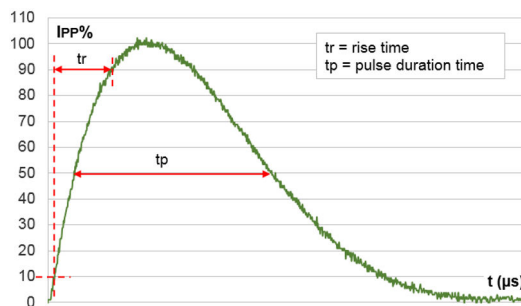

Table 2. Electrical characteristics - parameter values ($T_{amb} = 25\text{ °C}$, unless otherwise specified)

Type	I_{RM} max at V_{RM}			V_{BR} at $I_{BR}^{(1)}$				10 / 1000 μ s			8 / 20 μ s			αT
								$V_{CL}^{(2)(3)}$	$I_{PP}^{(4)}$	R_D	$V_{CL}^{(2)(3)}$	$I_{PP}^{(4)}$	R_D	
	25 °C	85 °C		Min.	Typ.	Max.		Max.		Max.	Max.		Max.	
	μ A	V		V			mA	V	A	m Ω	V	A	m Ω	$10^{-4}/\text{°C}$
SM30T6.8AY/CAY	20	50	5	6.4	6.8	7.1	10	9.2	327	6.42	14.4	1610	4.53	5.7
SM30T7.5AY/CAY	20	50	6.5	7.2	7.5	7.9	10	11.2	268	12.3	15.2	1530	4.77	6.1
SM30T10AY/CAY	10	50	8.5	9.5	10	10.5	1	14.4	208	18.8	18.6	1280	6.33	7.3
SM30T12AY/CAY	0.2	1	10	11.4	12	12.6	1	17	176	25	21.7	1170	7.78	7.8
SM30T15AY/CAY	0.2	1	13	14.2	15	15.8	1	21.5	140	40.7	27.2	993	11.5	8.4
SM30T18AY/CAY	0.2	1	15	16.7	17.6	18.5	1	24.4	123	48	32.5	926	15.1	8.8
SM30T19AY/CAY	0.2	1	16	17.8	18.7	19.6	1	26	115	55.7	34.4	868	17.1	8.8
SM30T21AY/CAY	0.2	1	18	20	21.1	22.2	1	29.2	103	68	39.3	800	21.4	9.2
SM30T23AY/CAY	0.2	1	20	22.2	23.4	24.6	1	32.4	93	83.9	42.8	747	24.4	9.4
SM30T26AY/CAY	0.2	1	22	24.4	25.7	27	1	35.5	85	100	48.3	701	30.4	9.6
SM30T28AY/CAY	0.2	1	24	26.7	28.1	29.5	1	38.9	77	122	50	660	31.1	9.6
SM30T30AY/CAY	0.2	1	26	28.9	30.4	31.9	1	42.1	71	143	53.5	626	34.5	9.7
SM30T33AY/CAY	0.2	1	28	31.1	32.7	34.3	1	45.4	66	168	59	596	41.4	9.8
SM30T35AY/CAY	0.2	1	30	33.3	35.1	36.9	1	48.4	62	185	64.3	569	48.2	9.9
SM30T39AY/CAY	0.2	1	33	36.7	38.6	40.5	1	53.3	56	227	69.7	526	55.5	10
SM30T42AY/CAY	0.2	1	36	40	42.1	44.2	1	58.1	48.4	287	76	503	63.2	10
SM30T47AY/CAY	0.2	1	40	44.4	46.7	49	1	64.5	43.5	356	84	469	74.6	10.1
SM30T56AY/CAY	0.2	1	48	53.2	56	58.8	1	76.6	38.0	468	100	409	101	10.3
SM30T68AY/CAY	0.2	1	58	64.6	68	71.4	1	93.6	32	694	121	325	153	10.4
SM30T75AY/CAY	0.2	1	64	71.3	75	78.8	1	103	29.1	832	134	289	191	10.5
SM30T82AY/CAY	0.2	1	70	77.9	82	86.1	1	113	26.5	1015	146	256	234	10.5
SM30T100AY/CAY	0.2	1	85	95	100	105	1	137	22	1455	178	205	356	10.6
SM30T117AY/CAY	0.2	1	100	111	117	123	1	162	19	2053	212	170	524	10.7
SM30T152AY/CAY	0.2	1	130	144	152	160	1	209	14	3500	265	125	840	10.8
SM30T180AY/CAY	0.2	1	154	171	180	189	1	246	12	4750	317	102	1255	10.8
SM30T200AY/CAY	0.2	1	170	190	200	210	1	275	11	5909	353	90	1589	10.8
SM30T220AY/CAY	0.2	1	188	209	220	231	1	328	9	10778	388	80	1963	10.8

1. To calculate V_{BR} versus T_j : V_{BR} at $T_j = V_{BR}$ at $25\text{ °C} \times (1 + \alpha T \times (T_j - 25))$
2. To calculate V_{CL} versus T_j : V_{CL} at $T_j = V_{CL}$ at $25\text{ °C} \times (1 + \alpha T \times (T_j - 25))$
3. To calculate V_{CL} max versus $I_{PPappli}$: $V_{CLmax} = V_{BRmax} + R_D \times I_{PPappli}$
4. Surge capability given for both directions for unidirectional and bidirectional devices

1.1 Characteristics (curves)

Figure 3. Maximum peak power dissipation versus initial junction temperature

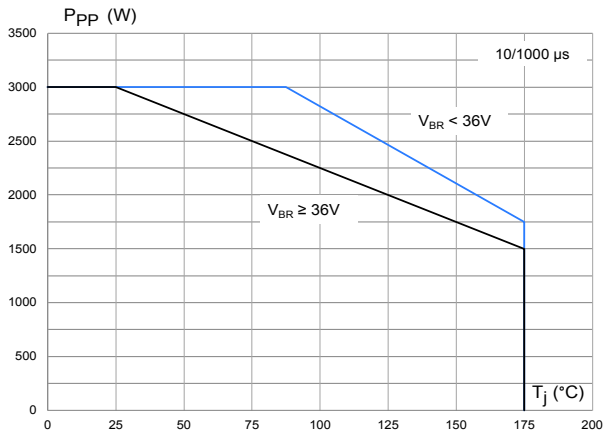

Figure 4. Maximum peak pulse power versus exponential pulse duration

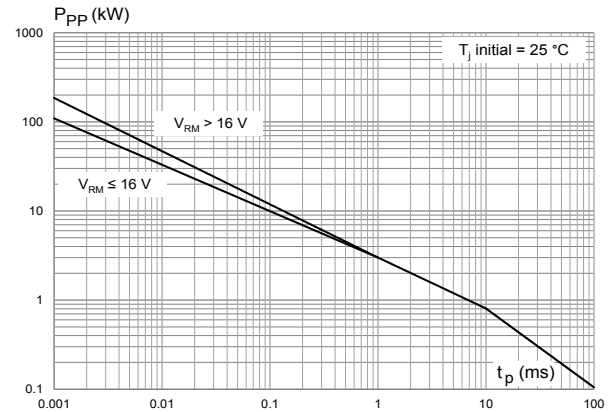

Figure 5. Maximum peak pulse current versus clamping voltage

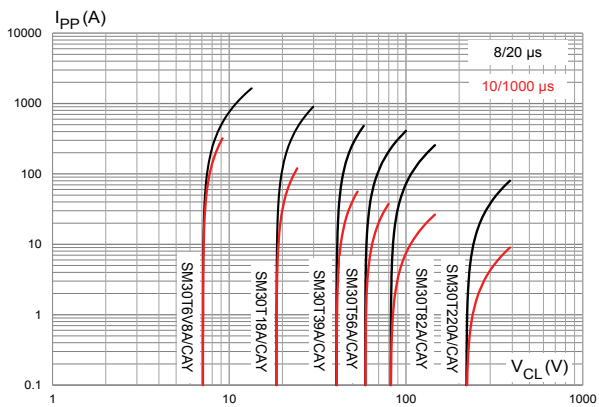

Figure 6. Dynamic resistance versus pulse duration

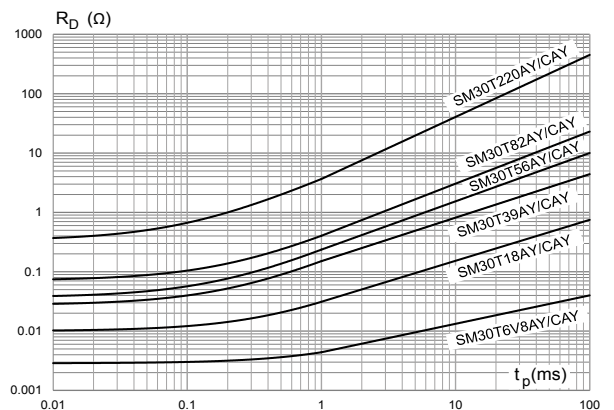

Figure 7. Junction capacitance versus reverse applied voltage (unidirectional type)

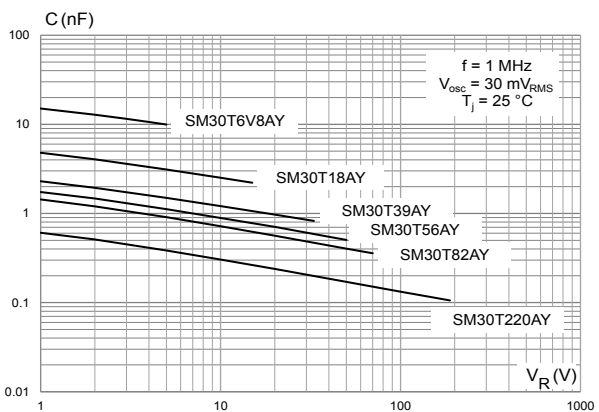

Figure 8. Junction capacitance versus applied voltage (bidirectional type)

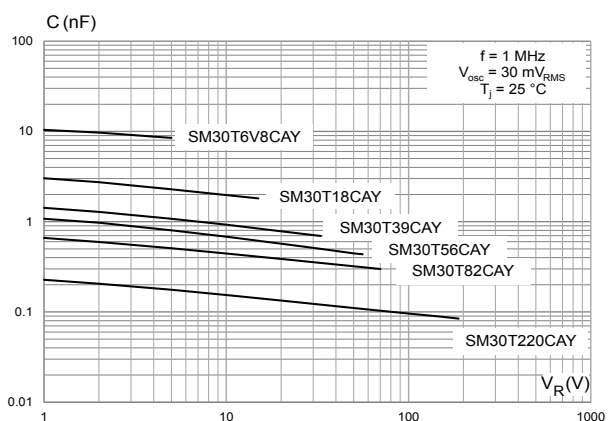

Figure 9. Leakage current versus junction temperature

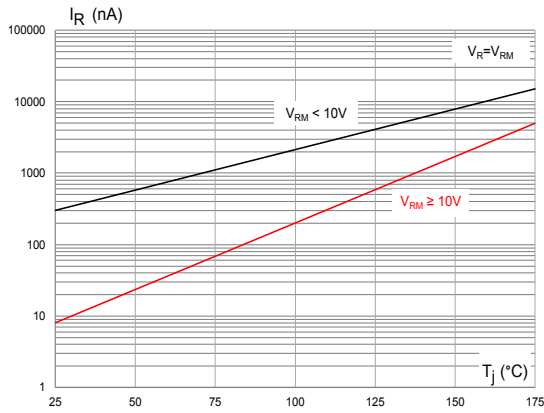

Figure 10. Peak forward voltage drop versus peak forward current

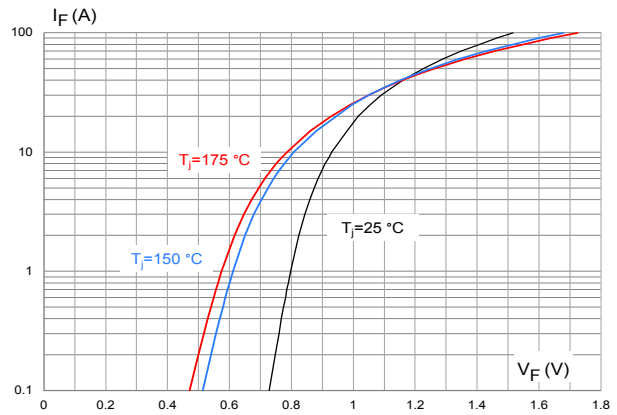

Figure 11. Thermal impedance junction to ambient versus pulse duration

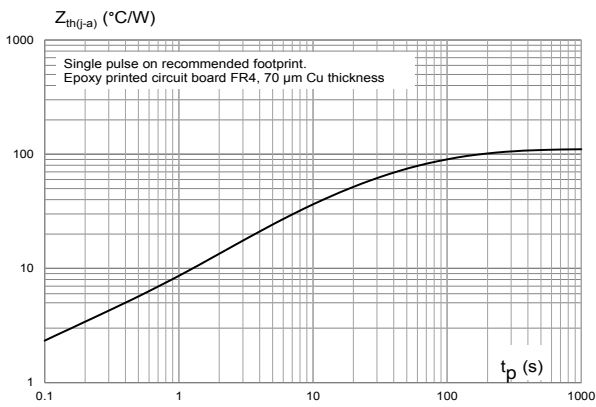

Figure 12. Thermal resistance junction to ambient versus copper area under each lead

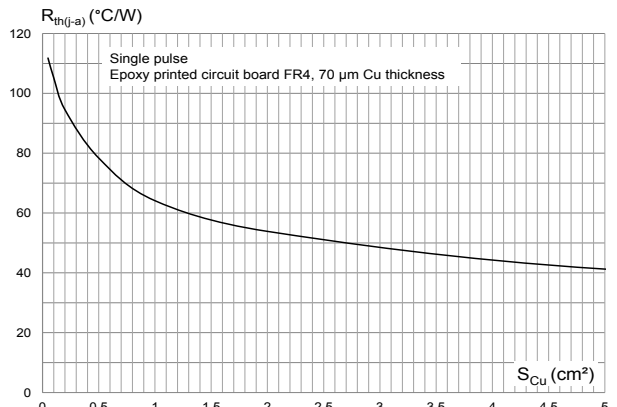

Figure 13. ISO7637-2 pulse 1a response ($V_S = -150\text{ V}$) with 12 V battery

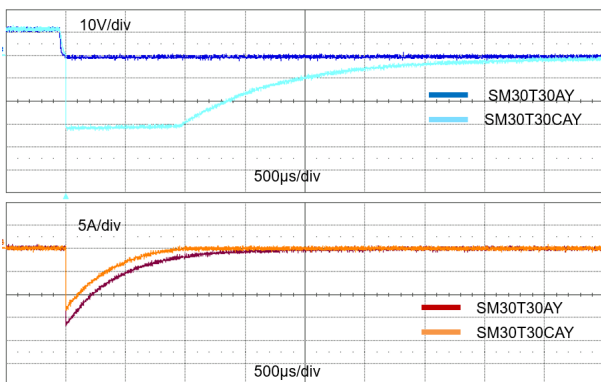

Figure 14. ISO7637-2 pulse 2a response ($V_S = 112\text{ V}$) with 12 V battery

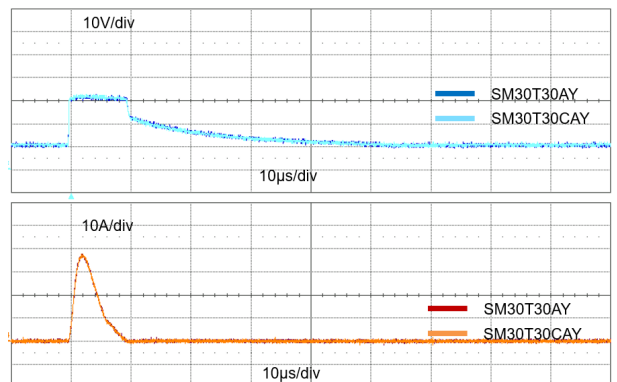

Figure 15. ISO7637-2 pulse 3a response ($V_S = -220\text{ V}$) with 12 V battery

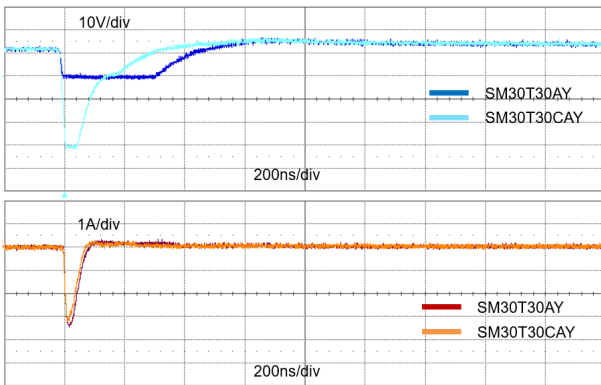

Figure 16. ISO7637-2 pulse 3b response ($V_S = 150\text{ V}$) with 12 V battery

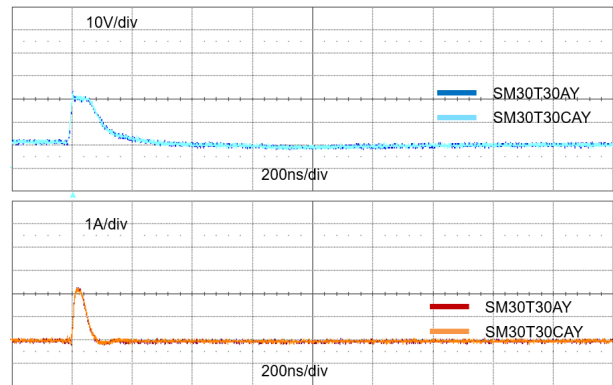

Figure 17. ISO7637-2 pulse 5b definition

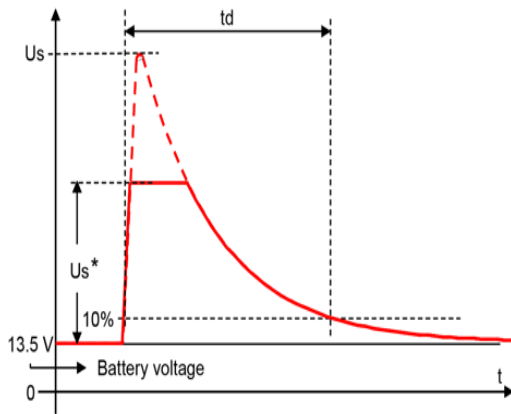

Figure 18. Load dump capability ($U_s^* = f(R_i)$ pulse 5b, $U_s = 87\text{ V}$, $t_p = 150\text{ ms}$)

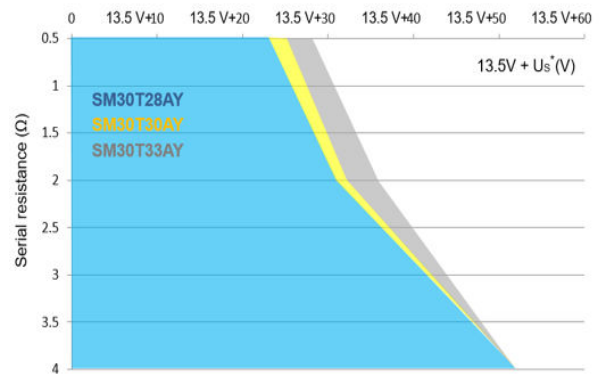

Figure 19. Load dump capability ($U_s^* = f(R_i)$ pulse 5b, $U_s = 87\text{ V}$, $t_p = 400\text{ ms}$)

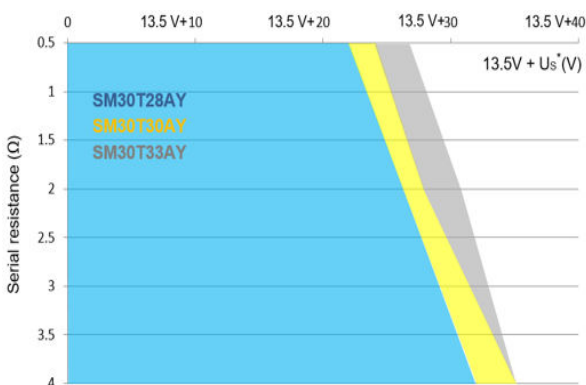
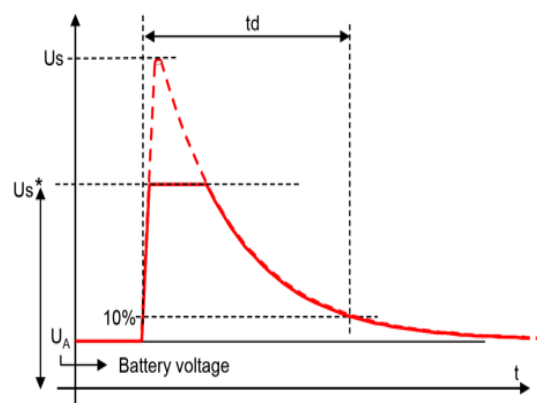
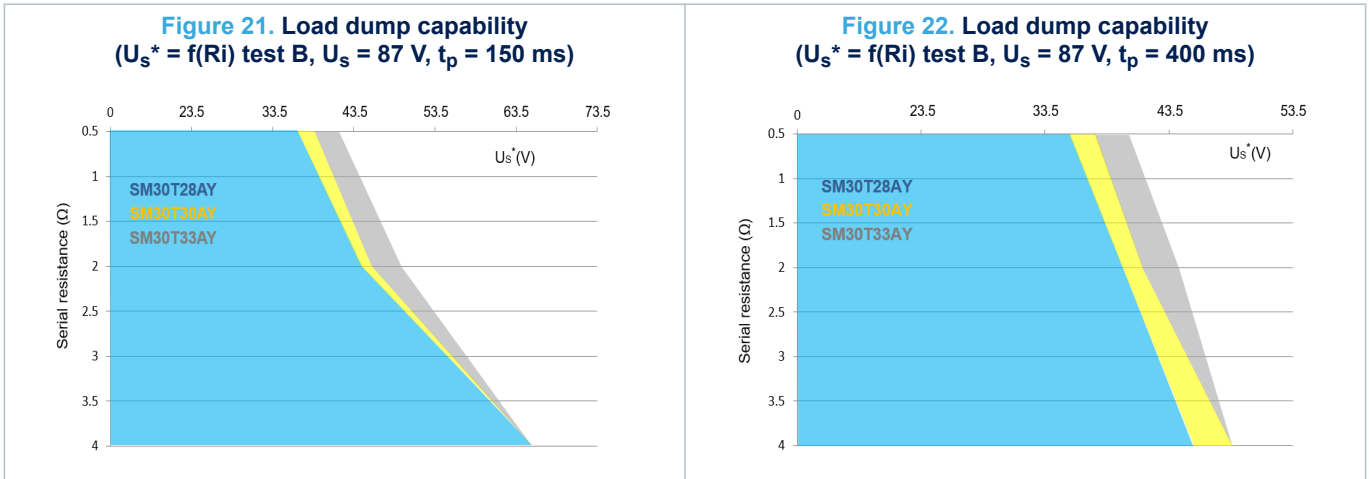

Figure 20. ISO16750-2 test B definition





Note: Load dump capability curves are performed with SCHAFFNER GENERATOR Model LD 5505.

2 Package information

In order to meet environmental requirements, ST offers these devices in different grades of **ECOPACK** packages, depending on their level of environmental compliance. ECOPACK specifications, grade definitions and product status are available at: www.st.com. ECOPACK is an ST trademark.

2.1 SMC package information

Figure 23. SMC package outline

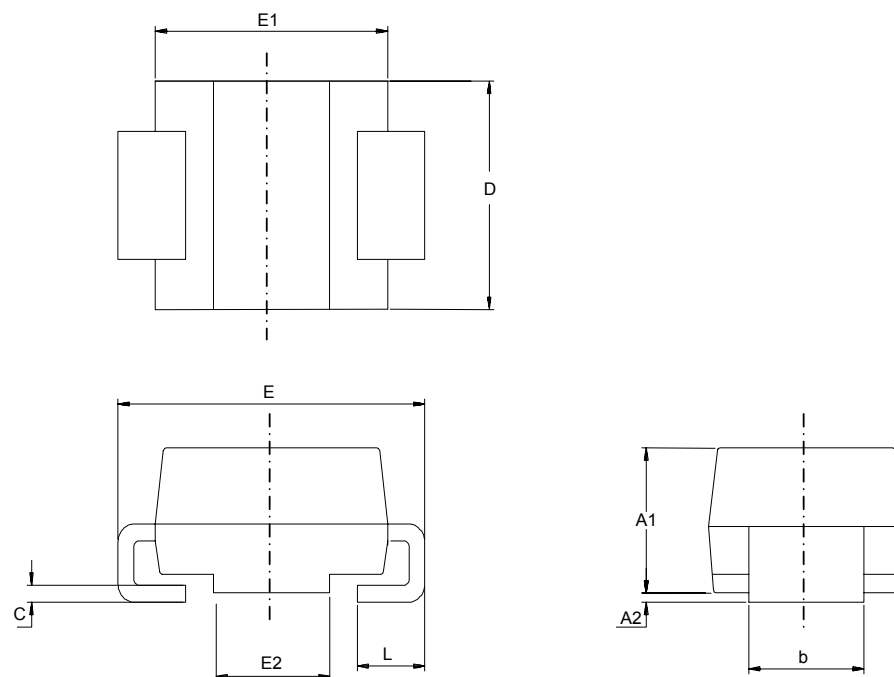

Table 3. SMC package mechanical data

Ref.	Dimensions			
	Millimeters		Inches ⁽¹⁾	
	Min.	Max.	Min.	Max.
A1	1.90	2.45	0.075	0.096
A2	0.05	0.20	0.002	0.008
b	2.90	3.20	0.114	0.126
c	0.15	0.40	0.006	0.016
D	5.55	6.25	0.218	0.246
E	7.75	8.15	0.305	0.321
E1	6.60	7.15	0.260	0.281
E2	4.40	4.70	0.173	0.185
L	0.75	1.50	0.030	0.060

1. Values in inches are converted from mm.

Figure 24. Footprint recommendation

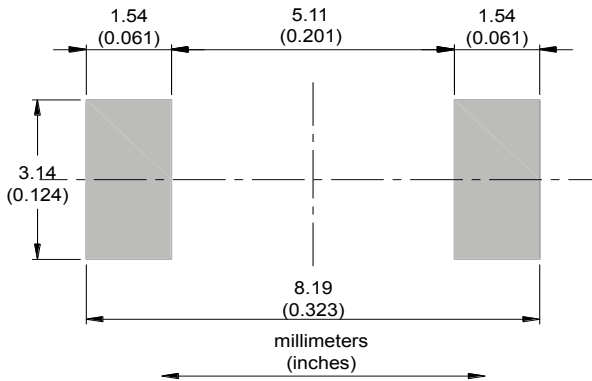

Figure 25. Marking layout

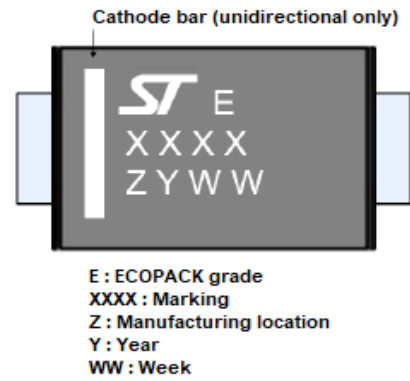
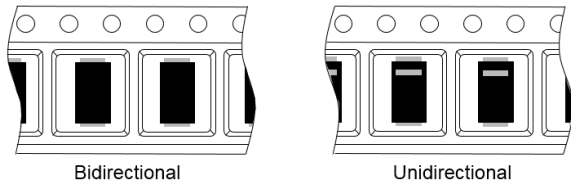

Figure 26. Package orientation in reel



Taped according to EIA-481
Pocket dimensions are not on scale.
Pocket shape may vary depending on package
On bidirectional devices, marking and logo may not be always in the same direction.

Figure 27. Tape and reel orientation

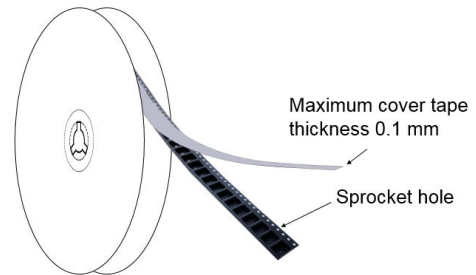

Figure 28. 13" reel dimension values (mm)

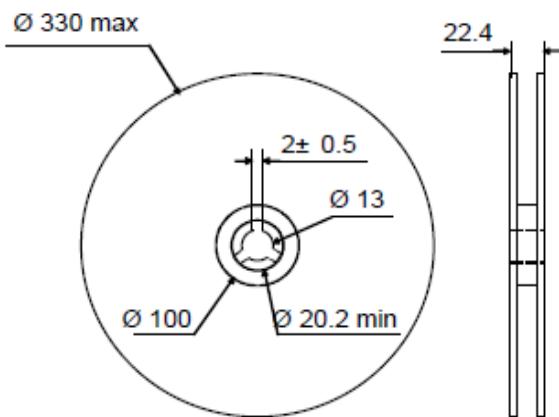

Figure 29. Inner box dimension values (mm)

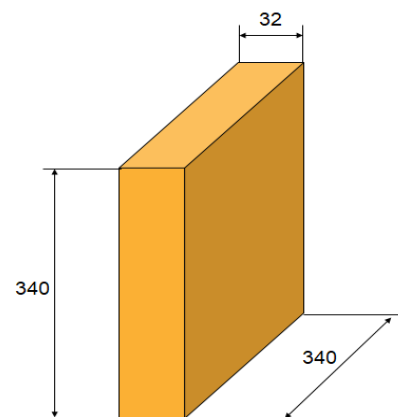
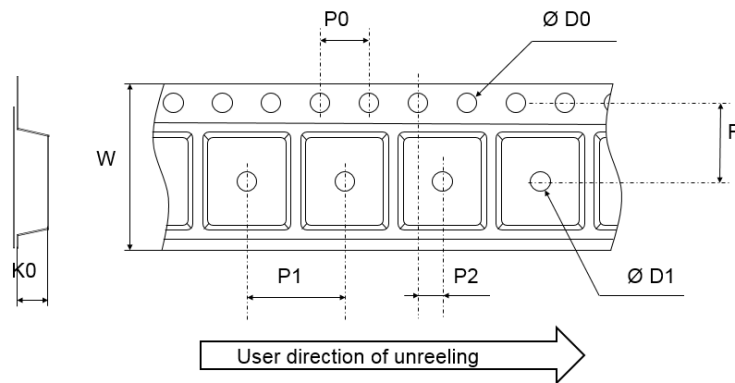

Figure 30. Tape outline



Note: Pocket dimensions are not on scale
Pocket shape may vary depending on package

Table 4. Tape dimension values

Ref.	Dimensions		
	Millimeters		
	Min.	Typ.	Max.
D0	1.4	1.5	1.6
D1	1.5		
F	7.4	7.5	7.6
K0	2.39	2.49	2.59
P0	3.9	4.0	4.1
P1	7.9	8.0	8.1
P2	1.9	2.0	2.1
W	15.7	16	16.3

2.2 Reflow profile

Figure 31. ST ECOPACK recommended soldering reflow profile for PCB mounting

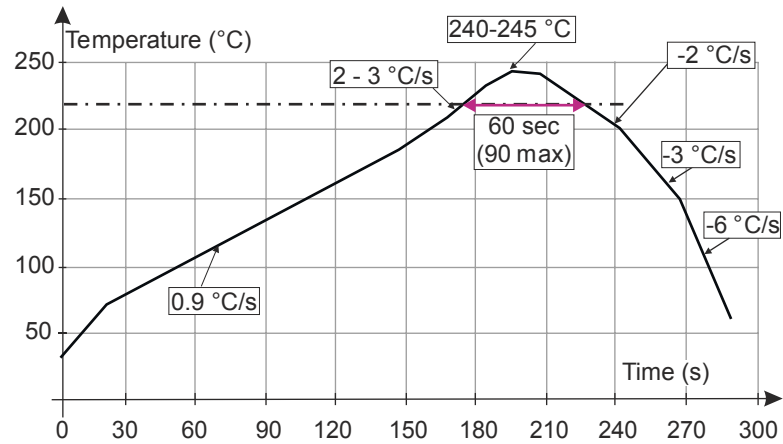

Note: Minimize air convection currents in the reflow oven to avoid component movement. Maximum soldering profile corresponds to the latest IPC/JEDEC J-STD-020.

3 Application and design guidelines

More information is available in the application note AN2689 “Protection of automotive electronics from electrical hazards, guidelines for design and component selection”.

4 Ordering information

Table 5. Ordering information

Order code	Marking	Package	Weight	Base qty.	Delivery mode
SM30TxxAY/CAY ⁽¹⁾	See Table 6. Marking.	SMC	0.25 g	2500	Tape and reel

1. Where xx is nominal value of V_{BR} and A or CA indicates unidirectional or bidirectional version.

4.1 Marking

Table 6. Marking

Order code	Marking	Order code	Marking
SM30T6.8AY	3AAAY	SM30T6.8CAY	3BAAY
SM30T7.5AY	3AACY	SM30T7.5CAY	3BACY
SM30T10AY	3AADY	SM30T10CAY	3BADY
SM30T12AY	3AAWY	SM30T12CAY	3BAWY
SM30T15AY	3AAGY	SM30T15CAY	3BAGY
SM30T18AY	3AAHY	SM30T18CAY	3BAHY
SM30T19AY	3AAIY	SM30T19CAY	3BAIY
SM30T21AY	3AAJY	SM30T21CAY	3BAJY
SM30T23AY	3AAKY	SM30T23CAY	3BAKY
SM30T26AY	3AALY	SM30T26CAY	3BALY
SM30T28AY	3AAEY	SM30T28CAY	3BAEY
SM30T30AY	3AAMY	SM30T30CAY	3BAMY
SM30T33AY	3AANY	SM30T33CAY	3BANY
SM30T35AY	3AAOY	SM30T35CAY	3BAOY
SM30T39AY	3AAPY	SM30T39CAY	3BAPY
SM30T42AY	3AAQY	SM30T42CAY	3BAQY
SM30T47AY	3AARY	SM30T47CAY	3BARY
SM30T56AY	3AASY	SM30T56CAY	3BASY
SM30T68AY	3ACYY	SM30T68CAY	3BCYY
SM30T75AY	3ADEY	SM30T75CAY	3BDEY
SM30T82AY	3ADKY	SM30T82CAY	3BDKY
SM30T100AY	3ADZY	SM30T100CAY	3BDZY
SM30T117AY	3AEOY	SM30T117CAY	3BEOY
SM30T152AY	3AFSY	SM30T152CAY	3BFSY
SM30T180AY	3AGQY	SM30T180CAY	3BGQY
SM30T200AY	3AHGY	SM30T200CAY	3BHYG
SM30T220AY	3AHYY	SM30T220CAY	3BHYY

Revision history

Table 7. Document revision history

Date	Version	Changes
28-Jul-2011	1	Initial release.
27-Mar-2012	2	Updated footnote on page 1. Removed Table 2. Thermal parameter.
02-Jun-2014	3	Updated : Features, Table 2, Table 4 and reformatted to current standard.
09-Jan-2015	4	Updated Features, Table 2, Table 4, Figure 5 to Figure 8 and Figure 11 to Figure 21.
13-Jul-2015	5	Updated features in cover page, Table 1, Table 2 and Table 4. Updated Figure 3, Figure 5, Figure 6, Figure 7, Figure 8, Figure 9, Figure 11, Figure 12, Figure 13, Figure 14, Figure 15, Figure 17, Figure 18, Figure 20 and Figure 21.
27-Jul-2015	6	Updated Figure 10 and Figure 15.
02-Sep-2019	7	Updated Table 2. Electrical characteristics - parameter values ($T_{amb} = 25\text{ }^{\circ}\text{C}$, unless otherwise specified) and Section 1.1 Characteristics (curves).
17-Oct-2019	8	Updated Section 2.1 SMC package information.
03-Nov-2021	9	Updated Figure 11.
31-Jan-2022	10	Range extension up to 188 V.
21-Mar-2022	11	Minor text changes.
21-Feb-2023	12	Removed leakage current and thermal resistance figures. Minor text changes.
15-Dec-2023	13	Updated Table 2, Figure 3, Figure 9, and Figure 10. Minor text changes.

IMPORTANT NOTICE – READ CAREFULLY

STMicroelectronics NV and its subsidiaries (“ST”) reserve the right to make changes, corrections, enhancements, modifications, and improvements to ST products and/or to this document at any time without notice. Purchasers should obtain the latest relevant information on ST products before placing orders. ST products are sold pursuant to ST’s terms and conditions of sale in place at the time of order acknowledgment.

Purchasers are solely responsible for the choice, selection, and use of ST products and ST assumes no liability for application assistance or the design of purchasers’ products.

No license, express or implied, to any intellectual property right is granted by ST herein.

Resale of ST products with provisions different from the information set forth herein shall void any warranty granted by ST for such product.

ST and the ST logo are trademarks of ST. For additional information about ST trademarks, refer to www.st.com/trademarks. All other product or service names are the property of their respective owners.

Information in this document supersedes and replaces information previously supplied in any prior versions of this document.

© 2023 STMicroelectronics – All rights reserved