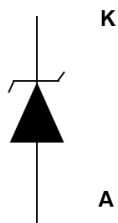
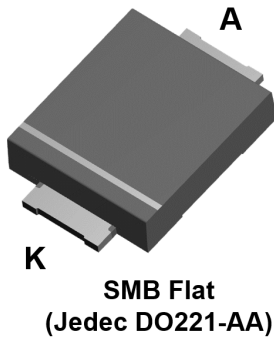


## 600 W TVS in SMB Flat



Unidirectional

## Features

- Peak pulse power: 600 W (10/1000  $\mu$ s) and 4 kW (8/20  $\mu$ s)
- Flat and thin package: 1 mm
- Stand-off voltage range from 5 V to 188 V
- Unidirectional type
- Low leakage current: 0.2  $\mu$ A at 25 °C and 1  $\mu$ A at 85 °C
- Operating  $T_j$  max: 175 °C
- High power capability at  $T_j$  max.: up to 470 W (10/1000  $\mu$ s)
- Lead finishing: matte tin plating

## Complies with the following standards

- UL94, V0
- J-STD-020 MSL level 1
- J-STD-002, JESD 22-B102 E3 and MIL-STD-750, method 2026 solderable matte tin plated leads
- JESD-201 class 2 whisker test
- IPC7531 footprint
- JEDEC registered package outline
- IEC 61000-4-4 level 4:
  - 4 kV
- IEC 61000-4-2, C= 150 pF - R = 330  $\Omega$  exceeds level 4:
  - 30 kV (air discharge)
  - 30 kV (contact discharge)

## Description

The SMB6FxxA series are designed to protect sensitive circuits against surges.

The Planar technology makes it compatible with high-end circuits where low leakage current and high junction temperature are required to provide long term reliability and stability.

## Product status link

Product status link	
SMB6F	<a href="#">SMB6F5.0A</a> , <a href="#">SMB6F6.0A</a> , <a href="#">SMB6F6.5A</a> , <a href="#">SMB6F8.5A</a> , <a href="#">SMB6F10A</a> , <a href="#">SMB6F11A</a> , <a href="#">SMB6F13A</a> , <a href="#">SMB6F12A</a> , <a href="#">SMB6F14A</a> , <a href="#">SMB6F15A</a> , <a href="#">SMB6F16A</a> , <a href="#">SMB6F18A</a> , <a href="#">SMB6F20A</a> , <a href="#">SMB6F22A</a> , <a href="#">SMB6F23A</a> , <a href="#">SMB6F24A</a> , <a href="#">SMB6F26A</a> , <a href="#">SMB6F28A</a> , <a href="#">SMB6F30A</a> , <a href="#">SMB6F31A</a> , <a href="#">SMB6F33A</a> , <a href="#">SMB6F36A</a> , <a href="#">SMB6F40A</a> , <a href="#">SMB6F48A</a> , <a href="#">SMB6F58A</a> , <a href="#">SMB6F64A</a> , <a href="#">SMB6F70A</a> , <a href="#">SMB6F85A</a> , <a href="#">SMB6F100A</a> , <a href="#">SMB6F130A</a> , <a href="#">SMB6F154A</a> , <a href="#">SMB6F170A</a> , <a href="#">SMB6F188A</a>

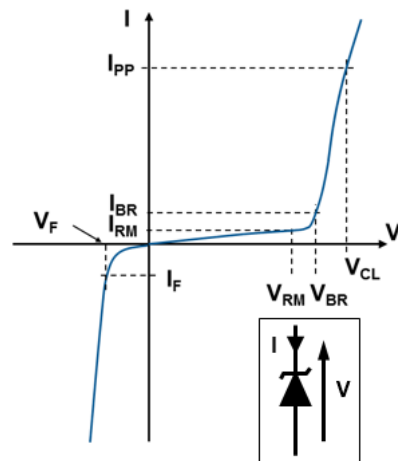
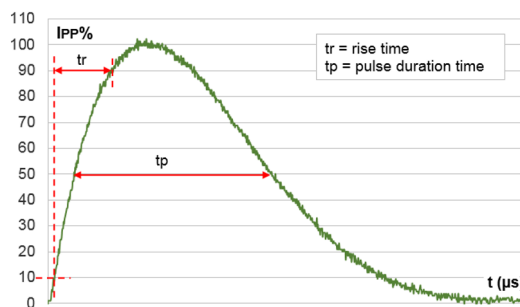
# 1 Characteristics

**Table 1. Absolute maximum ratings ( $T_{amb} = 25\text{ }^{\circ}\text{C}$ )**

Symbol	Parameter	Value	Unit	
$V_{PP}$	Peak pulse voltage	IEC 61000-4-2 (C = 150 pF, R = 330 $\Omega$ )	kV	
		Contact discharge		30
		Air discharge		30
$P_{PP}$	Peak pulse power dissipation	10/1000 $\mu\text{s}$ , $T_j$ initial = $T_{amb}$	600	W
$T_{stg}$	Storage temperature range		-65 to +175	$^{\circ}\text{C}$
$T_j$	Operating junction temperature range		-55 to +175	$^{\circ}\text{C}$
$T_L$	Maximum lead temperature for soldering during 10 s		260	$^{\circ}\text{C}$

**Figure 1. Electrical characteristics - parameter definitions**

- $V_{RM}$  Maximum stand-off voltage
- $I_{RM}$  Maximum leakage current @  $V_{RM}$
- $V_R$  Stand-off voltage
- $I_R$  Leakage current @  $V_R$
- $V_{BR}$  Breakdown voltage @  $I_{BR}$
- $I_{BR}$  Breakdown current
- $V_{CL}$  Clamping voltage @  $I_{PP}$
- $I_{PP}$  Peak pulse current
- $R_D$  Dynamic resistance
- $V_F$  Forward voltage drop @  $I_F$
- $I_F$  Forward current
- $\alpha T$  Voltage temperature coefficient


**Figure 2. Pulse definition for electrical characteristics**


**Table 2. Electrical characteristics - parameter values (T<sub>amb</sub> = 25 °C, unless otherwise specified)**

Type	I <sub>RM</sub> max at V <sub>RM</sub>			V <sub>BR</sub> at I <sub>BR</sub> <sup>(1)</sup>				10 / 1000 μs			8 / 20μs			αT
								V <sub>CL</sub> <sup>(2)(3)</sup>	I <sub>PP</sub> <sup>(4)</sup>	R <sub>D</sub>	V <sub>CL</sub> <sup>(2)(3)</sup>	I <sub>PP</sub> <sup>(4)</sup>	R <sub>D</sub>	
	25 °C	85 °C		Min.	Typ.	Max.		Max.		Max.	Max.		Max.	
	μA		V	V			mA	V	A	Ω	V	A	Ω	10 <sup>-4</sup> /°C
SMB6F5.0A	20	50	5.0	6.4	6.74	7.1	10	9.2	68	0.031	13.4	298	0.021	5.7
SMB6F6.0A	20	50	6.0	6.7	7.05	7.4	10	10.3	61	0.048	13.7	290	0.022	5.9
SMB6F6.5A	20	50	6.5	7.2	7.58	8	10	11.2	56	0.057	14.5	276	0.024	6.1
SMB6F8.5A	20	50	8.5	9.4	9.9	10.4	1	14.4	41.7	0.096	19.5	205	0.044	7.3
SMB6F10A	0.2	1	10	11.1	11.7	12.3	1	17	37	0.127	21.7	184	0.051	7.8
SMB6F11A	0.2	1	11	12.3	13	13.7	1	18	33.8	0.127	24.2	1665	0.064	8.1
SMB6F12A	0.2	1	12	13.3	14	14.7	1	19.9	31	0.168	25.3	157	0.068	8.3
SMB6F13A	0.2	1	13	14.4	15.2	16	1	21.5	29	0.190	27.2	147	0.076	8.4
SMB6F14A	0.2	1	14	15.7	16.5	17.3	1	23.1	26	0.223	29	136	0.086	8.6
SMB6F15A	0.2	1	15	16.7	17.6	18.5	1	24.4	25.1	0.235	32.5	123	0.114	8.8
SMB6F16A	0.2	1	16	17.9	18.8	19.8	1	26	23.1	0.268	34.7	115	0.130	9.0
SMB6F18A	0.2	1	18	20	21.1	22.2	1	29.2	21.5	0.326	39.3	102	0.168	9.2
SMB6F20A	0.2	1	20	22.2	23.4	24.6	1	32.4	19.4	0.402	42.8	93	0.196	9.4
SMB6F22A	0.2	1	22	24.4	25.7	27	1	35.5	17.7	0.480	48.3	83	0.257	9.6
SMB6F23A	0.2	1	23	25.7	27	28.4	1	37.8	16.4	0.573	49.2	81	0.257	9.6
SMB6F24A	0.2	1	24	26.7	28.1	29.5	1	38.9	16	0.588	50	80	0.256	9.6
SMB6F26A	0.2	1	26	28.9	30.4	31.9	1	42.1	14.9	0.685	53.5	75	0.288	9.7
SMB6F28A	0.2	1	28	31.1	32.7	34.3	1	45.4	13.8	0.804	59	68	0.363	9.8
SMB6F30A	0.2	1	30	33.2	35	36.8	1	48.4	13	0.885	64.3	62	0.442	9.9
SMB6F31A	0.2	1	31	34.2	36	37.8	1	50.2	12.3	1.01	65	61	0.45	9.9
SMB6F33A	0.2	1	33	36.7	38.6	40.5	1	53.3	11.8	1.08	69.7	57	0.512	10
SMB6F36A	0.2	1	36	40	42.1	44.2	1	58.1	10.3	1.35	76	52	0.612	10
SMB6F40A	0.2	1	40	44.4	46.7	49	1	64.5	9.7	1.60	84	48	0.729	10.1
SMB6F48A	0.2	1	48	53.2	56	58.8	1	77.4	8.1	2.28	100	40	1.03	10.3
SMB6F58A	0.2	1	58	64.6	68	71.4	1	93.6	6.7	3.34	121	33	1.51	10.4
SMB6F64A	0.2	1	64	71.1	74.8	78.6	1	103	5.8	4.17	134	30	1.84	10.5
SMB6F70A	0.2	1	70	77.9	82	86.1	1	113	5.5	4.91	146	27	2.22	10.5
SMB6F85A	0.2	1	85	95	100	105	1	137	4.6	7.17	178	22.5	3.29	10.6
SMB6F100A	0.2	1	100	111	117	123	1	162	3.8	10.3	212	19	4.68	10.7
SMB6F130A	0.2	1	130	144	152	160	1	209	3	16.3	265	15	7	10.8
SMB6F154A	0.2	1	154	171	180	189	1	246	2.4	23.8	317	12.6	10.2	10.8
SMB6F170A	0.2	1	170	190	200	210	1	275	2.2	30	353	11.3	12.7	10.8
SMB6F188A	0.2	1	188	209	220	231	1	328	2	48.5	388	10.3	15.2	10.8

1. To calculate V<sub>BR</sub> versus T<sub>j</sub>: V<sub>BR</sub> at T<sub>j</sub> = V<sub>BR</sub> at 25 °C x (1 + αT x (T<sub>j</sub> - 25))

2. To calculate V<sub>CL</sub> versus T<sub>j</sub>: V<sub>CL</sub> at T<sub>j</sub> = V<sub>CL</sub> at 25 °C x (1 + αT x (T<sub>j</sub> - 25))

3. To calculate V<sub>CL</sub> max versus I<sub>PPappli</sub>: V<sub>CL</sub>max = V<sub>BR</sub> max + RD x I<sub>PPappli</sub>

4. Surge capability given for both directions

1.1 Characteristics (curves)

Figure 3. Maximum peak power dissipation versus initial junction temperature

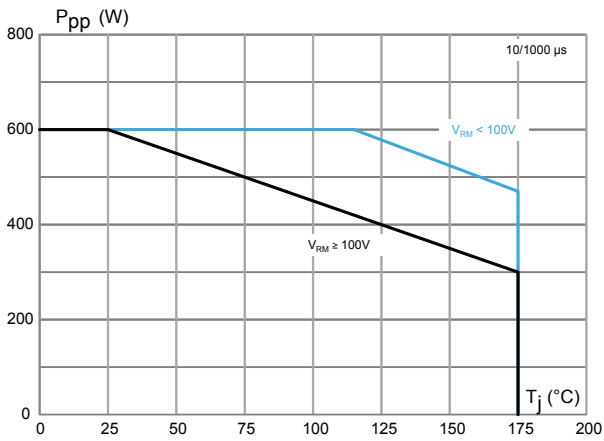


Figure 4. Maximum peak pulse power versus exponential pulse duration

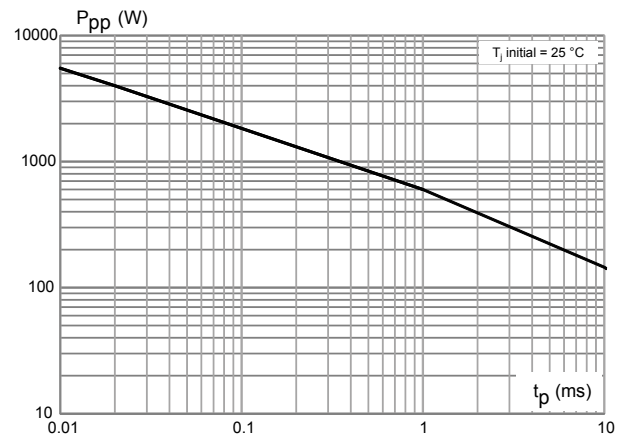


Figure 5. Maximum peak pulse current versus clamping voltage

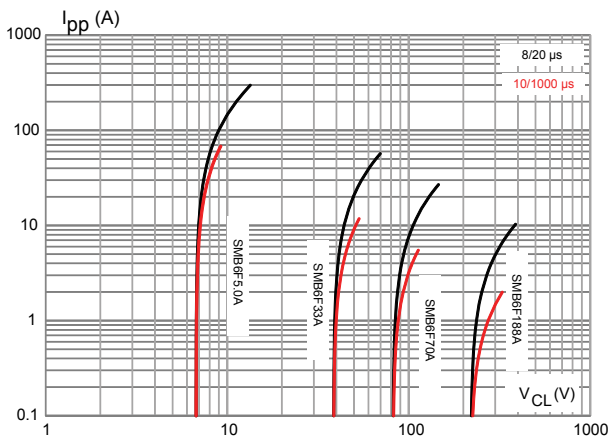
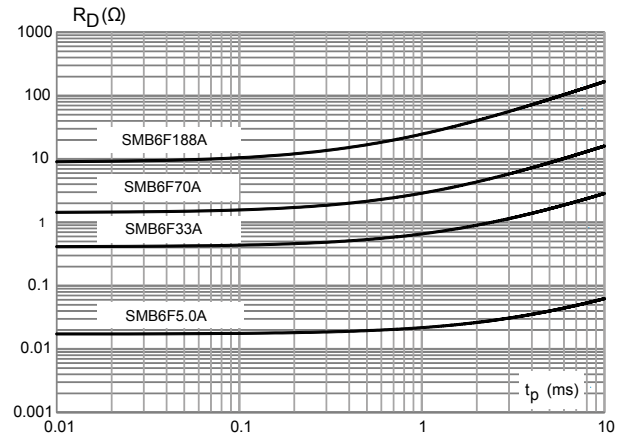
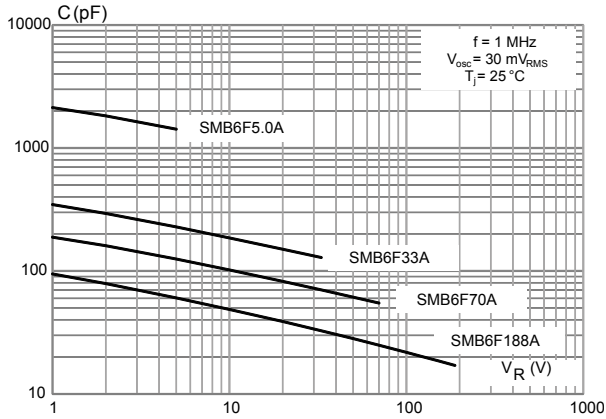


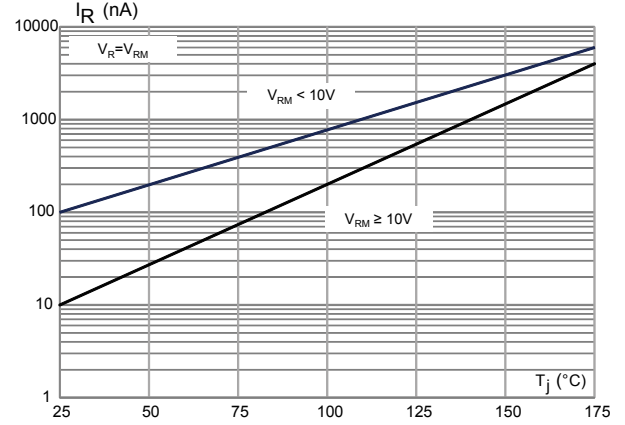
Figure 6. Dynamic resistance versus pulse duration



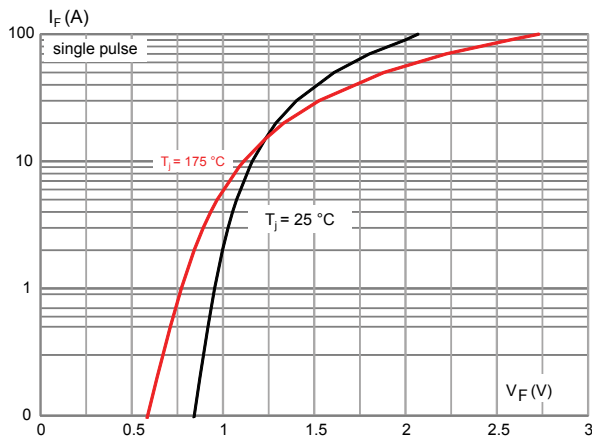
**Figure 7. Junction capacitance versus reverse applied voltage (unidirectional types)**



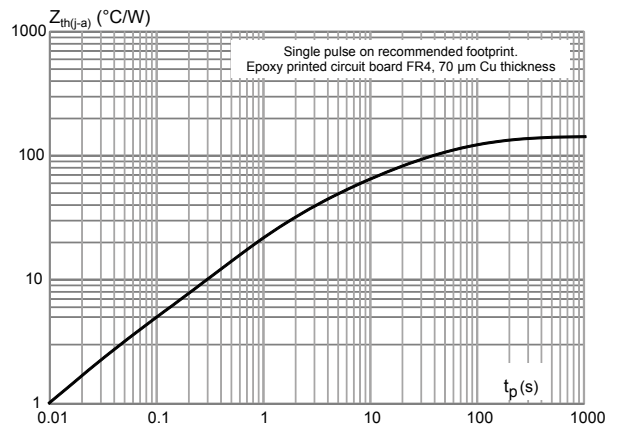
**Figure 8. Leakage current versus junction temperature**



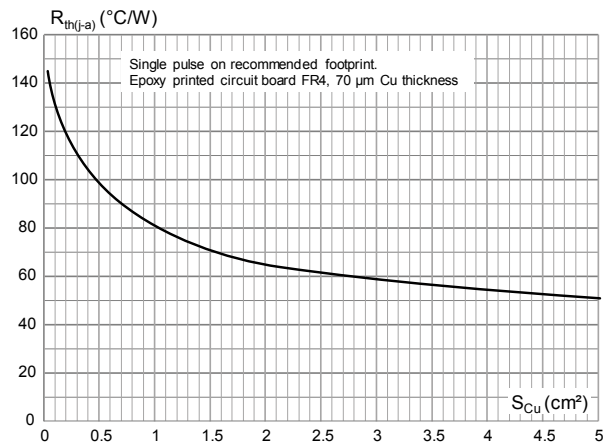
**Figure 9. Peak forward voltage drop versus peak forward current**



**Figure 10. Thermal impedance junction to ambient versus pulse duration**



**Figure 11. Thermal resistance junction to ambient versus copper area under each lead (SMB Flat)**

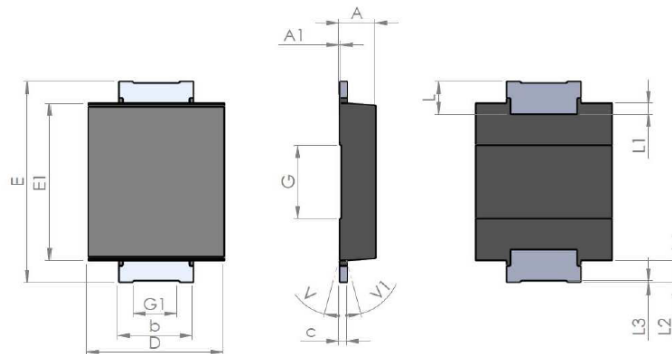


## 2 Package information

In order to meet environmental requirements, ST offers these devices in different grades of **ECOPACK** packages, depending on their level of environmental compliance. ECOPACK specifications, grade definitions and product status are available at: [www.st.com](http://www.st.com). ECOPACK is an ST trademark.

### 2.1 SMB Flat package information

**Figure 12. SMB Flat package outline**

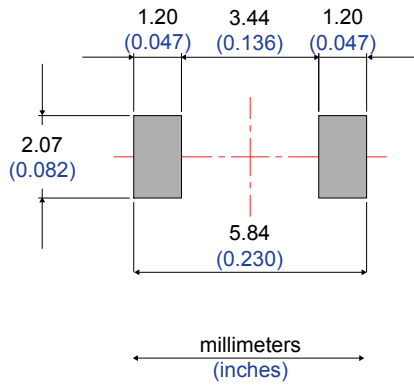


**Table 3. SMB Flat mechanical data**

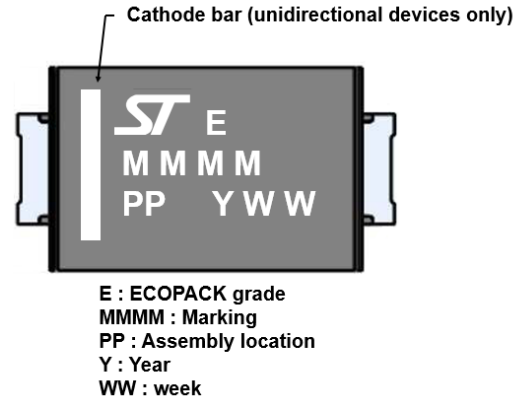
Ref.	Dimensions					
	Millimeters			Inches <sup>(1)</sup>		
	Min.	Typ.	Max.	Min.	Typ.	Max.
A	0.90		1.10	0.035		0.044
A1		0.05			0.002	
b	1.95		2.20	0.076		0.087
c	0.15		0.40	0.005		0.016
D	3.30		3.95	0.129		0.156
E	5.20		5.60	0.204		0.221
E1	4.05		4.60	0.159		0.182
G		2.00			0.079	
G1		1.20			0.047	
L	0.75		1.20	0.029		0.048
L1		0.30			0.012	
L2		0.60			0.024	
L3	0.02			0.000		
V			8°			8°
V1			8°			8°

1. Values in inches are converted from mm and rounded to 3 decimal digits.

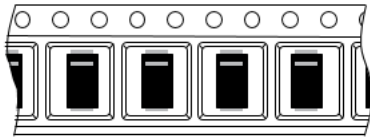
**Figure 13. Footprint recommendations, dimensions in mm (inches)**



**Figure 14. Marking layout (refer to ordering information table for marking)**

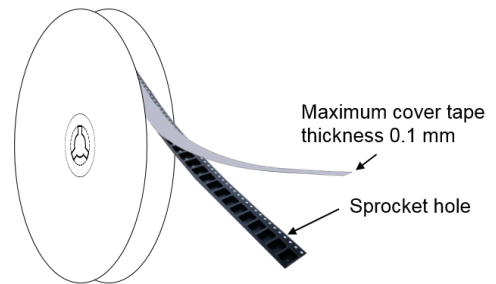


**Figure 15. Package orientation in reel**

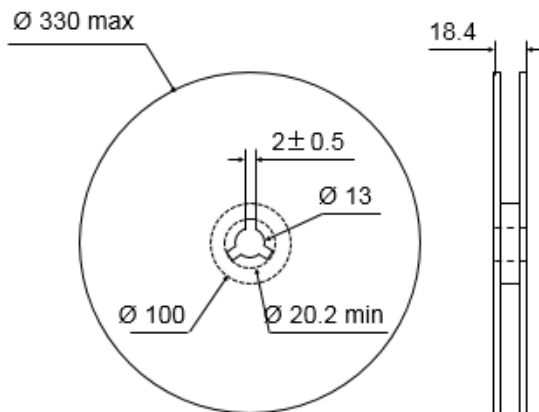


Taped according to EIA-481  
Note: Pocket dimensions are not on scale  
Pocket shape may vary depending on package  
On bidirectional devices, marking and logo may be not always in the same direction

**Figure 16. Tape and reel orientation**



**Figure 17. Reel dimensions (mm)**



**Figure 18. Inner box dimensions (mm)**

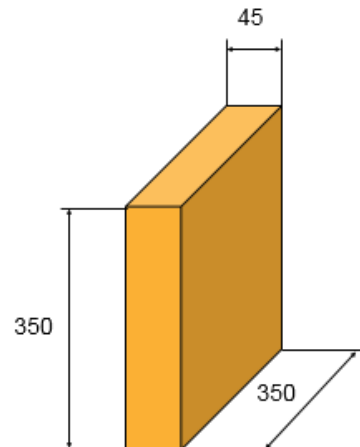
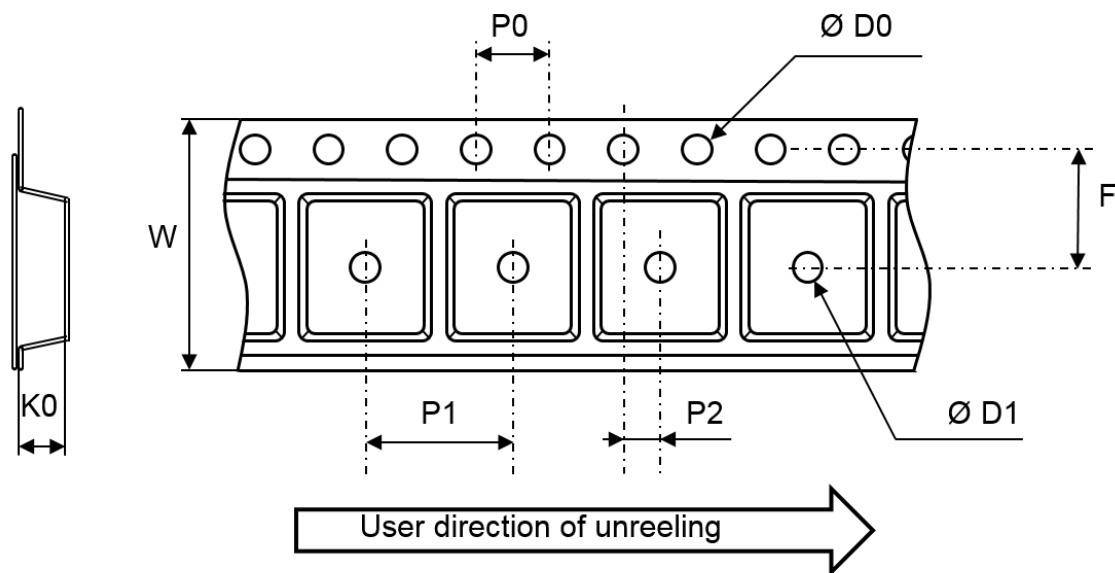


Figure 19. Tape and reel outline



Note: Pocket dimensions are not on scale  
Pocket shape may vary depending on package

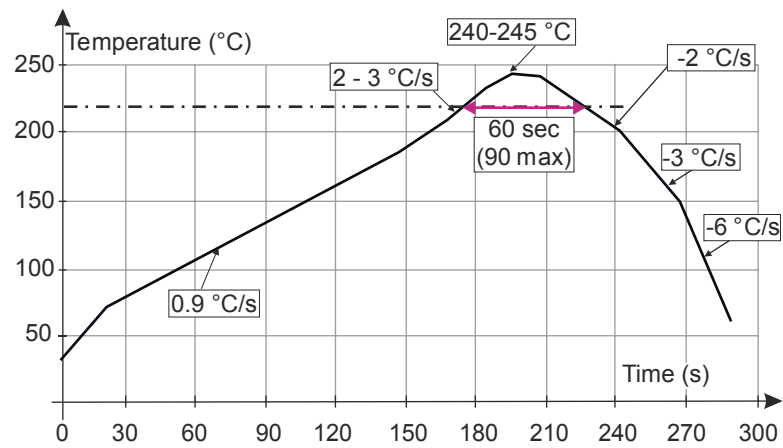
Table 4. Tape and reel mechanical data

Ref.	Dimensions		
	Millimeters		
	Min.	Typ.	Max.
ØD0	1.45	1.50	1.55
ØD1	1.5		
F	5.4	5.5	5.6
K0	1.2	1.3	1.4
P0	3.9	4.0	4.1
P1	7.9	8.0	8.1
P2	1.9	2.0	2.1
W	11.7	12.0	12.3



## 2.2 Reflow profile

Figure 20. ST ECOPACK recommended soldering reflow profile for PCB mounting



Note: Minimize air convection currents in the reflow oven to avoid component movement. Maximum soldering profile corresponds to the latest IPC/JEDEC J-STD-020.

### 3 Ordering information

Figure 21. Ordering information scheme

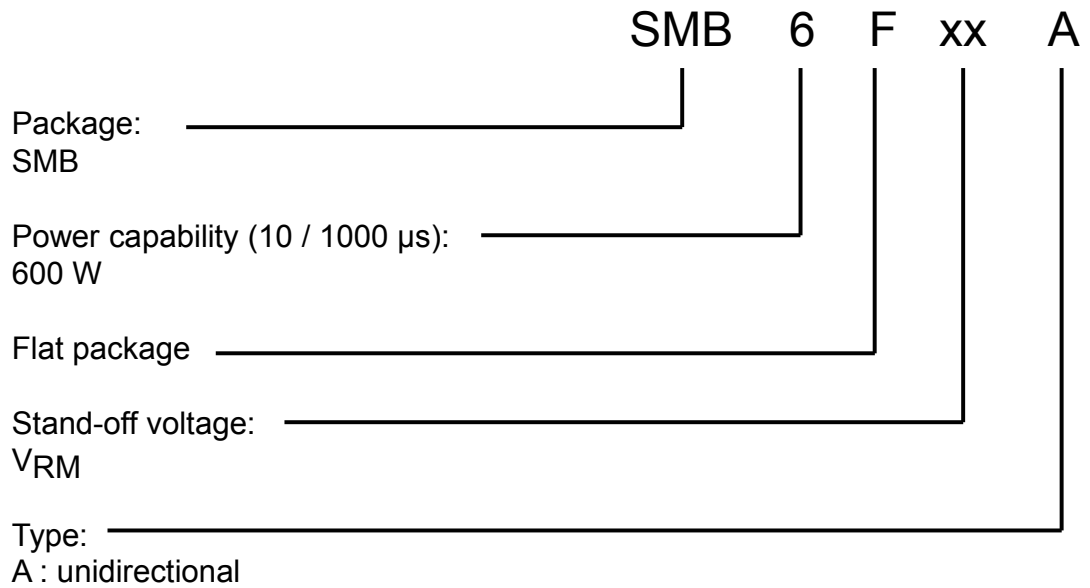


Table 5. Ordering information

Order code	Marking	Package	Weight	Base qty.	Delivery mode
SMB6FxxA	See <a href="#">Table 6. Marking.</a>	SMB Flat	56 mg	5000	Tape and reel

**Table 6. Marking**

Order code	Marking
SMB6F5.0A	7AI
SMB6F6.0A	7AK
SMB6F6.5A	7AL
SMB6F8.5A	7AP
SMB6F10A	7AS
SMB6F11A	7AU
SMB6F12A	7AW
SMB6F13A	7AY
SMB6F14A	7BA
SMB6F15A	7BC
SMB6F16A	7BE
SMB6F18A	7BI
SMB6F20A	7BM
SMB6F22A	7BO
SMB6F23A	7BP
SMB6F24A	7BQ
SMB6F26A	7BS
SMB6F28A	7BU
SMB6F30A	7BW
SMB6F31A	7BX
SMB6F33A	7BZ
SMB6F36A	7CC
SMB6F40A	7CG
SMB6F48A	7CO
SMB6F58A	7CY
SMB6F64A	7DE
SMB6F70A	7DK
SMB6F85A	7DZ
SMB6F100A	7EO
SMB6F130A	7FS
SMB6F154A	7GQ
SMB6F170A	7HG
SMB6F188A	7HY

## Revision history

**Table 7. Document revision history**

Date	Version	Changes
21-Jan-2019	1	Initial release.
19-Feb-2019	2	Updated link syntax.
16-May-2019	3	Updated <a href="#">Table 1</a> . Absolute maximum ratings ( $T_{amb} = 25\text{ }^{\circ}\text{C}$ ).
14-Oct-2019	4	Added 64 V device.

**IMPORTANT NOTICE – PLEASE READ CAREFULLY**

STMicroelectronics NV and its subsidiaries (“ST”) reserve the right to make changes, corrections, enhancements, modifications, and improvements to ST products and/or to this document at any time without notice. Purchasers should obtain the latest relevant information on ST products before placing orders. ST products are sold pursuant to ST’s terms and conditions of sale in place at the time of order acknowledgement.

Purchasers are solely responsible for the choice, selection, and use of ST products and ST assumes no liability for application assistance or the design of Purchasers’ products.

No license, express or implied, to any intellectual property right is granted by ST herein.

Resale of ST products with provisions different from the information set forth herein shall void any warranty granted by ST for such product.

ST and the ST logo are trademarks of ST. For additional information about ST trademarks, please refer to [www.st.com/trademarks](http://www.st.com/trademarks). All other product or service names are the property of their respective owners.

Information in this document supersedes and replaces information previously supplied in any prior versions of this document.

© 2019 STMicroelectronics – All rights reserved