

N-channel 700 V, 1.3 Ω typ., 5 A Power MOSFET in a DPAK package

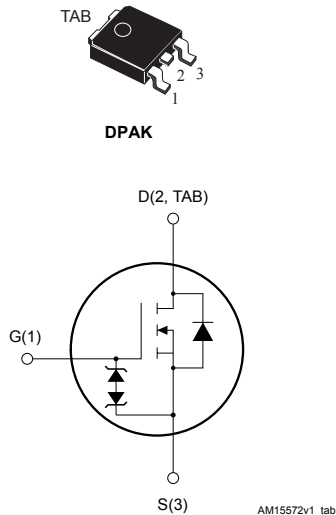

Features

Order code	V_{DS}	$R_{DS(on)}$ max.	I_D
STD70R1K3S	700 V	1.4 Ω	5 A

- Reduced switching losses
- Lower $R_{DS(on)}$ per area vs previous generation
- Low gate input resistance
- 100% avalanche tested
- Zener-protected

Applications

- Switching applications

Description

This device is an high voltage N-channel Power MOSFET. This product offers improved on-resistance, low gate charge, high dv/dt capability and excellent avalanche characteristics.



Product status link

[STD70R1K3S](#)

Product summary

Order code	STD70R1K3S
Marking	70R1K3S
Package	DPAK
Packing	Tape and reel

1 Electrical ratings

Table 1. Absolute maximum ratings

Symbol	Parameter	Value	Unit
V_{GS}	Gate-source voltage	± 25	V
I_D	Drain current (continuous) at $T_C = 25\text{ }^\circ\text{C}$	5	A
	Drain current (continuous) at $T_C = 100\text{ }^\circ\text{C}$	3.15	
$I_{DM}^{(1)}$	Drain current (pulsed)	8.5	A
P_{TOT}	Total power dissipation at $T_C = 25\text{ }^\circ\text{C}$	77	W
$dv/dt^{(2)}$	Peak diode recovery voltage slope	5	V/ns
$di/dt^{(2)}$	Peak diode recovery current slope	100	A/ μs
$dv/dt^{(3)}$	MOSFET dv/dt ruggedness	50	V/ns
T_J	Operating junction temperature range	-55 to 150	$^\circ\text{C}$
T_{stg}	Storage temperature range		

1. Pulse width limited by safe operating area.
2. $I_{SD} \leq 5\text{ A}$, $V_{DS\text{ peak}} < V_{(BR)DSS}$, $V_{DD} = 100\text{ V}$.
3. $V_{DS} \leq 560\text{ V}$.

Table 2. Thermal data

Symbol	Parameter	Value	Unit
$R_{thj-case}$	Thermal resistance junction-case	1.62	$^\circ\text{C/W}$
$R_{thj-pcb}^{(1)}$	Thermal resistance junction-ambient	50	$^\circ\text{C/W}$

1. When mounted on an 1-inch² FR-4, 2 Oz copper board.

Table 3. Avalanche characteristics

Symbol	Parameter	Value	Unit
I_{AR}	Avalanche current, repetitive or not repetitive (pulse width limited by $T_J\text{ max}$)	1	A
E_{AS}	Single pulse avalanche energy (starting $T_J = 25\text{ }^\circ\text{C}$, $I_D = I_{AR}$, $V_{DD} = 50\text{ V}$)	90	mJ

2 Electrical characteristics

$T_C = 25\text{ °C}$ unless otherwise specified

Table 4. On/off-state

Symbol	Parameter	Test conditions	Min.	Typ.	Max.	Unit
$V_{(BR)DSS}$	Drain-source breakdown voltage	$V_{GS} = 0\text{ V}$, $I_D = 1\text{ mA}$	700			V
I_{DSS}	Zero gate voltage drain current	$V_{GS} = 0\text{ V}$, $V_{DS} = 700\text{ V}$			1	μA
		$V_{GS} = 0\text{ V}$, $V_{DS} = 700\text{ V}$, $T_C = 125\text{ °C}^{(1)}$			100	μA
I_{GSS}	Gate-body leakage current	$V_{DS} = 0\text{ V}$, $V_{GS} = \pm 25\text{ V}$			5	μA
$V_{GS(th)}$	Gate threshold voltage	$V_{DS} = V_{GS}$, $I_D = 250\text{ }\mu\text{A}$	2.25	3.00	3.75	V
$R_{DS(on)}$	Static drain-source on-resistance	$V_{GS} = 10\text{ V}$, $I_D = 1.75\text{ A}$		1.3	1.4	Ω

1. Defined by design, not subject to production test.

Table 5. Dynamic

Symbol	Parameter	Test conditions	Min.	Typ.	Max.	Unit
C_{iss}	Input capacitance	$V_{DS} = 100\text{ V}$, $f = 1\text{ MHz}$, $V_{GS} = 0\text{ V}$	-	175	-	pF
C_{oss}	Output capacitance		-	13	-	pF
C_{rss}	Reverse transfer capacitance		-	0.43	-	pF
$C_{oss\text{ eq.}}^{(1)}$	Equivalent output capacitance	$V_{DS} = 0\text{ to }560\text{ V}$, $V_{GS} = 0\text{ V}$	-	70	-	pF
R_G	Intrinsic gate resistance	$f = 1\text{ MHz}$ open drain	-	5	-	Ω
Q_g	Total gate charge	$V_{DD} = 560\text{ V}$, $I_D = 3.5\text{ A}$, $V_{GS} = 0\text{ to }10\text{ V}$ (See Figure 14. Test circuit for gate charge behavior)	-	4.1	-	nC
Q_{gs}	Gate-source charge		-	0.9	-	nC
Q_{gd}	Gate-drain charge		-	1.6	-	nC

1. $C_{oss\text{ eq.}}$ is defined as a constant equivalent capacitance giving the same charging time as C_{oss} when V_{DS} increases from 0 to 80% V_{DSS} .

Table 6. Switching times

Symbol	Parameter	Test conditions	Min.	Typ.	Max.	Unit
$t_{d(on)}$	Turn-on delay time	$V_{DD} = 350\text{ V}$, $I_D = 1.75\text{ A}$, $R_G = 4.7\text{ }\Omega$, $V_{GS} = 10\text{ V}$	-	7	-	ns
t_r	Rise time		-	6.5	-	ns
$t_{d(off)}$	Turn-off delay time	(See Figure 13. Test circuit for resistive load switching times and Figure 18. Switching time waveform)	-	18	-	ns
t_f	Fall time		-	20	-	ns

Table 7. Source-drain diode

Symbol	Parameter	Test conditions	Min.	Typ.	Max.	Unit
I_{SD}	Source-drain current		-		5	A
$I_{SDM}^{(1)}$	Source-drain current (pulsed)		-		8.5	A
$V_{SD}^{(2)}$	Forward on voltage	$I_{SD} = 5\text{ A}$, $V_{GS} = 0\text{ V}$	-		1.6	V
t_{rr}	Reverse recovery time	$I_{SD} = 3.5\text{ A}$, $di/dt = 100\text{ A}/\mu\text{s}$,	-	267		ns
Q_{rr}	Reverse recovery charge	$V_{DD} = 60\text{ V}$	-	1.78		μC
I_{RRM}	Reverse recovery current	(See Figure 15. Test circuit for inductive load switching and diode recovery times)	-	9.8		A
t_{rr}	Reverse recovery time	$I_{SD} = 3.5\text{ A}$, $di/dt = 100\text{ A}/\mu\text{s}$,	-	400		ns
Q_{rr}	Reverse recovery charge	$V_{DD} = 60\text{ V}$, $T_J = 150\text{ }^\circ\text{C}$	-	2.52		μC
I_{RRM}	Reverse recovery current	(See Figure 15. Test circuit for inductive load switching and diode recovery times)	-	8.5		A

1. Pulse width limited by safe operating area
2. Pulsed: pulse duration = 300 μs , duty cycle 1.5%

2.1 Electrical characteristics (curves)

Figure 1. Safe operating area

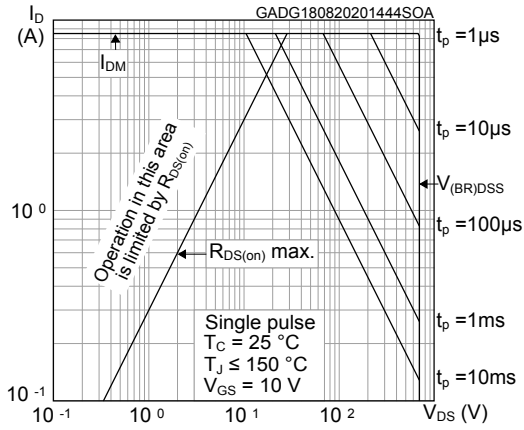

Figure 2. Maximum transient thermal impedance

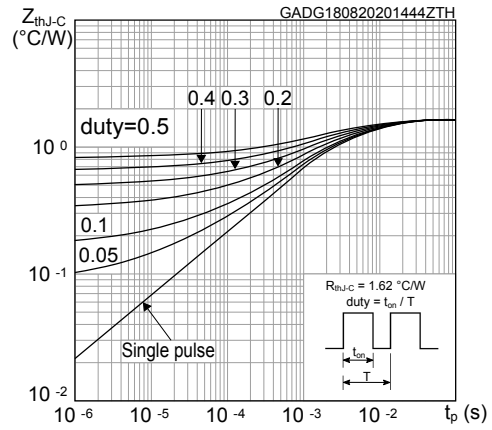

Figure 3. Typical output characteristics

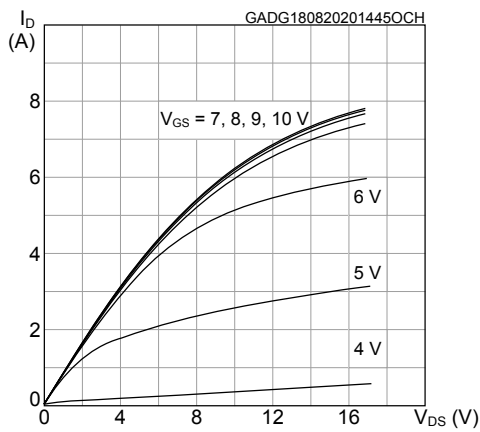

Figure 4. Typical transfer characteristics

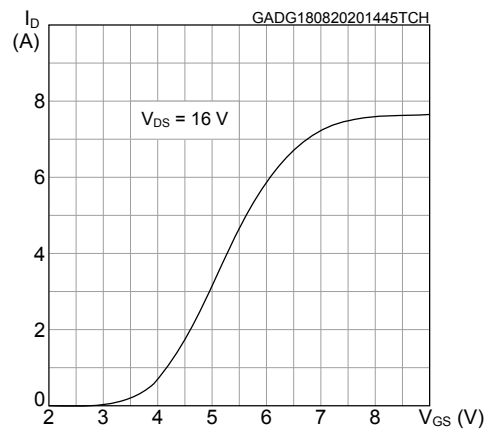

Figure 5. Typical gate charge characteristics

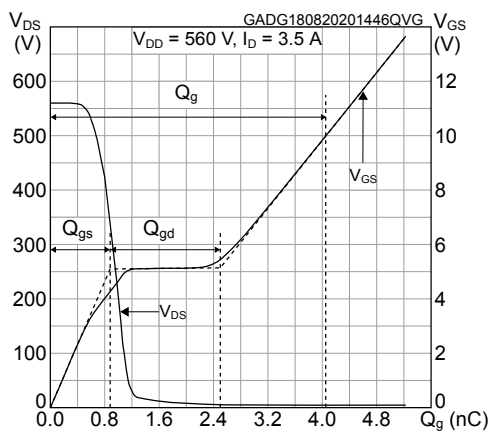

Figure 6. Typical drain-source on-resistance

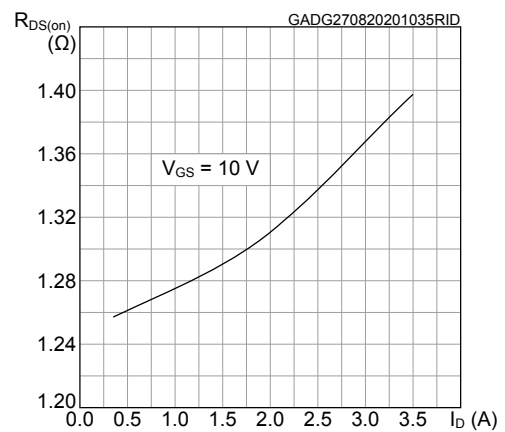

Figure 7. Typical capacitance characteristics

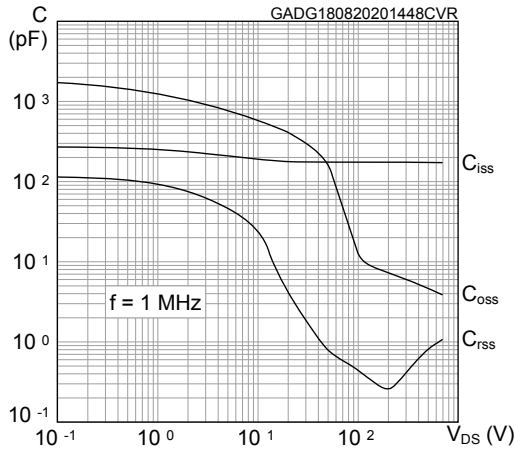

Figure 8. Normalized gate threshold vs temperature

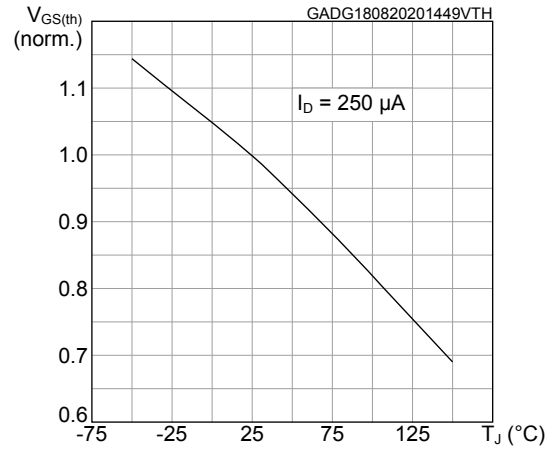

Figure 9. Normalized on-resistance vs temperature

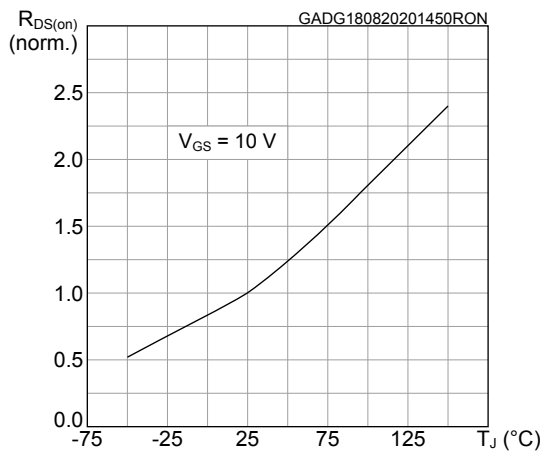

Figure 10. Normalized breakdown voltage vs temperature

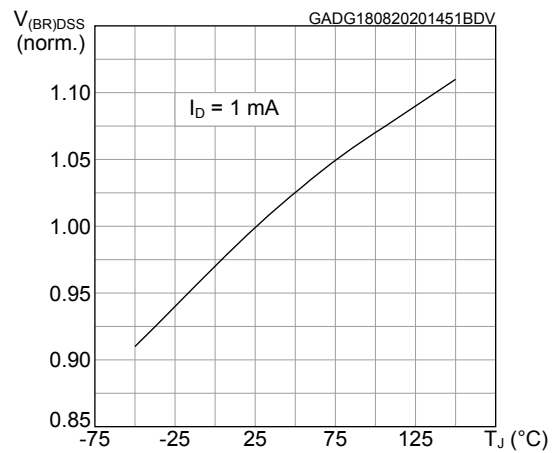

Figure 11. Typical output capacitance stored energy

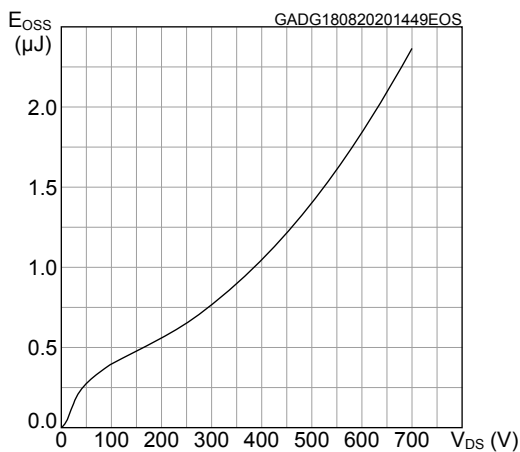
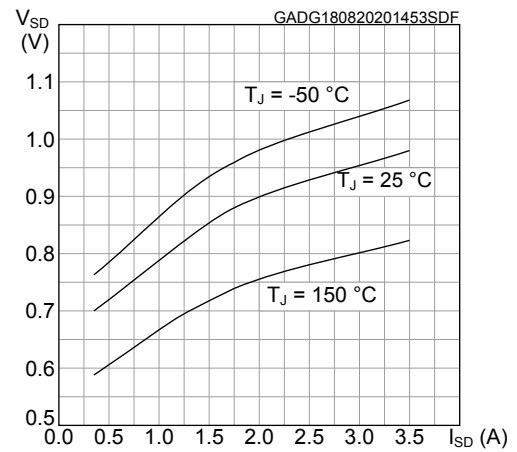
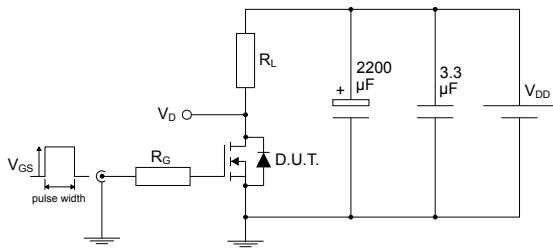

Figure 12. Typical reverse diode forward characteristics



3 Test circuits

Figure 13. Test circuit for resistive load switching times

AM01468v1

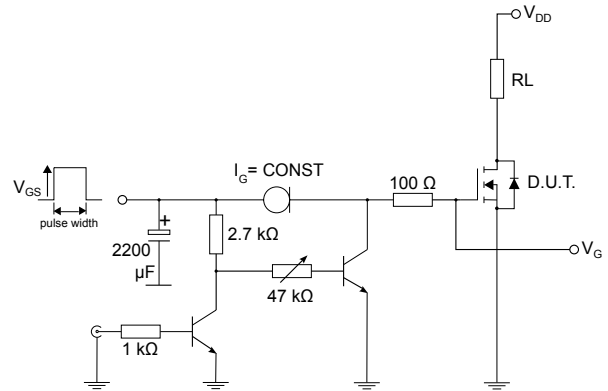
Figure 14. Test circuit for gate charge behavior

AM01469v10

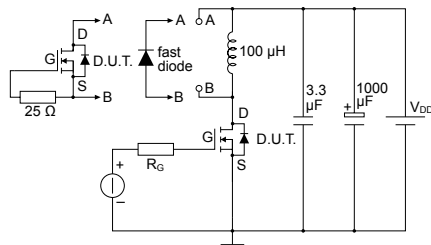
Figure 15. Test circuit for inductive load switching and diode recovery times

AM01470v1

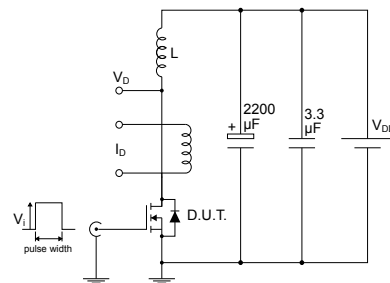
Figure 16. Unclamped inductive load test circuit

AM01471v1

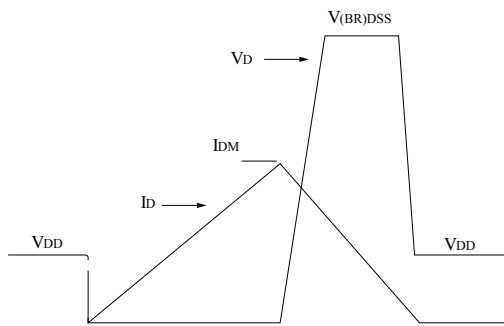
Figure 17. Unclamped inductive waveform

AM01472v1

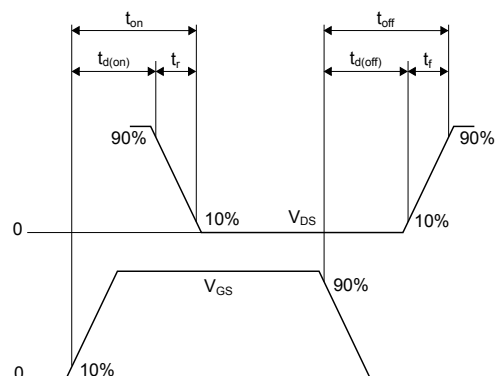
Figure 18. Switching time waveform

AM01473v1

4 Package information

In order to meet environmental requirements, ST offers these devices in different grades of **ECOPACK** packages, depending on their level of environmental compliance. ECOPACK specifications, grade definitions and product status are available at: www.st.com. ECOPACK is an ST trademark.

4.1 DPAK (TO-252) type C package information

Figure 19. DPAK (TO-252) type C package outline

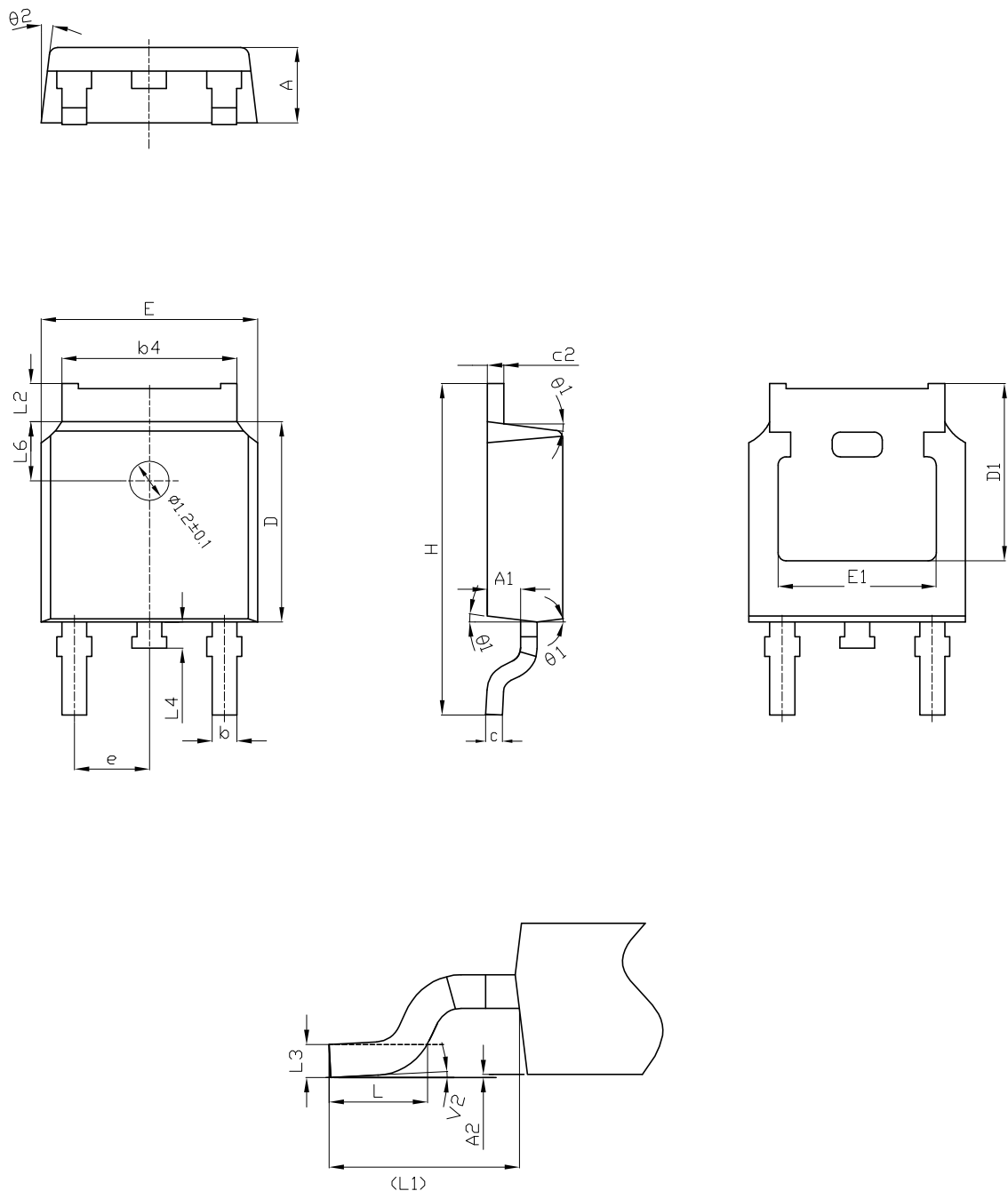

0068772_C_29

Table 8. DPAK (TO-252) type C mechanical data

Dim.	mm		
	Min.	Typ.	Max.
A	2.20	2.30	2.38
A1	0.90	1.01	1.10
A2	0.00		0.10
b	0.72		0.85
b4	5.13	5.33	5.46
c	0.47		0.60
c2	0.47		0.60
D	6.00	6.10	6.20
D1	5.25		
E	6.50	6.60	6.70
E1	4.70		
e	2.186	2.286	2.386
H	9.80	10.10	10.40
L	1.40	1.50	1.70
L1	2.90 REF		
L2	0.90		1.25
L3	0.51 BSC		
L4	0.60	0.80	1.00
L6	1.80 BSC		
θ1	5°	7°	9°
θ2	5°	7°	9°
V2	0°		8°

Figure 20. DPAK (TO-252) recommended footprint (dimensions are in mm)

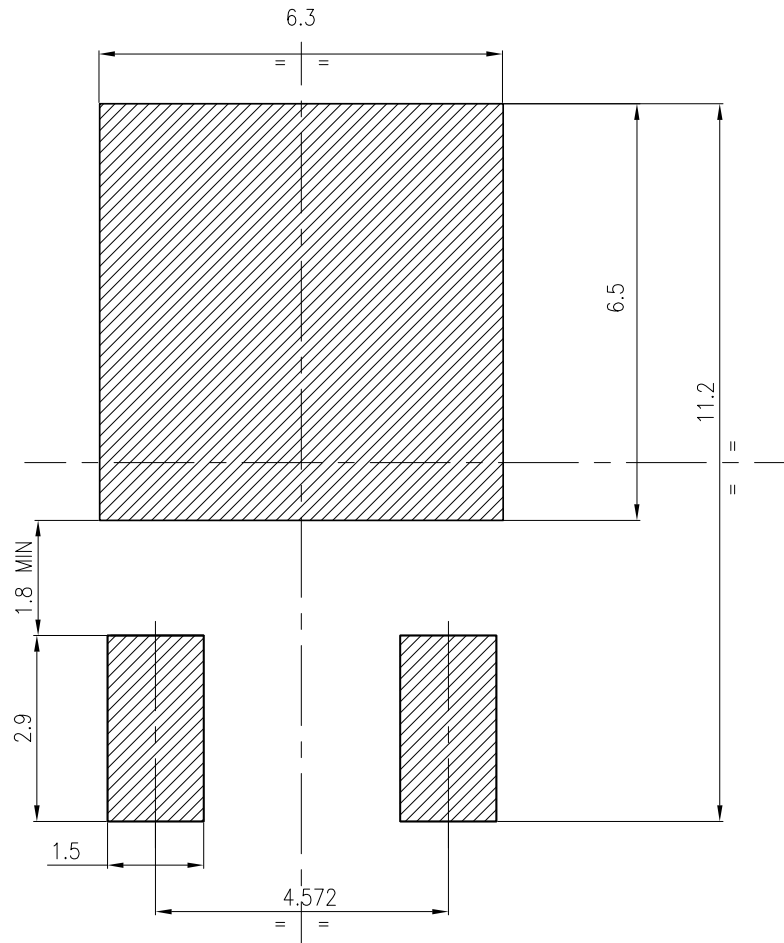

FP_0068772_29

4.2 DPAK (TO-252) packing information

Figure 21. DPAK (TO-252) tape outline

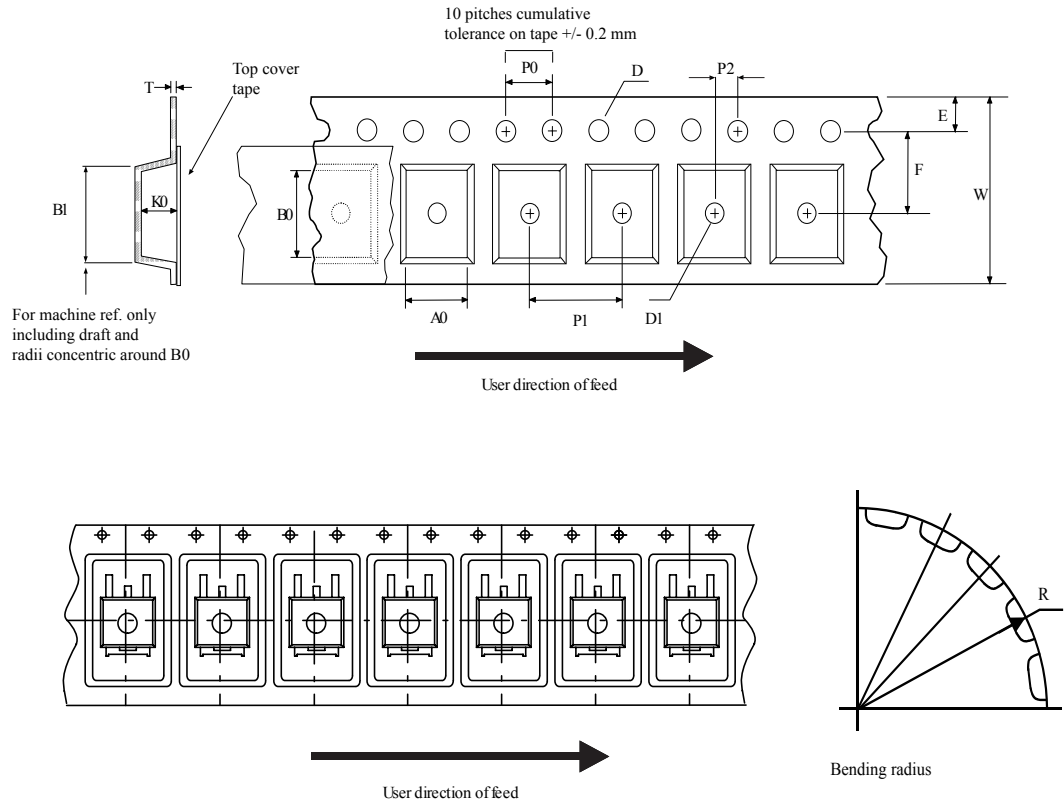

AM08852v1

Figure 22. DPAK (TO-252) reel outline

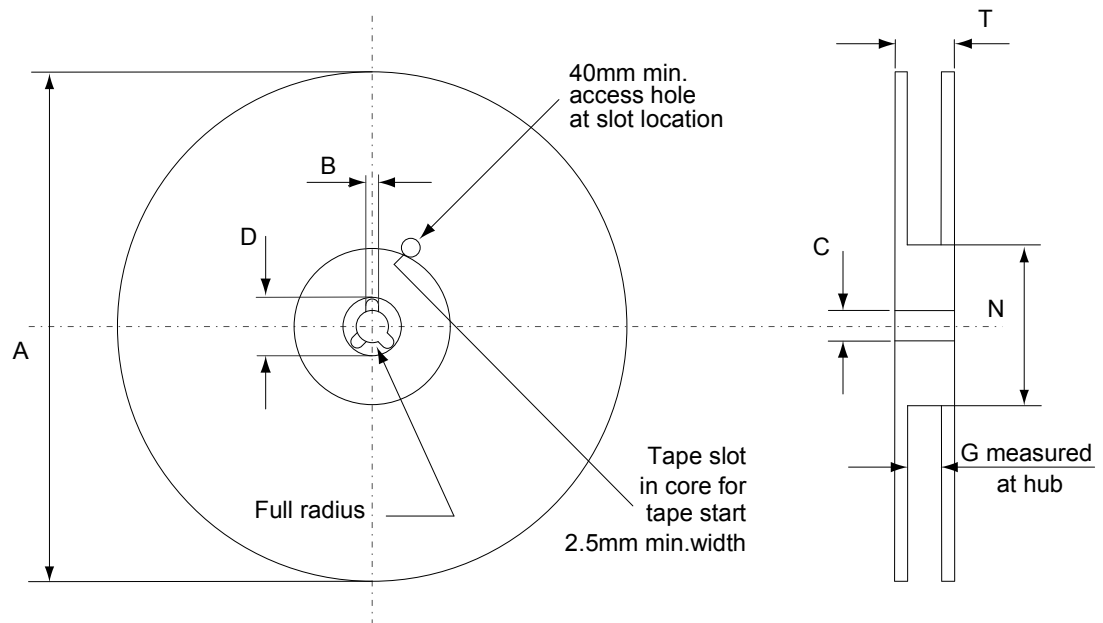

AM06038v1

Table 9. DPAK (TO-252) tape and reel mechanical data

Tape			Reel		
Dim.	mm		Dim.	mm	
	Min.	Max.		Min.	Max.
A0	6.8	7	A		330
B0	10.4	10.6	B	1.5	
B1		12.1	C	12.8	13.2
D	1.5	1.6	D	20.2	
D1	1.5		G	16.4	18.4
E	1.65	1.85	N	50	
F	7.4	7.6	T		22.4
K0	2.55	2.75			
P0	3.9	4.1	Base qty.		2500
P1	7.9	8.1	Bulk qty.		2500
P2	1.9	2.1			
R	40				
T	0.25	0.35			
W	15.7	16.3			

Revision history

Table 10. Document revision history

Date	Version	Changes
17-Dec-2019	1	Initial release.
03-Sep-2020	2	Updated Title and Features in cover page. Updated Section 1 Electrical ratings. Updated Section 2 Electrical characteristics. Added Section 2.1 Electrical characteristics (curves). Updated Figure 14. Test circuit for gate charge behavior. Updated Section 4 Package information.

Contents

1	Electrical ratings	2
2	Electrical characteristics	3
2.1	Electrical characteristics (curves)	5
3	Test circuits	7
4	Package information	8
4.1	DPAK (TO-252) type C package information	8
4.2	DPAK (TO-252) packing information	11
	Revision history	13

IMPORTANT NOTICE – PLEASE READ CAREFULLY

STMicroelectronics NV and its subsidiaries (“ST”) reserve the right to make changes, corrections, enhancements, modifications, and improvements to ST products and/or to this document at any time without notice. Purchasers should obtain the latest relevant information on ST products before placing orders. ST products are sold pursuant to ST’s terms and conditions of sale in place at the time of order acknowledgement.

Purchasers are solely responsible for the choice, selection, and use of ST products and ST assumes no liability for application assistance or the design of Purchasers’ products.

No license, express or implied, to any intellectual property right is granted by ST herein.

Resale of ST products with provisions different from the information set forth herein shall void any warranty granted by ST for such product.

ST and the ST logo are trademarks of ST. For additional information about ST trademarks, please refer to www.st.com/trademarks. All other product or service names are the property of their respective owners.

Information in this document supersedes and replaces information previously supplied in any prior versions of this document.

© 2020 STMicroelectronics – All rights reserved