



# STEVAL-TDR009V1

RF power amplifier demonstration board using: 2 x SD2932  
N-channel enhancement-mode lateral MOSFETs

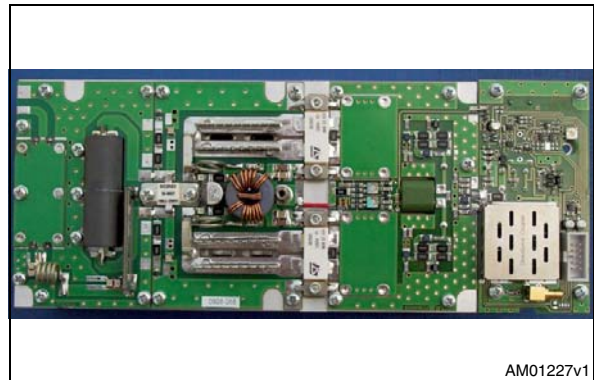
## Features

- Excellent thermal stability
- Frequency: 87.5 - 108 MHz
- Supply voltage: 48 V
- Output power: 650 W min.
- Gain: 19.5 dB min.
- Efficiency: 73 % min.
- Harmonics < - 36 dBc
- Gain flatness:  $\pm 0.5$  dB max

## Description

The STEVAL-TDR009V1 is a RF broadband power amplifier intended for FM broadcast radio transmitters over the band 87.5 to 108 MHz using 2 x SD2932 gold metallized N-channel MOS field-effect transistors.

STEVAL-TDR009V1 is designed in cooperation with InnovAction s.r.l in italy.



**Table 1. Device summary**

Order code
STEVAL-TDR009V1

# Contents

<b>1</b>	<b>Electrical data</b> .....	<b>3</b>
	1.1 Maximum ratings .....	3
<b>2</b>	<b>Electrical characteristics</b> .....	<b>3</b>
<b>3</b>	<b>Circuit schematic</b> .....	<b>4</b>
<b>4</b>	<b>Circuit layout and connections</b> .....	<b>7</b>
<b>5</b>	<b>Features include</b> .....	<b>8</b>
<b>6</b>	<b>SD2932 mounting recommendations</b> .....	<b>9</b>
	6.1 Mounting recommendations .....	9
	6.2 Mounting sequence .....	9
<b>7</b>	<b>Package mechanical data:</b> .....	<b>10</b>
<b>8</b>	<b>Revision history</b> .....	<b>12</b>

# 1 Electrical data

## 1.1 Maximum ratings

**Table 2. Absolute maximum ratings**

Symbol	Parameter	Value	Unit
P <sub>IN</sub>	Input power	15	W
P <sub>OUT</sub>	Output power	700	W
T <sub>STG</sub>	Storage temperature range	-20 to +70	°C
T <sub>C</sub>	Operating base plate temperature	0 to +70	°C
I <sub>DD</sub>	Drain current	22	A
P <sub>DISS</sub>	Power dissipation	400	W

## 2 Electrical characteristics

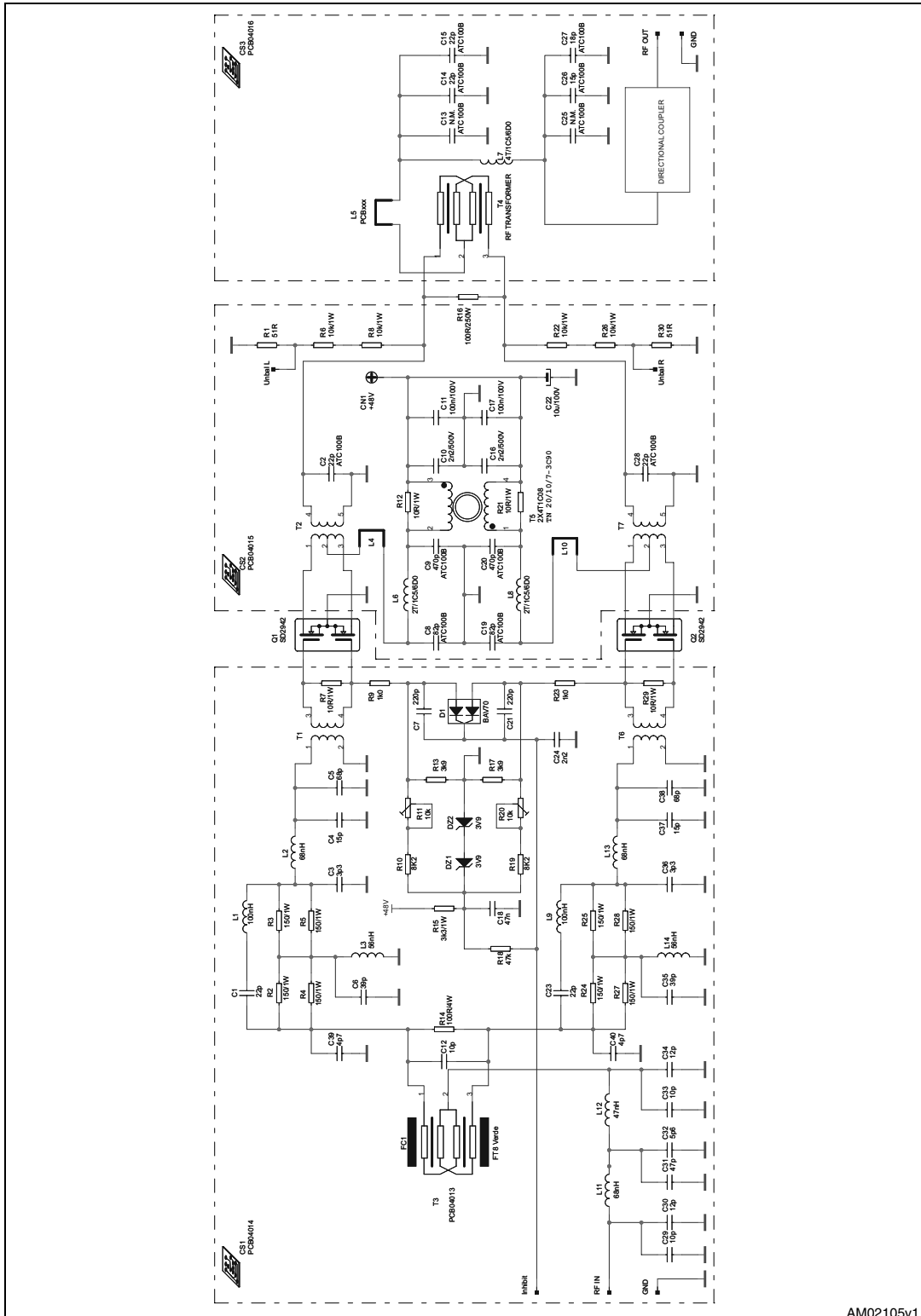
T<sub>A</sub> = +25 °C, V<sub>DD</sub> = 48 V, I<sub>dq</sub> = 2 x 200 mA

**Table 3. Electrical specification**

Symbol	Test conditions	Min	Typ	Max	Unit
Frequency	Frequency range	87.5		108	MHz
P <sub>OUT</sub>		650		700	W
Gain	P <sub>OUT</sub> = 650 W	20 ± 1.0			dB
ND	P <sub>OUT</sub> = 650 W	80			%
H2	2 <sup>nd</sup> harmonic @ P <sub>OUT</sub> = 650 W	-40			dBc
H3	3 <sup>rd</sup> harmonic @ P <sub>OUT</sub> = 650 W	-45			dBc
FL	gain flatness @ P <sub>OUT</sub> = 650 W			± 0.5	dB

### 3 Circuit schematic

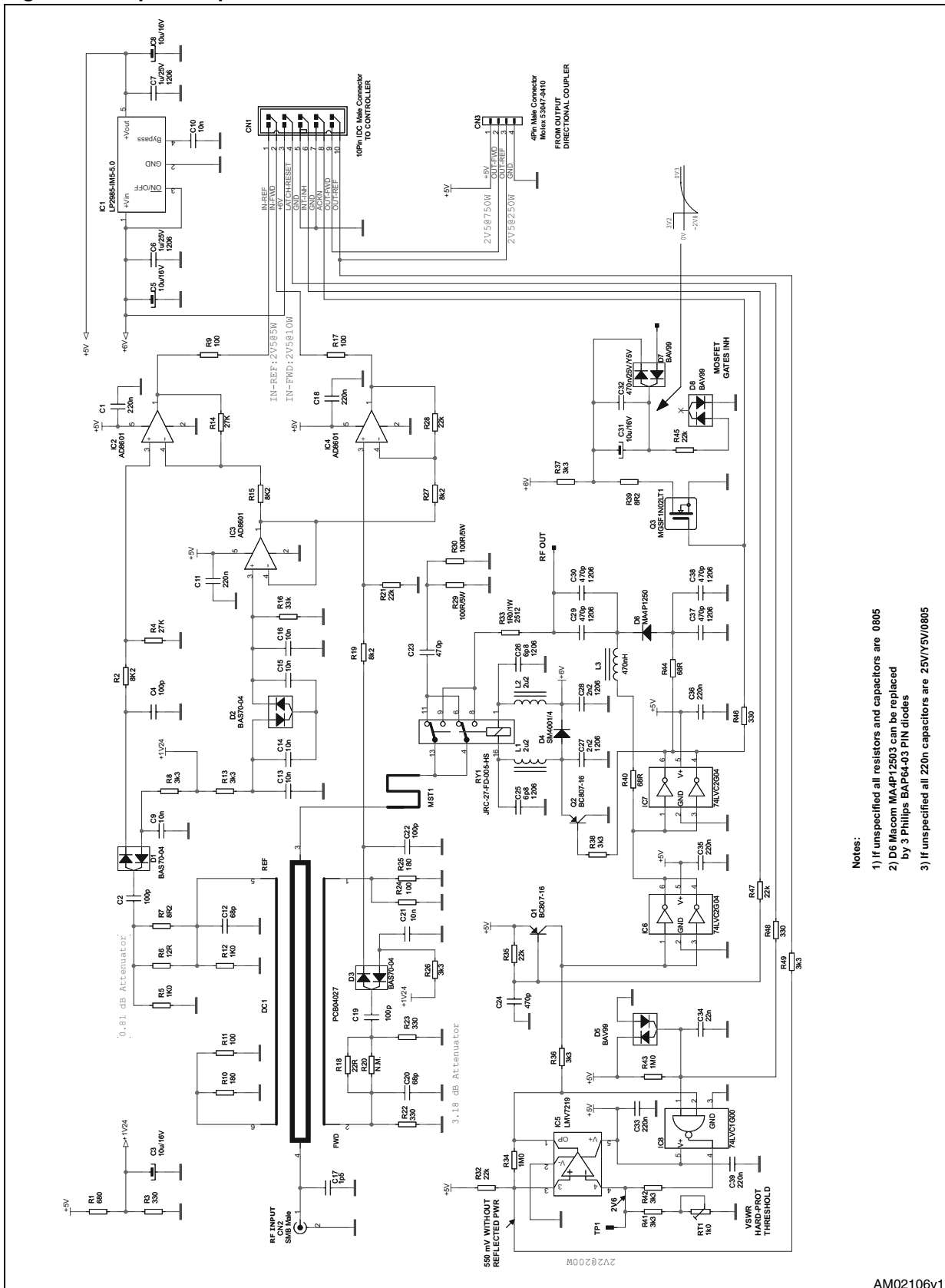
Figure 1. RF amplifier module



AM02105v1



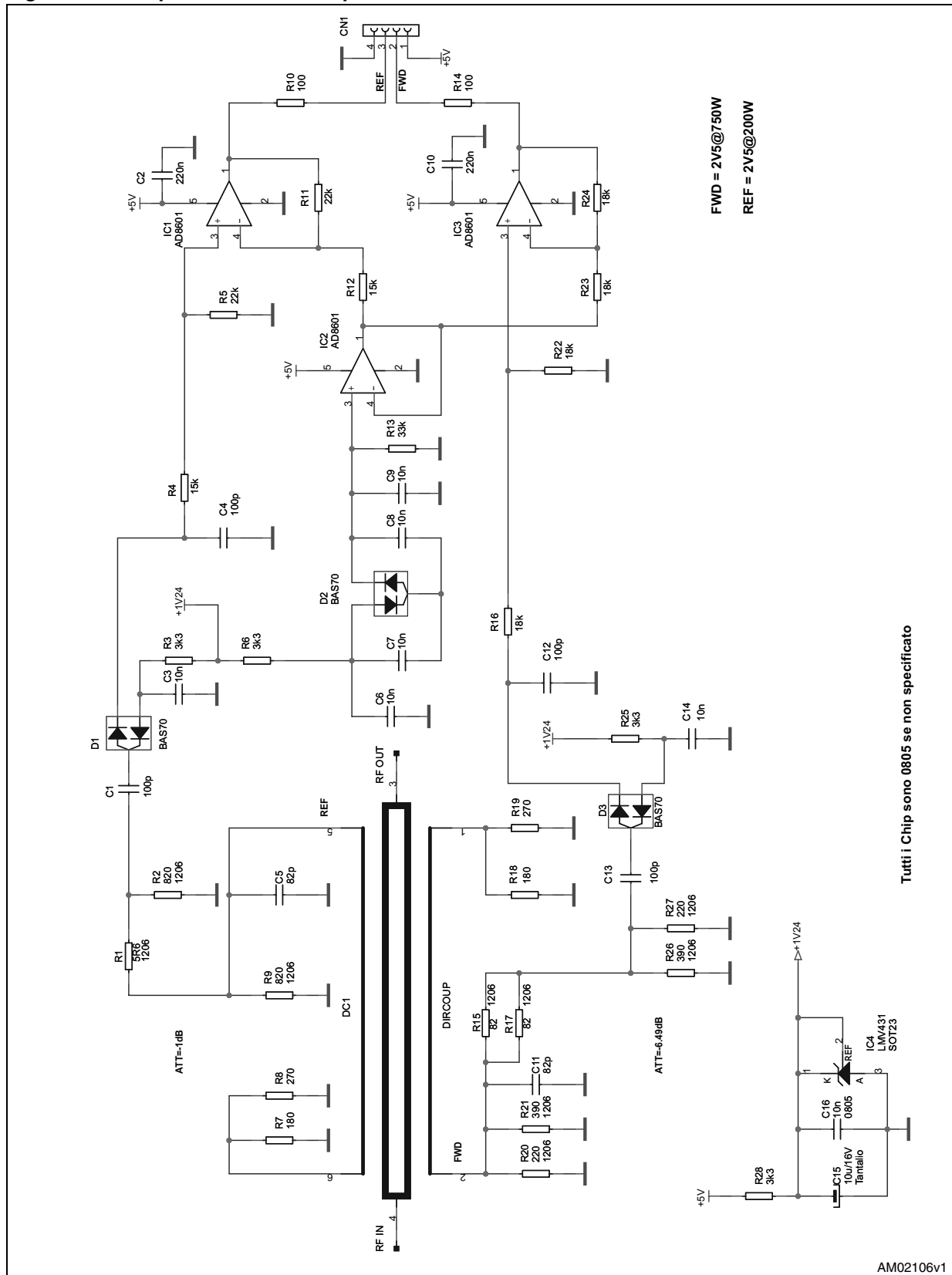
Figure 2. Input and protection board



- Notes:
- 1) If unspecified all resistors and capacitors are 0805
  - 2) D6 Macom MA4P12503 can be replaced by 3 Philips BAP64-03 PIN diodes
  - 3) If unspecified all 220n capacitors are 25V/Y5V/0805

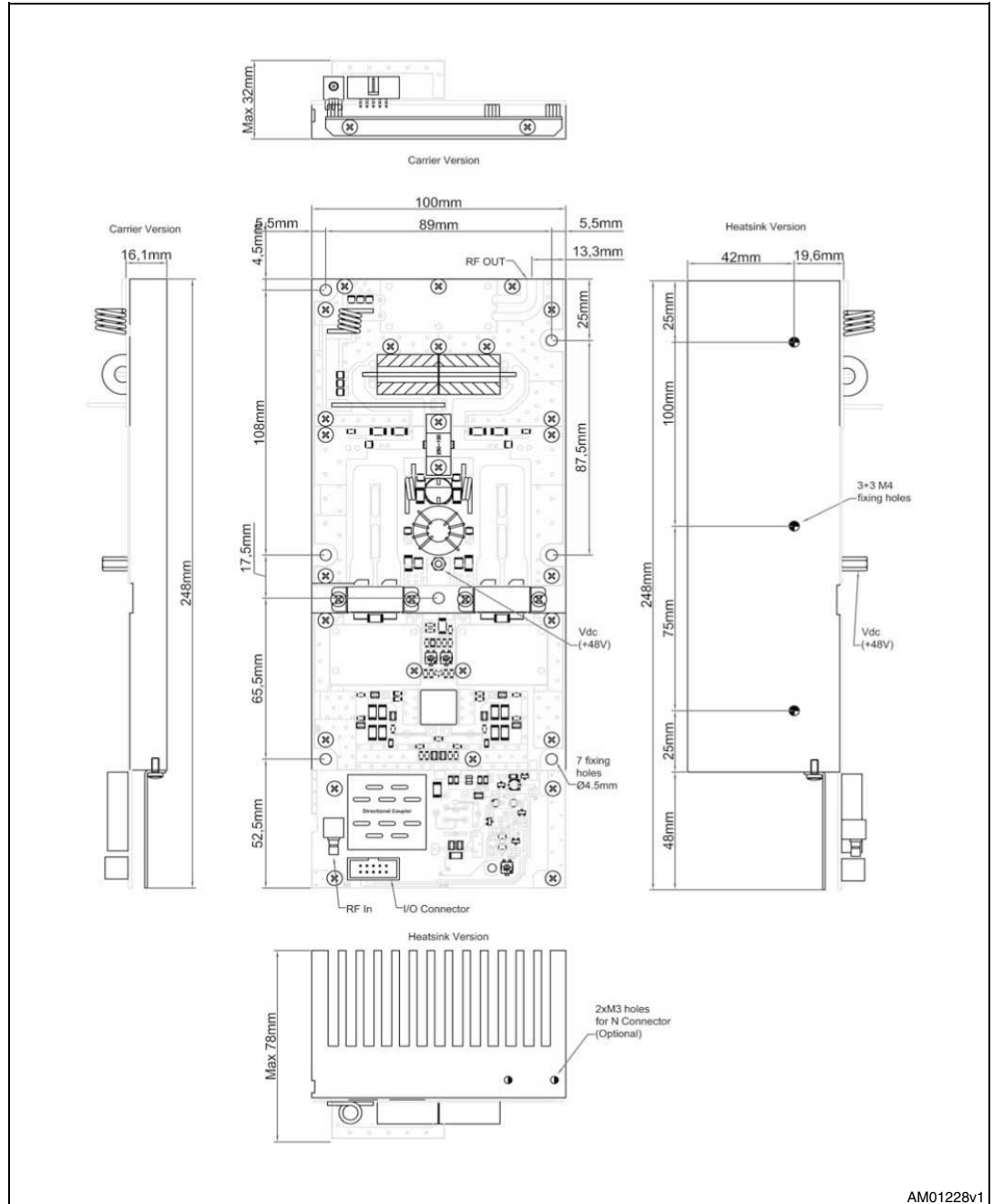


Figure 3. Output directional coupler



# 4 Circuit layout and connections

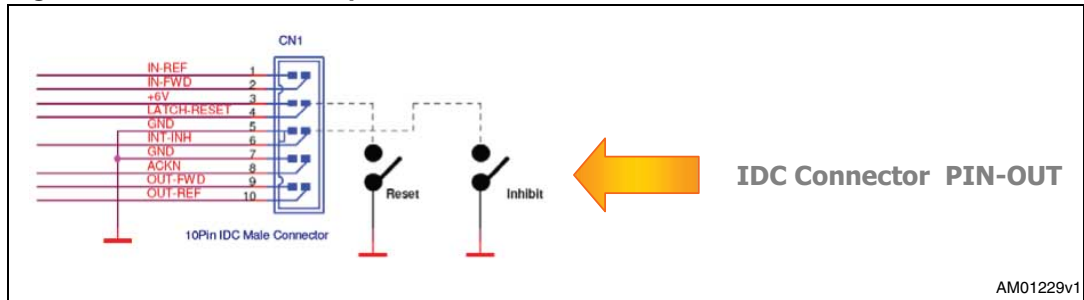
Figure 4. Circuit layout and connections



## 5 Features include

- 30 W input dummy load with automatic change-over case of alarm
- Input directional coupler
- Output directional coupler
- Input forward power measurement 2.5 V @ 10 W
- Input reflected power measurement 2.5 V @ 5 W
- Output forward power measurement 2.5 V @ 700 W
- Output reflected power measurement 2.5 V @ 250 W
- Latching protection
- Latch reset pin for manual restart (momentary to GND)
- Over reflected power ultrafast alarm (700 nS)
- Input pin for RF power inhibit
- Acknowledge pin alarm + 5 V

Figure 5. IDC connector piuout





## 6 SD2932 mounting recommendations

### 6.1 Mounting recommendations

- Ensure holes in heatsinks are free from burrs;
- Minimum depth of tapped holes in heatsinks is 6 mm;
- Use 4-40 UNC-2A cheese-head screws with a flat washer to spread the joint pressure;
- The minimum flatness of the mounting area is 0.02 mm;
- Mounting area roughness should be less than 0.5 μm (micro);
- Avoid, as much as possible, use of flux or flux solutions because flux can penetrate even when hermetically sealed ceramic-capped transistors. Tin and wash the printed-circuit board BEFORE mounting the power transistors, then solder the transistor leads without using flux;
- Transistor leads may be tinned by dipping them full-length into a solder bath at a temperature of about 230 °C. No flux should be used during tinning;
- Recommended heatsink compounds: WPSII (silicon free) from Austerlitz Electronics, 340 from dow corning etc.

### 6.2 Mounting sequence

- Apply a thin layer of evenly distributed heatsink compound to the flange;
- Position the device with flat washers in place;
- Tighten the screws until finger tight (0.05 Nm);
- Further tighten the screws until the specified torque is reached;
- For M174, M177 and M244 type of packages, torque should be minimum 0.6 Nm and 0.75 Nm max.

**Table 4. DMOS packages - list of materials**

Package Type	Description	Flange	Leadframe	Ceramic insulator	Plating		Torque (Nm)	
					Leads	Flange	Min	Max
M174	0.500 dia 4l non herm w/flange	Cu	Alloy 42 (Fe58 / Ni42)	BeO (99.5% min)	Au (100 μ min) over Ni (100 μ min / 350 μ max)	Ni(100 μ min) + Pd (10 μ min)	0.6	0.75
M174 (Moly disk)	0.500 dia 4l non herm w/flange (moly disk)	Cu-Mo-Cu	Alloy 42 (Fe58 / Ni42)	BeO (99.5% min)	Au (100 μ min) over Ni (100 μ min / 350 μ max)	Ni(100 μ min) + Pd (10 μ min)	0.6	0.75
M177	0.550 dia 4l non herm w/flange	Cu-Mo-Cu	Alloy 42 (Fe58 / Ni42)	BeO (99.5% min)	Au (60 μ min) over Ni (100 μ min / 350 μ max)	Au (100 μ min) over Ni (100 μ min / 350μ max)	0.6	0.75
M244	2 x 0.400x0.425 wide 2l lap n/h flange	W (85%) - Cu (15%)	Alloy 42 (Fe58 / Ni42)	BeO(99.5 % min)	Au (60 μ min) over Ni (100 μ min / 350μ max)	Au (60 μ min) over Ni (100 μ min / 350μ max)	0.6	0.75

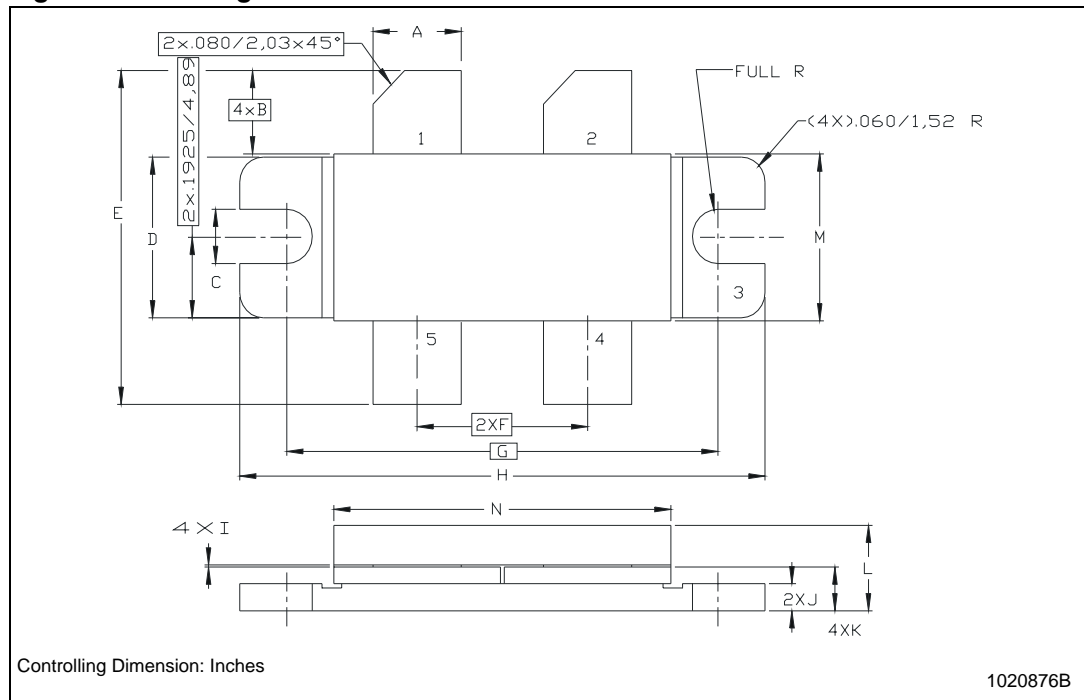
## 7 Package mechanical data:

In order to meet environmental requirements, ST offers these devices in different grades of ECOPACK® packages, depending on their level of environmental compliance. ECOPACK® specifications, grade definitions and product status are available at: [www.st.com](http://www.st.com). ECOPACK is an ST trademark.

Table 5. M244 (.400 x .860 4/L BAL N/HERM W/FLG) mechanical data

Dim.	mm.			Inch		
	Min	Typ	Max	Min	Typ	Max
A	5.59		5.84	0.220		0.230
B		5.08			0.200	
C	3.02		3.28	0.119		0.129
D	9.65		9.91	0.380		0.390
E	19.81		20.82	0.780		0.820
F	10.92		11.18	0.430		0.440
G		27.94			1.100	
H	33.91		34.16	1.335		1.345
I	0.10		0.15	0.004		0.006
J	1.52		1.78	0.060		0.070
K	2.59		2.84	0.102		0.112
L	4.83		5.84	0.190		0.230
M	10.03		10.34	0.395		0.407
N	21.59		22.10	0.850		0.870

Figure 6. Package dimensions



## 8 Revision history

**Table 6. Document revision history**

Date	Revision	Changes
02-Apr-2010	1	Initial release.

**Please Read Carefully:**

Information in this document is provided solely in connection with ST products. STMicroelectronics NV and its subsidiaries ("ST") reserve the right to make changes, corrections, modifications or improvements, to this document, and the products and services described herein at any time, without notice.

All ST products are sold pursuant to ST's terms and conditions of sale.

Purchasers are solely responsible for the choice, selection and use of the ST products and services described herein, and ST assumes no liability whatsoever relating to the choice, selection or use of the ST products and services described herein.

No license, express or implied, by estoppel or otherwise, to any intellectual property rights is granted under this document. If any part of this document refers to any third party products or services it shall not be deemed a license grant by ST for the use of such third party products or services, or any intellectual property contained therein or considered as a warranty covering the use in any manner whatsoever of such third party products or services or any intellectual property contained therein.

**UNLESS OTHERWISE SET FORTH IN ST'S TERMS AND CONDITIONS OF SALE ST DISCLAIMS ANY EXPRESS OR IMPLIED WARRANTY WITH RESPECT TO THE USE AND/OR SALE OF ST PRODUCTS INCLUDING WITHOUT LIMITATION IMPLIED WARRANTIES OF MERCHANTABILITY, FITNESS FOR A PARTICULAR PURPOSE (AND THEIR EQUIVALENTS UNDER THE LAWS OF ANY JURISDICTION), OR INFRINGEMENT OF ANY PATENT, COPYRIGHT OR OTHER INTELLECTUAL PROPERTY RIGHT.**

**UNLESS EXPRESSLY APPROVED IN WRITING BY AN AUTHORIZED ST REPRESENTATIVE, ST PRODUCTS ARE NOT RECOMMENDED, AUTHORIZED OR WARRANTED FOR USE IN MILITARY, AIR CRAFT, SPACE, LIFE SAVING, OR LIFE SUSTAINING APPLICATIONS, NOR IN PRODUCTS OR SYSTEMS WHERE FAILURE OR MALFUNCTION MAY RESULT IN PERSONAL INJURY, DEATH, OR SEVERE PROPERTY OR ENVIRONMENTAL DAMAGE. ST PRODUCTS WHICH ARE NOT SPECIFIED AS "AUTOMOTIVE GRADE" MAY ONLY BE USED IN AUTOMOTIVE APPLICATIONS AT USER'S OWN RISK.**

Resale of ST products with provisions different from the statements and/or technical features set forth in this document shall immediately void any warranty granted by ST for the ST product or service described herein and shall not create or extend in any manner whatsoever, any liability of ST.

ST and the ST logo are trademarks or registered trademarks of ST in various countries.

Information in this document supersedes and replaces all information previously supplied.

The ST logo is a registered trademark of STMicroelectronics. All other names are the property of their respective owners.

© 2010 STMicroelectronics - All rights reserved

STMicroelectronics group of companies

Australia - Belgium - Brazil - Canada - China - Czech Republic - Finland - France - Germany - Hong Kong - India - Israel - Italy - Japan - Malaysia - Malta - Morocco - Philippines - Singapore - Spain - Sweden - Switzerland - United Kingdom - United States of America

[www.st.com](http://www.st.com)

