

N-channel 800 V, 197 mΩ typ., 16 A MDmesh K6 Power MOSFET in a TO-220FP package

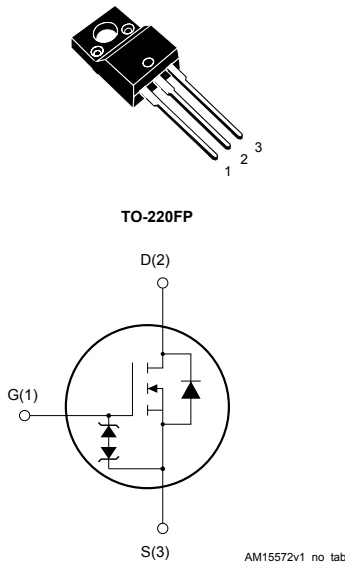

Features

Order code	V_{DS}	$R_{DS(on)}$ max.	I_D
STF80N240K6	800 V	220 mΩ	16 A

- Worldwide best $R_{DS(on)}$ x area
- Worldwide best FOM (figure of merit)
- Ultra low gate charge
- 100% avalanche tested
- Zener-protected

Applications

- Flyback converter
- Adapters for tablets, notebook and AIO
- LED lighting

Description

This very high voltage N-channel Power MOSFET is designed using the ultimate MDmesh K6 technology based on 20 years STMicroelectronics experience on super junction technology. The result is the best-in-class on-resistance per area and gate charge for applications requiring superior power density and high efficiency.

Product status link

[STF80N240K6](#)

Product summary

Order code	STF80N240K6
Marking	80N240K6
Package	TO-220FP
Packing	Tube

1 Electrical ratings

Table 1. Absolute maximum ratings

Symbol	Parameter	Value	Unit
V_{GS}	Gate-source voltage	± 30	V
$I_D^{(1)}$	Drain current (continuous) at $T_C = 25\text{ }^\circ\text{C}$	16	A
	Drain current (continuous) at $T_C = 100\text{ }^\circ\text{C}$	10	
$I_{DM}^{(2)}$	Drain current (pulsed)	35	A
P_{TOT}	Total power dissipation at $T_C = 25\text{ }^\circ\text{C}$	27	W
$di/dt^{(3)}$	Peak diode recovery voltage slope	5	V/ns
$dv/dt^{(3)}$	Peak diode recovery current slope	100	A/ μs
$dv/dt^{(4)}$	MOSFET dv/dt ruggedness	120	V/ns
V_{ISO}	Insulation withstand voltage (RMS) from all three leads to external heat sink ($t = 1\text{ s}$, $T_C = 25\text{ }^\circ\text{C}$)	2.5	kV
T_{stg}	Storage temperature range	-55 to 150	$^\circ\text{C}$
T_J	Operating junction temperature range		$^\circ\text{C}$

1. Limited by package.
2. Pulse width limited by safe operating area.
3. $I_{SD} \leq 4\text{ A}$; $V_{DD} = 400\text{ V}$
4. $V_{DS} \leq 640\text{ V}$

Table 2. Thermal data

Symbol	Parameter	Value	Unit
R_{thJC}	Thermal resistance, junction-to-case	4.7	$^\circ\text{C/W}$
R_{thJA}	Thermal resistance, junction-to-ambient	62.5	$^\circ\text{C/W}$

Table 3. Avalanche characteristics

Symbol	Parameter	Value	Unit
I_{AR}	Avalanche current, repetitive or not repetitive (pulse width limited by T_J max.)	3.3	A
E_{AS}	Single pulse avalanche energy (starting $T_J = 25\text{ }^\circ\text{C}$, $I_D = I_{AR}$, $V_{DD} = 50\text{ V}$)	200	mJ

2 Electrical characteristics

$T_C = 25\text{ °C}$ unless otherwise specified.

Table 4. On/off-state

Symbol	Parameter	Test conditions	Min.	Typ.	Max.	Unit
$V_{(BR)DSS}$	Drain-source breakdown voltage	$V_{GS} = 0\text{ V}$, $I_D = 1\text{ mA}$	800			V
I_{DSS}	Zero gate voltage drain current	$V_{GS} = 0\text{ V}$, $V_{DS} = 800\text{ V}$			1	μA
		$V_{GS} = 0\text{ V}$, $V_{DS} = 800\text{ V}$, $T_C = 125\text{ °C}^{(1)}$			50	
I_{GSS}	Gate body leakage current	$V_{DS} = 0\text{ V}$, $V_{GS} = \pm 20\text{ V}$			± 1	μA
$V_{GS(th)}$	Gate threshold voltage	$V_{DS} = V_{GS}$, $I_D = 100\text{ }\mu\text{A}$	3.0	3.5	4.0	V
$R_{DS(on)}$	Static drain-source on-resistance	$V_{GS} = 10\text{ V}$, $I_D = 7\text{ A}$		197	220	m Ω

1. Specified by design, not tested in production.

Table 5. Dynamic

Symbol	Parameter	Test conditions	Min.	Typ.	Max.	Unit
C_{iss}	Input capacitance	$V_{DS} = 400\text{ V}$, $f = 1\text{ MHz}$, $V_{GS} = 0\text{ V}$	-	1350	-	pF
C_{oss}	Output capacitance		-	20	-	pF
$C_{o(er)}^{(1)}$	Equivalent capacitance energy related	$V_{DS} = 0\text{ to }640\text{ V}$, $V_{GS} = 0\text{ V}$	-	25	-	pF
$C_{o(tr)}^{(2)}$	Equivalent capacitance time related		-	139	-	pF
R_G	Intrinsic gate resistance	$f = 1\text{ MHz}$, $I_D = 0\text{ A}$	-	1.8	-	Ω
Q_g	Total gate charge	$V_{DD} = 640\text{ V}$, $I_D = 7\text{ A}$, $V_{GS} = 0\text{ to }10\text{ V}$ (see Figure 18. Test circuit for gate charge behavior)	-	25.9	-	nC
Q_{gs}	Gate-source charge		-	6.9	-	nC
Q_{gd}	Gate-drain charge		-	8.4	-	nC

1. $C_{o(er)}$ is a constant capacitance value that gives the same stored energy as C_{oss} while V_{DS} is rising from 0 V to the stated value.

2. $C_{o(tr)}$ is a constant capacitance value that gives the same charging time as C_{oss} while V_{DS} is rising from 0 V to the stated value.

Table 6. Switching times

Symbol	Parameter	Test conditions	Min.	Typ.	Max.	Unit
$t_{d(on)}$	Turn-on delay time	$V_{DD} = 400\text{ V}$, $I_D = 7\text{ A}$, $R_G = 4.7\text{ }\Omega$, $V_{GS} = 10\text{ V}$	-	16	-	ns
t_r	Rise time		-	5.3	-	ns
$t_{d(off)}$	Turn-off delay time	see (Figure 16. Test circuit for resistive load switching times and Figure 17. Switching time waveform)	-	47.8	-	ns
t_f	Fall time		-	12	-	ns

Table 7. Source-drain diode

Symbol	Parameter	Test conditions	Min.	Typ.	Max.	Unit
$I_{SD}^{(1)}$	Source-drain current		-		16	A
$I_{SDM}^{(2)}$	Source-drain current (pulsed)		-		35	A
$V_{SD}^{(3)}$	Forward on voltage	$I_{SD} = 14\text{ A}, V_{GS} = 0\text{ V}$	-		1.5	V
t_{rr}	Reverse recovery time	$I_{SD} = 14\text{ A}, di/dt = 100\text{ A}/\mu\text{s},$	-	335		ns
Q_{rr}	Reverse recovery charge	$V_{DD} = 60\text{ V}$	-	5.4		μC
I_{RRM}	Reverse recovery current	(see Figure 19. Test circuit for inductive load switching and diode recovery times)	-	27.5		A
t_{rr}	Reverse recovery time	$I_{SD} = 14\text{ A}, di/dt = 100\text{ A}/\mu\text{s},$	-	430		ns
Q_{rr}	Reverse recovery charge	$V_{DD} = 60\text{ V}, T_J = 150\text{ }^\circ\text{C}$	-	7.4		μC
I_{RRM}	Reverse recovery current	(see Figure 19. Test circuit for inductive load switching and diode recovery times)	-	28		A

1. Limited by package.
2. Pulse width limited by safe operating area.
3. Pulsed: pulse duration = 300 μs , duty cycle 1.5%.

2.1 Electrical characteristics (curves)

Figure 1. Safe operating area

Figure 2. Maximum transient thermal impedance

Figure 3. Typical output characteristics

Figure 4. Typical transfer characteristics

Figure 5. Typical drain-source on-resistance

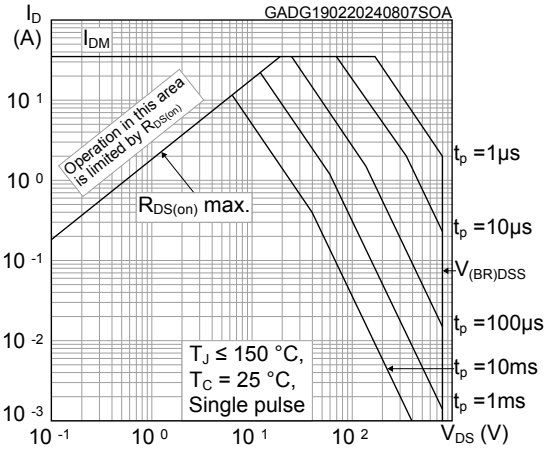
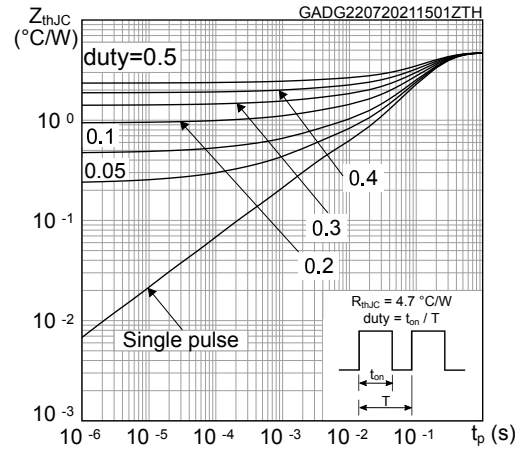
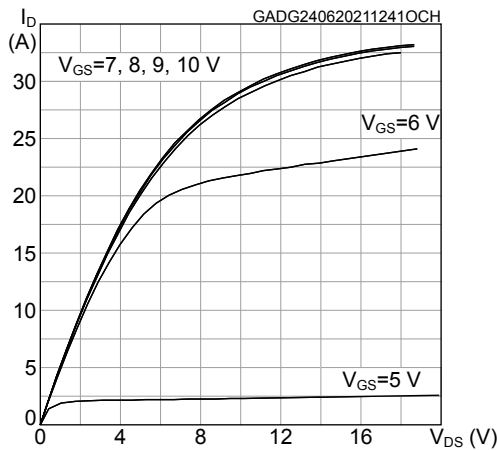
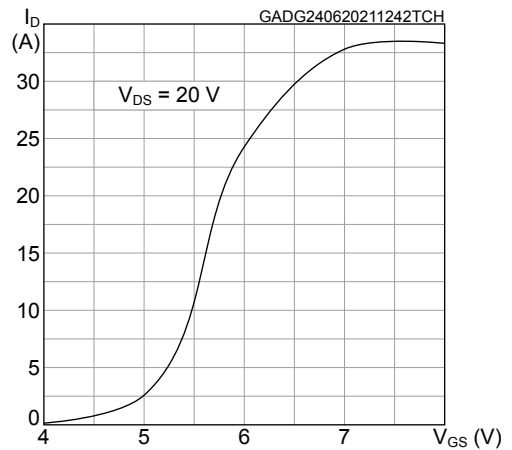
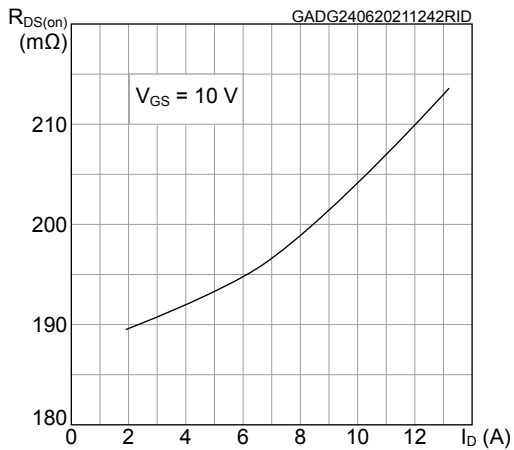
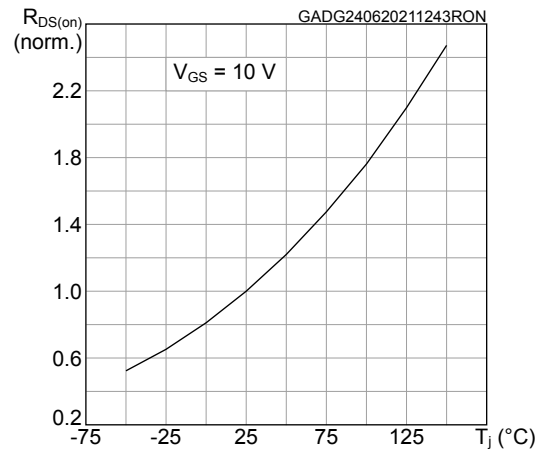
Figure 6. Normalized on-resistance vs temperature

Figure 7. Typical gate charge characteristics

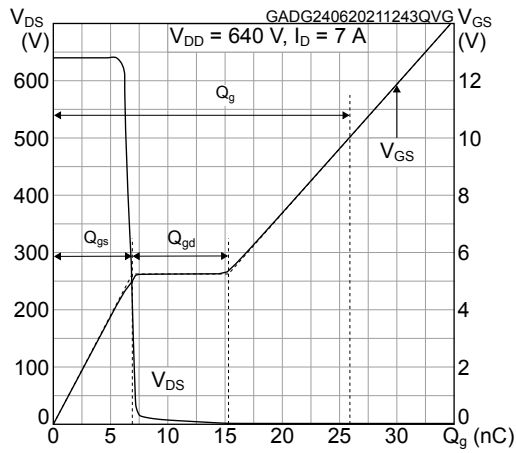

Figure 8. Typical capacitance characteristics

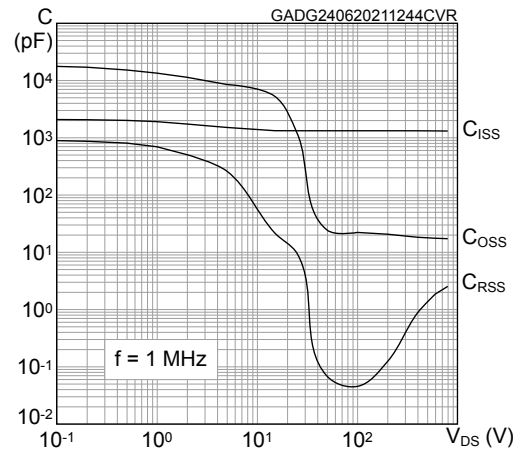

Figure 9. Normalized gate threshold vs temperature

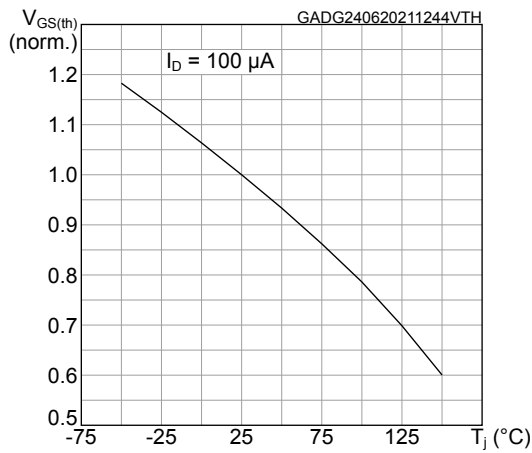

Figure 10. Normalized breakdown voltage vs temperature

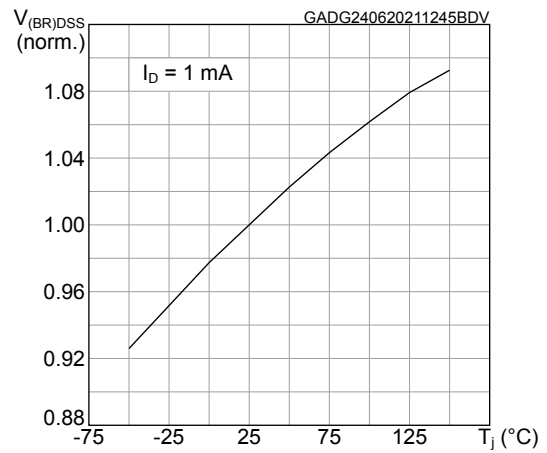

Figure 11. Typical output capacitance stored energy

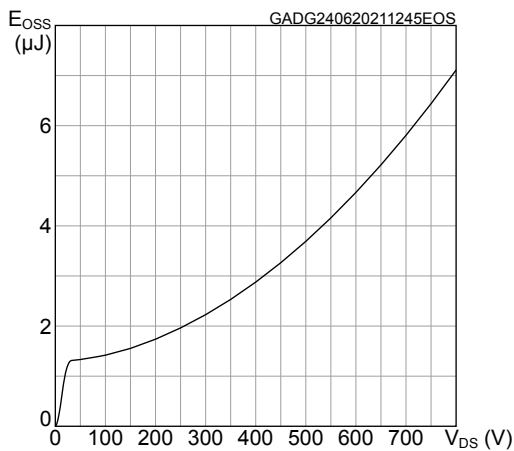

Figure 12. Maximum avalanche energy vs temperature

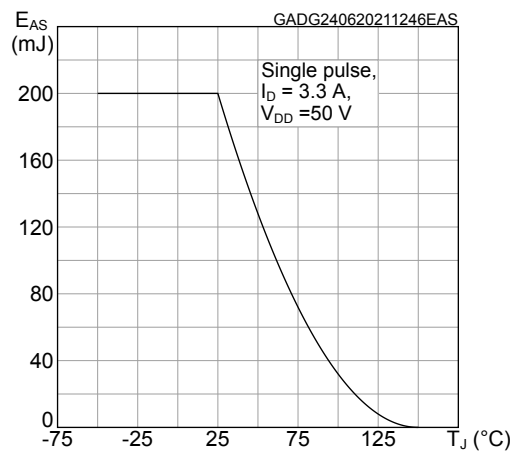

Figure 13. Typical reverse diode forward characteristics

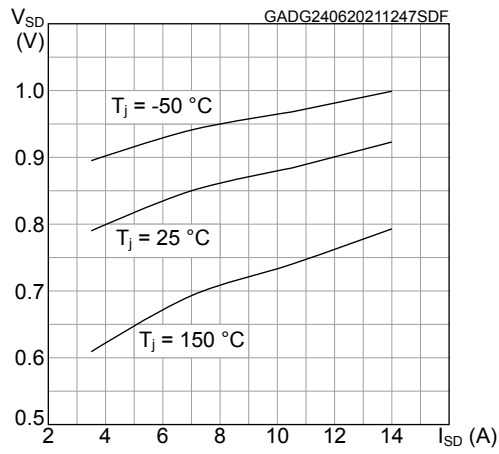

Figure 14. Typical inductive load switching energy vs I_D

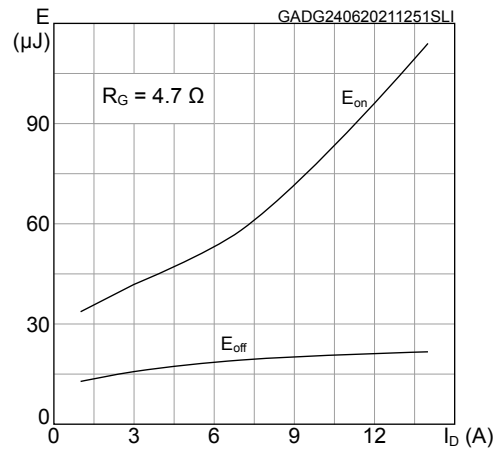
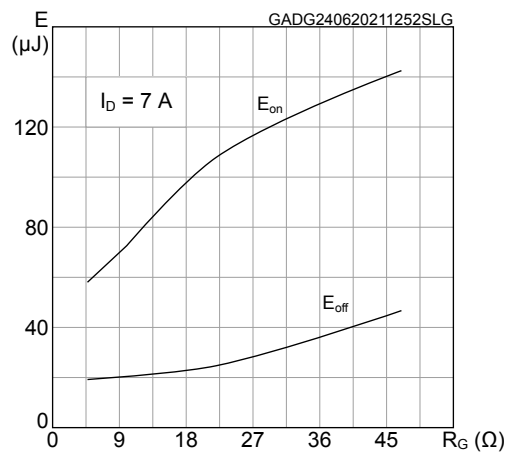
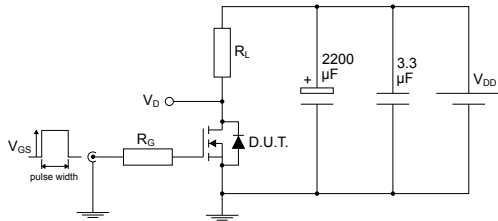

Figure 15. Typical inductive load switching energy vs R_G



3 Test circuits

Figure 16. Test circuit for resistive load switching times

AM01468v1

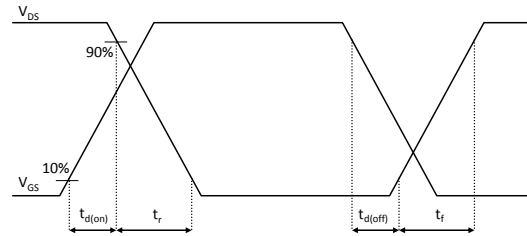
Figure 17. Switching time waveform

GADG280620211209SA

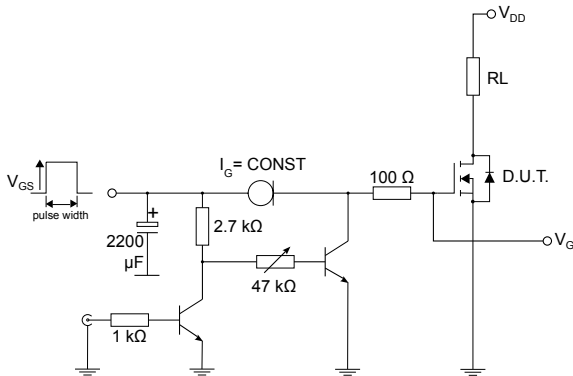
Figure 18. Test circuit for gate charge behavior

AM01469v10

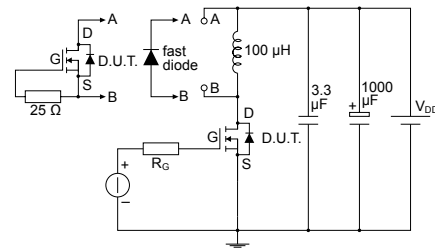
Figure 19. Test circuit for inductive load switching and diode recovery times

AM01470v1

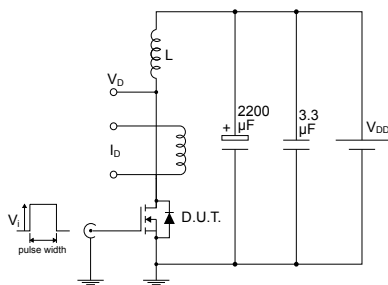
Figure 20. Unclamped inductive load test circuit

AM01471v1

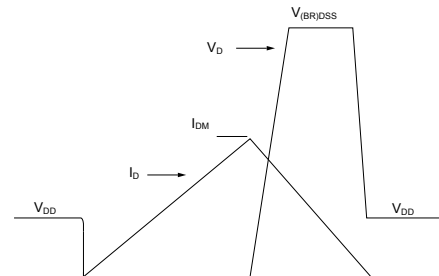
Figure 21. Unclamped inductive waveform

AM01472v1

4 Package information

In order to meet environmental requirements, ST offers these devices in different grades of **ECOPACK** packages, depending on their level of environmental compliance. ECOPACK specifications, grade definitions and product status are available at: www.st.com. ECOPACK is an ST trademark.

4.1 TO-220FP type B package information

Figure 22. TO-220FP type B package outline

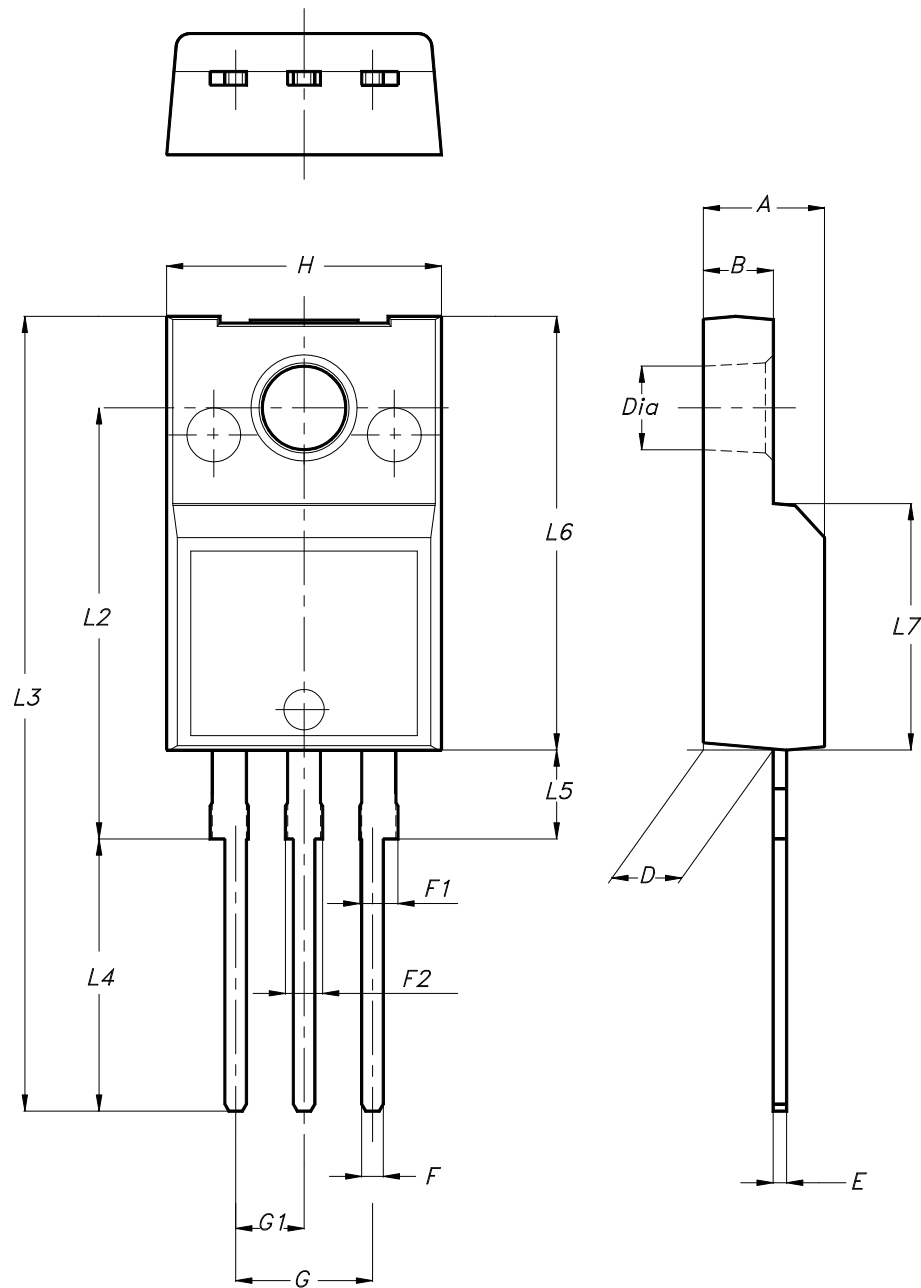

7012510_B_rev.14

Table 8. TO-220FP type B package mechanical data

Dim.	mm		
	Min.	Typ.	Max.
A	4.40		4.60
B	2.50		2.70
D	2.50		2.75
E	0.45		0.70
F	0.75		1.00
F1	1.15		1.70
F2	1.15		1.70
G	4.95		5.20
G1	2.40		2.70
H	10.00		10.40
L2		16.00	
L3	28.60		30.60
L4	9.80		10.60
L5	2.90		3.60
L6	15.90		16.40
L7	9.00		9.30
Dia	3.00		3.20

Revision history

Table 9. Document revision history

Date	Revision	Changes
26-Jul-2021	1	First release.
01-Dec-2023	2	Updated <i>Applications</i> on cover page. Updated <i>Section 1 Electrical ratings</i> and <i>Table 7. Source-drain diode</i> . Minor text changes.
19-Feb-2024	3	Replaced Figure 1. Safe operating area .

Contents

1	Electrical ratings	2
2	Electrical characteristics	3
2.1	Electrical characteristics (curves)	5
3	Test circuits	8
4	Package information	9
4.1	TO-220FP type B package information	9
	Revision history	11

IMPORTANT NOTICE – READ CAREFULLY

STMicroelectronics NV and its subsidiaries (“ST”) reserve the right to make changes, corrections, enhancements, modifications, and improvements to ST products and/or to this document at any time without notice. Purchasers should obtain the latest relevant information on ST products before placing orders. ST products are sold pursuant to ST’s terms and conditions of sale in place at the time of order acknowledgment.

Purchasers are solely responsible for the choice, selection, and use of ST products and ST assumes no liability for application assistance or the design of purchasers’ products.

No license, express or implied, to any intellectual property right is granted by ST herein.

Resale of ST products with provisions different from the information set forth herein shall void any warranty granted by ST for such product.

ST and the ST logo are trademarks of ST. For additional information about ST trademarks, refer to www.st.com/trademarks. All other product or service names are the property of their respective owners.

Information in this document supersedes and replaces information previously supplied in any prior versions of this document.

© 2024 STMicroelectronics – All rights reserved