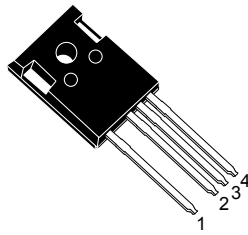
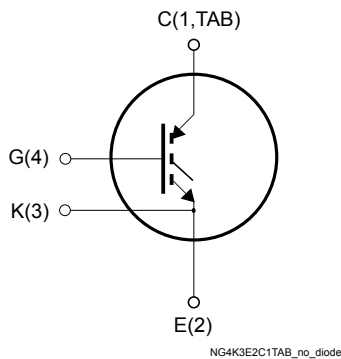

Trench gate field-stop, 650 V, 100 A, high-speed HB2 series IGBT in a TO247-4 package

TO247-4

Features

- Maximum junction temperature: $T_J = 175\text{ °C}$
- Low $V_{CE(sat)} = 1.55\text{ V (typ.) @ } I_C = 100\text{ A}$
- Minimized tail current
- Tight parameter distribution
- Low thermal resistance
- Positive $V_{CE(sat)}$ temperature coefficient
- Excellent switching performance thanks to the extra driving kelvin pin

Applications

- Welding
- Power factor correction
- UPS
- Solar inverters
- Chargers

Description

The newest IGBT 650 V HB2 series represents an evolution of the advanced proprietary trench gate field-stop structure. The performance of the HB2 series is optimized in terms of conduction, thanks to a better $V_{CE(sat)}$ behavior at low current values, as well as in terms of reduced switching energy. The result is a product specifically designed to maximize efficiency for a wide range of fast applications.

Product status link

[STGW100H65FB2-4](#)

Product summary

Order code	STGW100H65FB2-4
Marking	G100H65FB2
Package	TO247-4
Packing	Tube

1 Electrical ratings

Table 1. Absolute maximum ratings

Symbol	Parameter	Value	Unit
V_{CES}	Collector-emitter voltage ($V_{GE} = 0$ V)	650	V
I_C	Continuous collector current at $T_C = 25$ °C	145	A
	Continuous collector current at $T_C = 100$ °C	91	
$I_{CP}^{(1)}$	Pulsed collector current ($t_p \leq 1$ μ s, $T_J < 175$ °C)	300	
V_{GE}	Gate-emitter voltage	± 20	V
	Transient gate-emitter voltage ($t_p \leq 10$ μ s)	± 30	
P_{TOT}	Total power dissipation at $T_C = 25$ °C	441	W
T_{STG}	Storage temperature range	-55 to 150	°C
T_J	Operating junction temperature range	-55 to 175	

1. Defined by design, not subject to production test.

Table 2. Thermal data

Symbol	Parameter	Value	Unit
R_{thJC}	Thermal resistance junction-case	0.34	°C/W
R_{thJA}	Thermal resistance junction-ambient	50	

2 Electrical characteristics

$T_C = 25\text{ °C}$ unless otherwise specified

Table 3. Static characteristics

Symbol	Parameter	Test conditions	Min.	Typ.	Max.	Unit
$V_{(BR)CES}$	Collector-emitter breakdown voltage	$V_{GE} = 0\text{ V}$, $I_C = 1\text{ mA}$	650			V
$V_{CE(sat)}$	Collector-emitter saturation voltage	$V_{GE} = 15\text{ V}$, $I_C = 100\text{ A}$		1.55	2	V
		$V_{GE} = 15\text{ V}$, $I_C = 100\text{ A}$, $T_J = 125\text{ °C}$		1.8		
		$V_{GE} = 15\text{ V}$, $I_C = 100\text{ A}$, $T_J = 175\text{ °C}$		1.9		
$V_{GE(th)}$	Gate threshold voltage	$V_{CE} = V_{GE}$, $I_C = 1\text{ mA}$	5	6	7	V
I_{CES}	Collector cut-off current	$V_{GE} = 0\text{ V}$, $V_{CE} = 650\text{ V}$			25	μA
I_{GES}	Gate-emitter leakage current	$V_{CE} = 0\text{ V}$, $V_{GE} = \pm 20\text{ V}$			± 250	nA

Table 4. Dynamic characteristics

Symbol	Parameter	Test conditions	Min.	Typ.	Max.	Unit
C_{ies}	Input capacitance	$V_{CE} = 25\text{ V}$, $f = 1\text{ MHz}$, $V_{GE} = 0\text{ V}$	-	6227	-	μF
C_{oes}	Output capacitance		-	318	-	
C_{res}	Reverse transfer capacitance		-	165	-	
Q_g	Total gate charge	$V_{CC} = 520\text{ V}$, $I_C = 100\text{ A}$, $V_{GE} = 0\text{ to }15\text{ V}$ (see Figure 22. Gate charge test circuit)	-	288	-	nC
Q_{ge}	Gate-emitter charge		-	48	-	
Q_{gc}	Gate-collector charge		-	120	-	

Table 5. Switching characteristics (inductive load)

Symbol	Parameter	Test conditions	Min.	Typ.	Max.	Unit
$t_{d(on)}$	Turn-on delay time	$V_{CC} = 400\text{ V}$, $I_C = 100\text{ A}$, $V_{GK} = 15\text{ V}$, $R_{G(on)} = 8.2\ \Omega$, $R_{G(off)} = 3.3\ \Omega$ (see Figure 21. Test circuit for inductive load switching)	-	23	-	ns
t_r	Current rise time		-	28	-	ns
$E_{on(1)}$	Turn-on switching energy		-	1059	-	μJ
$t_{d(off)}$	Turn-off delay time		-	141	-	ns
t_f	Current fall time		-	13	-	ns
$E_{off(2)}$	Turn-off switching energy		-	1137	-	μJ
$t_{d(on)}$	Turn-on delay time	$V_{CC} = 400\text{ V}$, $I_C = 100\text{ A}$, $V_{GK} = 15\text{ V}$, $R_{G(on)} = 8.2\ \Omega$, $R_{G(off)} = 3.3\ \Omega$, $T_J = 175\text{ }^\circ\text{C}$ (see Figure 21. Test circuit for inductive load switching)	-	19	-	ns
t_r	Current rise time		-	30	-	ns
$E_{on(1)}$	Turn-on switching energy		-	2061	-	μJ
$t_{d(off)}$	Turn-off delay time		-	176	-	ns
t_f	Current fall time		-	79	-	ns
$E_{off(2)}$	Turn-off switching energy		-	2154	-	μJ

1. Including the reverse recovery of the diode. The diode is the same of the co-packed STGWA100H65DFB2.
2. Including the tail of the collector current.

2.1 Electrical characteristics (curves)

Figure 1. Power dissipation vs case temperature

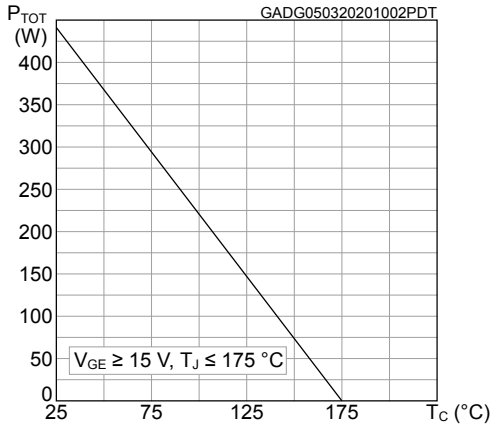

Figure 2. Collector current vs case temperature

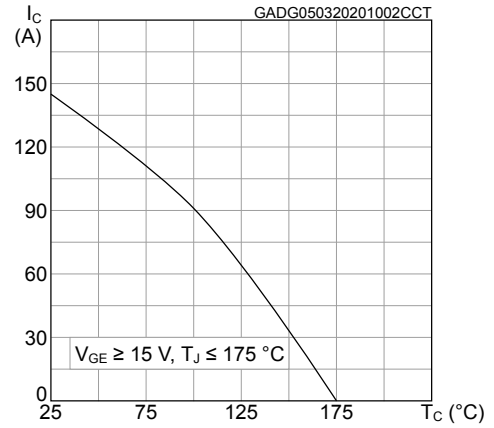

Figure 3. Output characteristics (T_J = 25 °C)

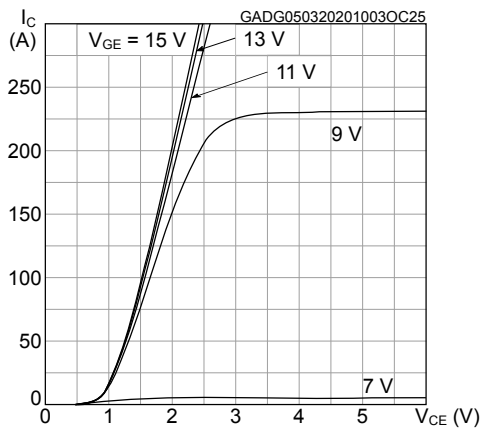

Figure 4. Output characteristics (T_J = 175 °C)

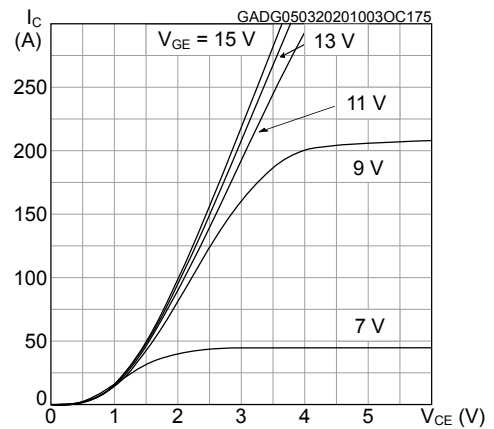

Figure 5. V_{CE(sat)} vs junction temperature

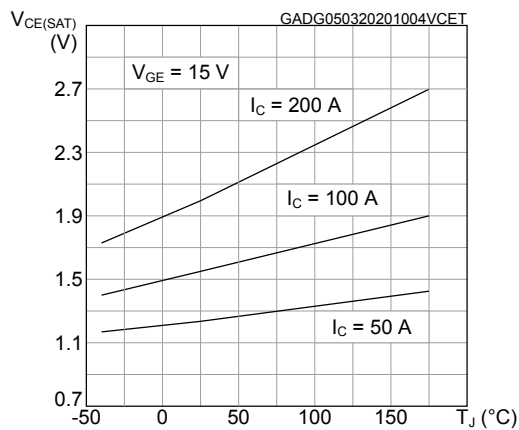

Figure 6. V_{CE(sat)} vs collector current

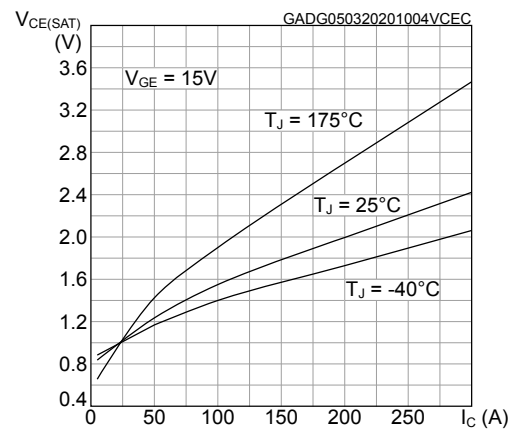

Figure 7. Collector current vs switching frequency

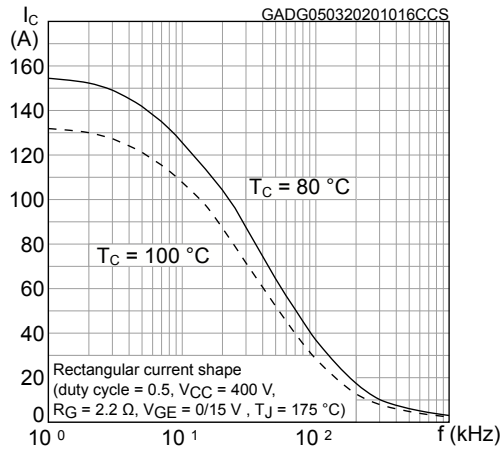

Figure 8. Forward bias safe operating area

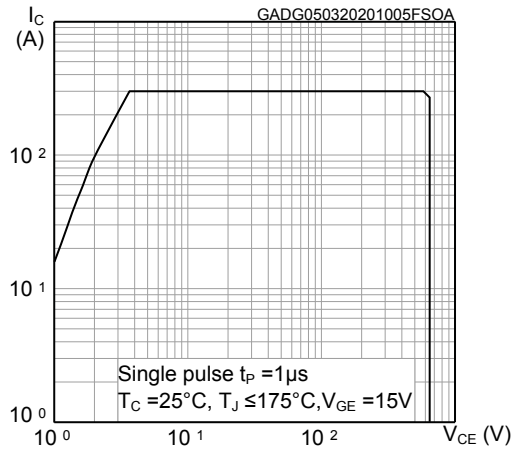

Figure 9. Transfer characteristics

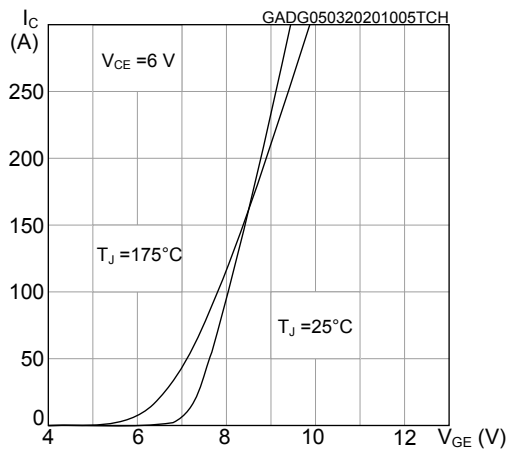

Figure 10. Normalized VGE(th) vs junction temperature

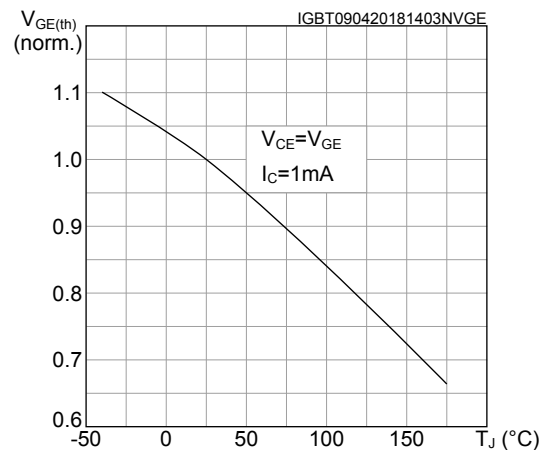

Figure 11. Normalized V(BR)CES vs junction temperature

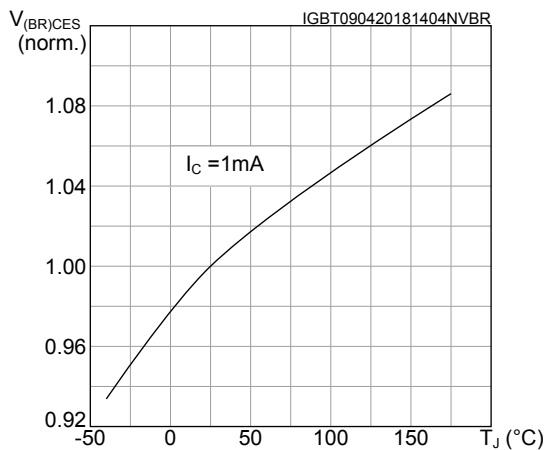

Figure 12. Capacitance variations

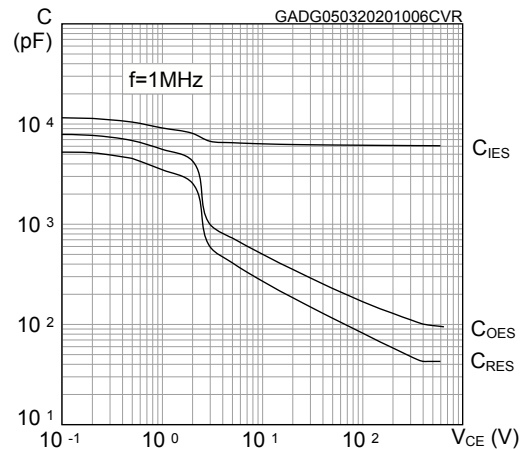

Figure 13. Gate charge vs gate-emitter voltage

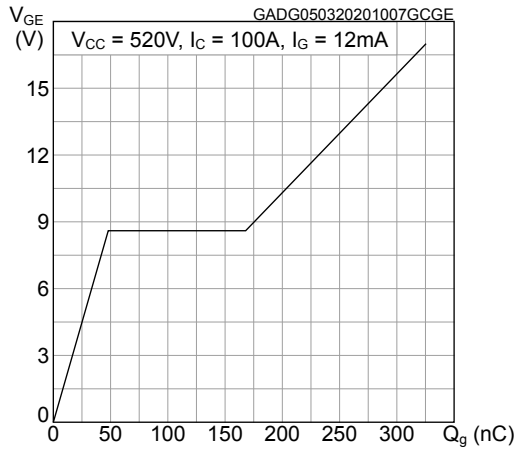

Figure 14. Switching energy vs collector current

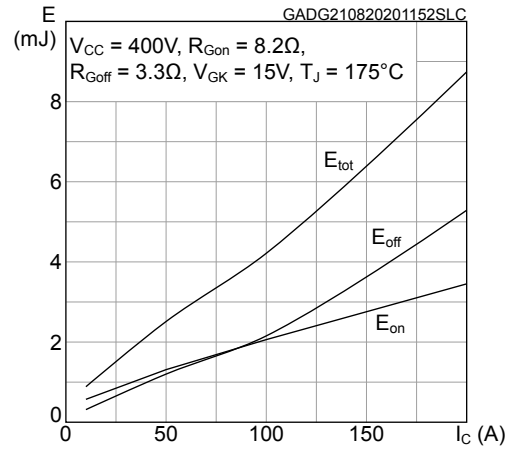

Figure 15. Switching energy vs temperature

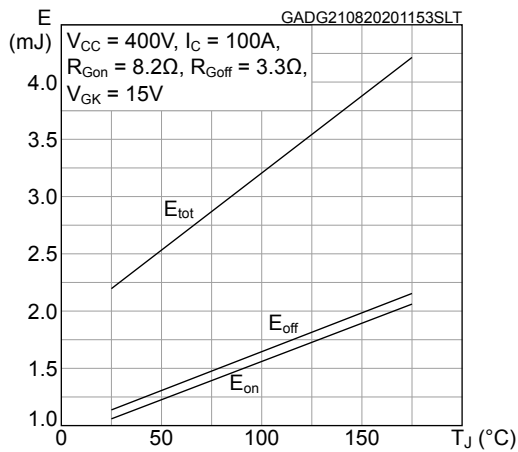

Figure 16. Switching energy vs collector emitter voltage

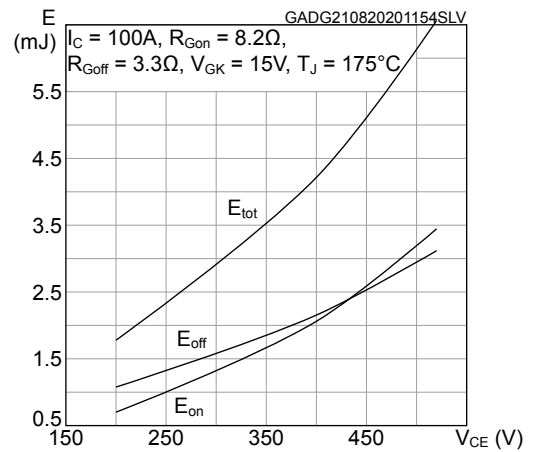

Figure 17. Switching energy vs gate resistance

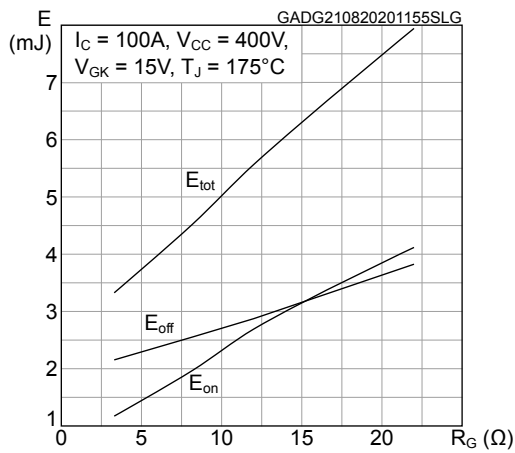

Figure 18. Switching times vs collector current

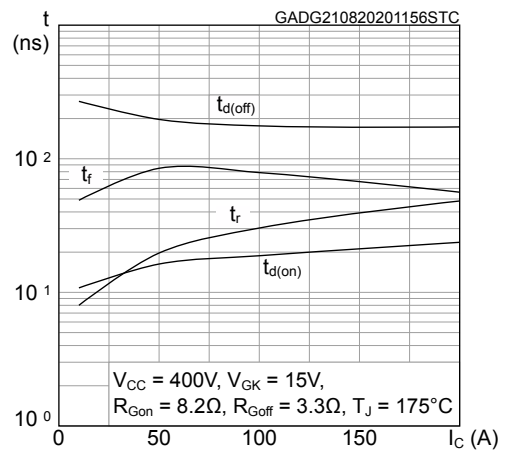

Figure 19. Switching times vs gate resistance

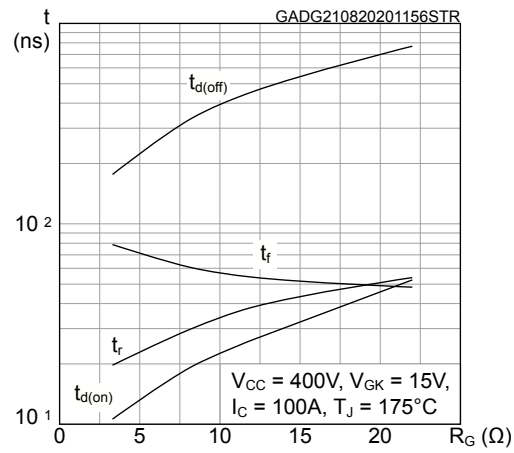
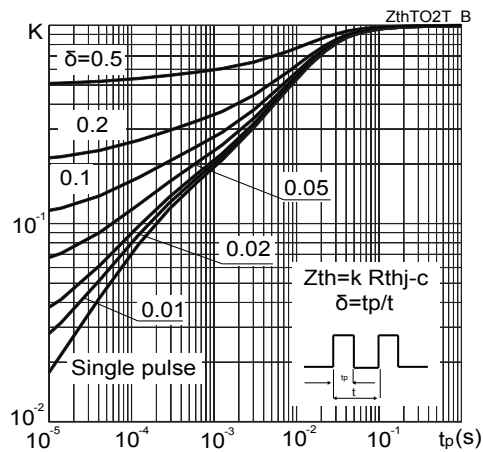

Figure 20. Thermal impedance



3 Test circuits

Figure 21. Test circuit for inductive load switching

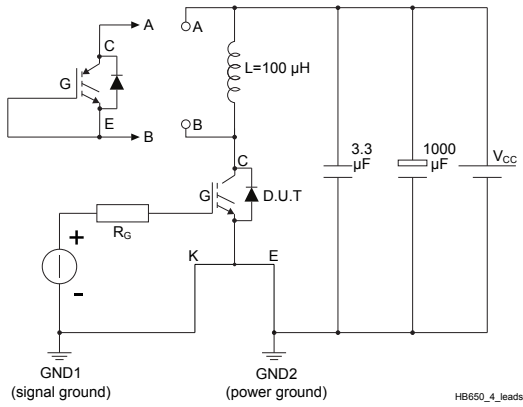

Figure 22. Gate charge test circuit

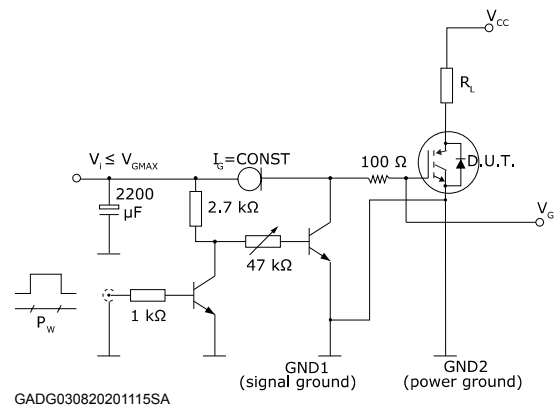
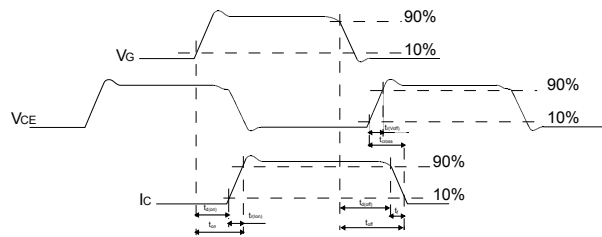

Figure 23. Switching waveform



AM01506v1

4 Package information

In order to meet environmental requirements, ST offers these devices in different grades of **ECOPACK** packages, depending on their level of environmental compliance. ECOPACK specifications, grade definitions and product status are available at: www.st.com. ECOPACK is an ST trademark.

4.1 TO247-4 package information

Figure 24. TO247-4 package outline

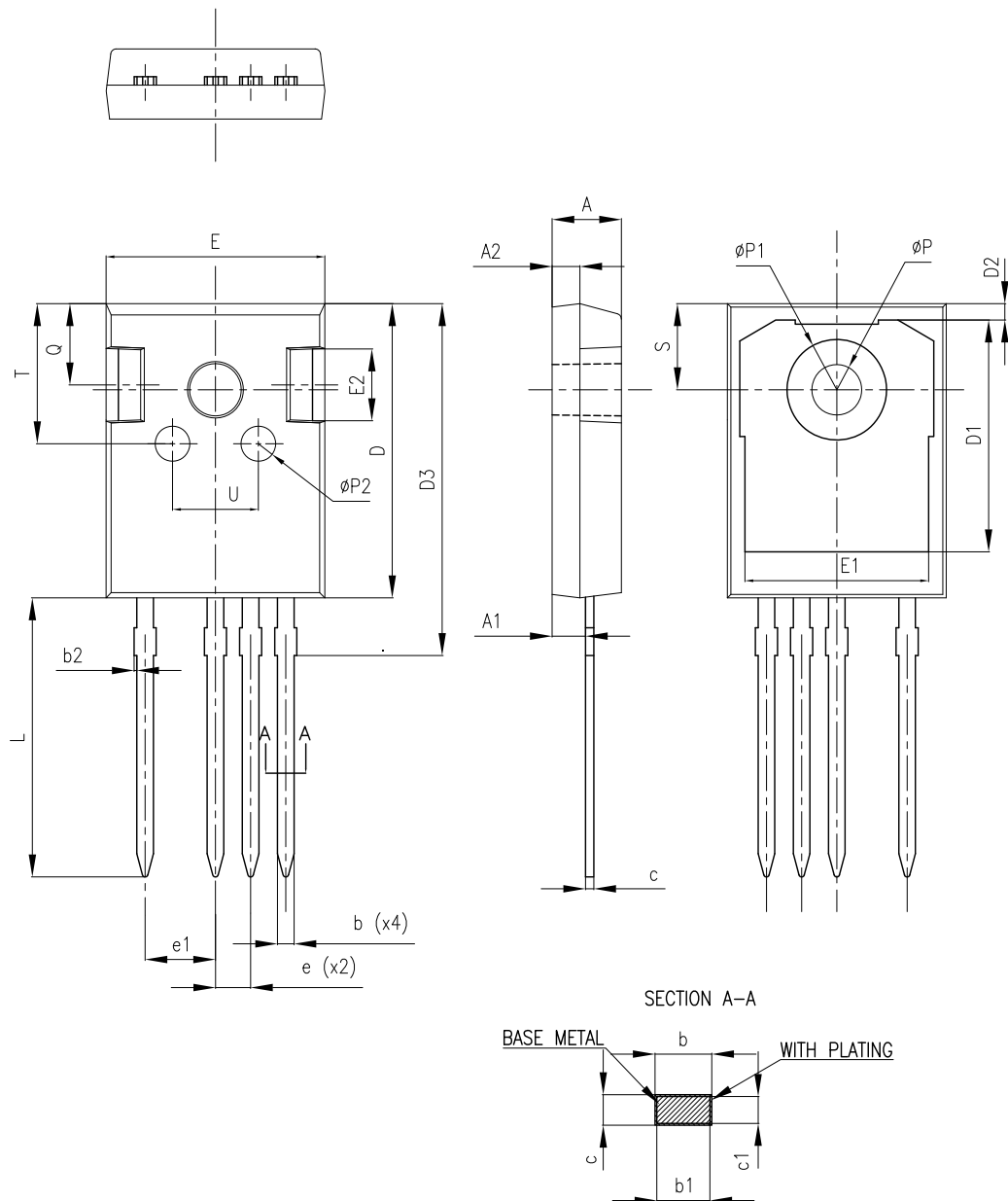

8405626_2

Table 6. TO247-4 mechanical data

Dim.	mm		
	Min.	Typ.	Max.
A	4.90	5.00	5.10
A1	2.31	2.41	2.51
A2	1.90	2.00	2.10
b	1.16		1.29
b1	1.15	1.20	1.25
b2	0		0.20
c	0.59		0.66
c1	0.58	0.60	0.62
D	20.90	21.00	21.10
D1	16.25	16.55	16.85
D2	1.05	1.20	1.35
D3	24.97	25.12	25.27
E	15.70	15.80	15.90
E1	13.10	13.30	13.50
E2	4.90	5.00	5.10
E3	2.40	2.50	2.60
e	2.44	2.54	2.64
e1	4.98	5.08	5.18
L	19.80	19.92	20.10
P	3.50	3.60	3.70
P1			7.40
P2	2.40	2.50	2.60
Q	5.60		6.00
S		6.15	
T	9.80		10.20
U	6.00		6.40

Revision history

Table 7. Document revision history

Date	Version	Changes
09-Sep-2020	1	First release.
10-Sep-2020	2	Updated product status link in cover page.

Contents

1	Electrical ratings	2
2	Electrical characteristics	3
2.1	Electrical characteristics (curves)	5
3	Test circuits	9
4	Package information	10
4.1	TO247-4 package information	10
	Revision history	12

IMPORTANT NOTICE – PLEASE READ CAREFULLY

STMicroelectronics NV and its subsidiaries (“ST”) reserve the right to make changes, corrections, enhancements, modifications, and improvements to ST products and/or to this document at any time without notice. Purchasers should obtain the latest relevant information on ST products before placing orders. ST products are sold pursuant to ST’s terms and conditions of sale in place at the time of order acknowledgement.

Purchasers are solely responsible for the choice, selection, and use of ST products and ST assumes no liability for application assistance or the design of Purchasers’ products.

No license, express or implied, to any intellectual property right is granted by ST herein.

Resale of ST products with provisions different from the information set forth herein shall void any warranty granted by ST for such product.

ST and the ST logo are trademarks of ST. For additional information about ST trademarks, please refer to www.st.com/trademarks. All other product or service names are the property of their respective owners.

Information in this document supersedes and replaces information previously supplied in any prior versions of this document.

© 2020 STMicroelectronics – All rights reserved