

Trench gate field-stop, 650 V, 50 A, high-speed HB2 series IGBT in a TO-247 long leads package

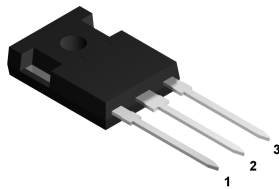

TO-247 long leads

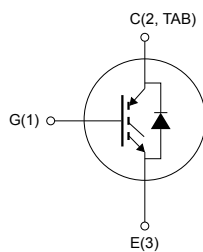

NG1E3C2T



Features

- Maximum junction temperature : $T_J = 175\text{ }^\circ\text{C}$
- Low $V_{CE(sat)} = 1.55\text{ V (typ.) @ } I_C = 50\text{ A}$
- Co-packaged protection diode
- Minimized tail current
- Tight parameter distribution
- Low thermal resistance
- Positive $V_{CE(sat)}$ temperature coefficient

Applications

- Welding
- Power factor correction

Description

The newest IGBT 650 V HB2 series represents an evolution of the advanced proprietary trench gate field-stop structure. The performance of the HB2 series is optimized in terms of conduction, thanks to a better $V_{CE(sat)}$ behavior at low current values, as well as in terms of reduced switching energy. A diode used for protection purposes only is co-packaged in antiparallel with the IGBT. The result is a product specifically designed to maximize efficiency for a wide range of fast applications.

Product status link

[STGWA50HP65FB2](#)

Product summary

Order code	STGWA50HP65FB2
Marking	G50HP65FB2
Package	TO-247 long leads
Packing	Tube

1 Electrical ratings

Table 1. Absolute maximum ratings

Symbol	Parameter	Value	Unit
V_{CES}	Collector-emitter voltage ($V_{GE} = 0$ V)	650	V
I_C	Continuous collector current at $T_C = 25$ °C	86	A
	Continuous collector current at $T_C = 100$ °C	53	A
$I_{CP}^{(1)}$	Pulsed collector current	150	A
V_{GE}	Gate-emitter voltage	±20	V
	Transient gate-emitter voltage ($t_p \leq 10$ µs)	±30	
I_F	Continuous forward current at $T_C = 25$ °C	5	A
	Continuous forward current at $T_C = 100$ °C	5	
$I_{FP}^{(1)}$	Pulsed forward current	10	A
P_{TOT}	Total power dissipation at $T_C = 25$ °C	272	W
T_{STG}	Storage temperature range	-55 to 150	°C
T_J	Operating junction temperature range	-55 to 175	°C

1. Pulse width is limited by maximum junction temperature.

Table 2. Thermal data

Symbol	Parameter	Value	Unit
R_{thJC}	Thermal resistance junction-case IGBT	0.55	°C/W
	Thermal resistance junction-case diode	5	
R_{thJA}	Thermal resistance junction-ambient	50	

2 Electrical characteristics

$T_C = 25\text{ °C}$ unless otherwise specified.

Table 3. Static characteristics

Symbol	Parameter	Test conditions	Min.	Typ.	Max.	Unit
$V_{(BR)CES}$	Collector-emitter breakdown voltage	$V_{GE} = 0\text{ V}, I_C = 1\text{ mA}$	650			V
$V_{CE(sat)}$	Collector-emitter saturation voltage	$V_{GE} = 15\text{ V}, I_C = 50\text{ A}$		1.55	2	V
		$V_{GE} = 15\text{ V}, I_C = 50\text{ A}, T_J = 125\text{ °C}$		1.8		
		$V_{GE} = 15\text{ V}, I_C = 50\text{ A}, T_J = 175\text{ °C}$		1.9		
V_F	Forward on-voltage	$I_F = 5\text{ A}$		2.6	3.5	V
		$I_F = 5\text{ A}, T_J = 125\text{ °C}$		2.3		
		$I_F = 5\text{ A}, T_J = 175\text{ °C}$		2.2		
$V_{GE(th)}$	Gate threshold voltage	$V_{CE} = V_{GE}, I_C = 1\text{ mA}$	5	6	7	V
I_{CES}	Collector cut-off current	$V_{GE} = 0\text{ V}, V_{CE} = 650\text{ V}$			25	μA
I_{GES}	Gate-emitter leakage current	$V_{CE} = 0\text{ V}, V_{GE} = \pm 20\text{ V}$			± 250	nA

Table 4. Dynamic characteristics

Symbol	Parameter	Test conditions	Min.	Typ.	Max.	Unit
C_{ies}	Input capacitance	$V_{CE} = 25\text{ V}, f = 1\text{ MHz}, V_{GE} = 0\text{ V}$	-	2928	-	pF
C_{oes}	Output capacitance		-	162	-	
C_{res}	Reverse transfer capacitance		-	78	-	
Q_g	Total gate charge	$V_{CC} = 520\text{ V}, I_C = 50\text{ A},$	-	151	-	nC
Q_{ge}	Gate-emitter charge	$V_{GE} = 0\text{ to }15\text{ V}$	-	30	-	
Q_{gc}	Gate-collector charge	(see Figure 26. Gate charge test circuit)	-	63	-	

Table 5. Switching characteristics (inductive load)

Symbol	Parameter	Test conditions	Min.	Typ.	Max.	Unit
$t_{d(off)}$	Turn-off delay time	$V_{CC} = 400\text{ V}, I_C = 50\text{ A},$	-	115	-	ns
t_f	Current fall time	$V_{GE} = 15\text{ V}, R_G = 4.7\ \Omega$	-	40	-	ns
$E_{off}^{(1)}$	Turn-off switching energy	(see Figure 25. Test circuit for inductive load switching)	-	580	-	μJ
$t_{d(off)}$	Turn-off delay time	$V_{CC} = 400\text{ V}, I_C = 50\text{ A},$	-	135	-	ns
t_f	Current fall time	$V_{GE} = 15\text{ V}, R_G = 4.7\ \Omega,$	-	90	-	ns
$E_{off}^{(1)}$	Turn-off switching energy	$T_J = 175\text{ °C}$ (see Figure 25. Test circuit for inductive load switching)	-	1090	-	μJ

1. Including the tail of the collector current.

Table 6. Diode switching characteristics (inductive load)

Symbol	Parameter	Test conditions	Min.	Typ.	Max.	Unit
t_{rr}	Reverse recovery time	$I_F = 5\text{ A}$, $V_R = 400\text{ V}$, $V_{GE} = 15\text{ V}$, $di/dt = 1000\text{ A}/\mu\text{s}$ (see Figure 28. Diode reverse recovery waveform)	-	140	-	ns
Q_{rr}	Reverse recovery charge		-	21	-	nC
I_{rrm}	Reverse recovery current		-	6.6	-	A
di_{rr}/dt	Peak rate of fall of reverse recovery current during t_b		-	430	-	A/ μs
E_{rr}	Reverse recovery energy		-	1.6	-	μJ
t_{rr}	Reverse recovery time	$I_F = 5\text{ A}$, $V_R = 400\text{ V}$, $V_{GE} = 15\text{ V}$, $di/dt = 1000\text{ A}/\mu\text{s}$, $T_J = 175\text{ }^\circ\text{C}$ (see Figure 28. Diode reverse recovery waveform)	-	200	-	ns
Q_{rr}	Reverse recovery charge		-	47.3	-	nC
I_{rrm}	Reverse recovery current		-	9.6	-	A
di_{rr}/dt	Peak rate of fall of reverse recovery current during t_b		-	428	-	A/ μs
E_{rr}	Reverse recovery energy		-	3.2	-	μJ

2.1 Electrical characteristics (curves)

Figure 1. Power dissipation vs case temperature

Figure 2. Collector current vs case temperature

Figure 3. Output characteristics (T_J = 25 °C)

Figure 4. Output characteristics (T_J = 175 °C)

Figure 5. V_{CE(sat)} vs junction temperature

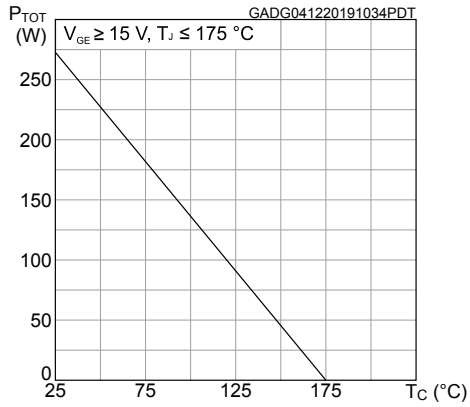
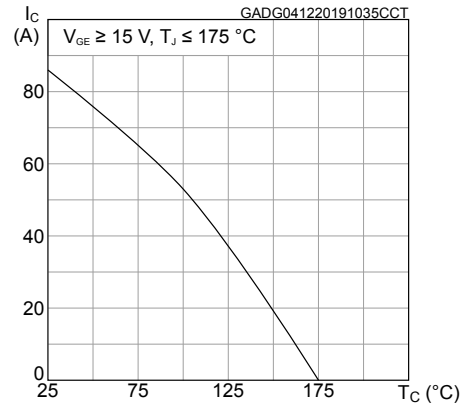
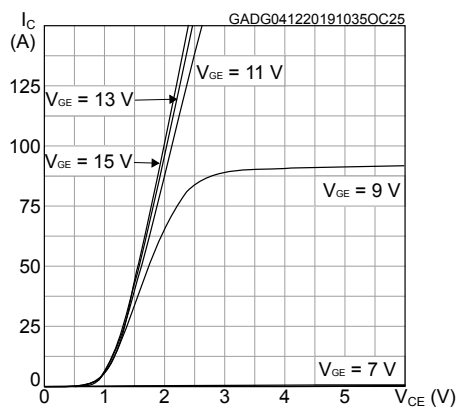
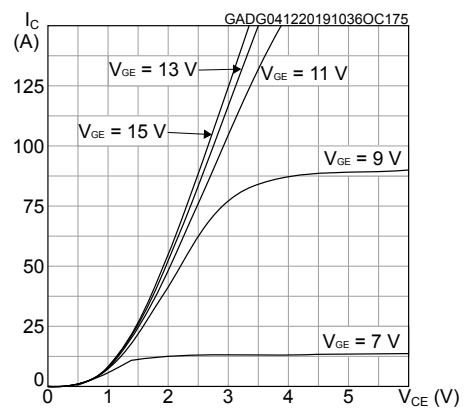
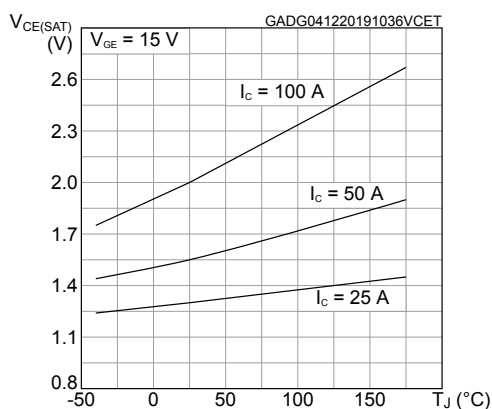
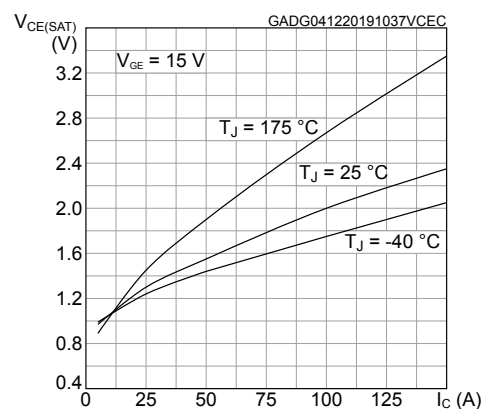
Figure 6. V_{CE(sat)} vs collector current

Figure 7. Forward bias safe operating area

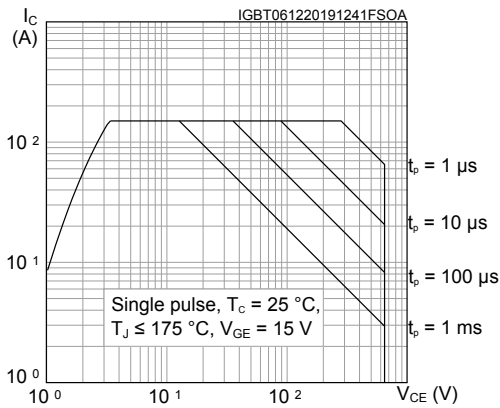

Figure 8. Transfer characteristics

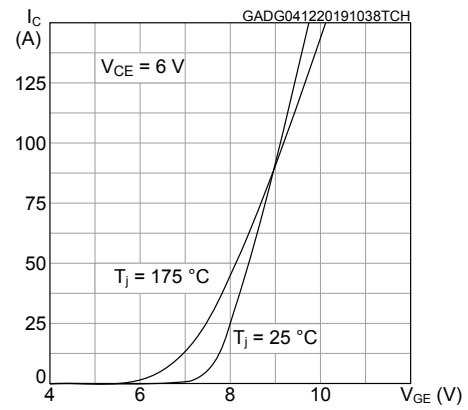

Figure 9. Normalized $V_{GE(th)}$ vs junction temperature

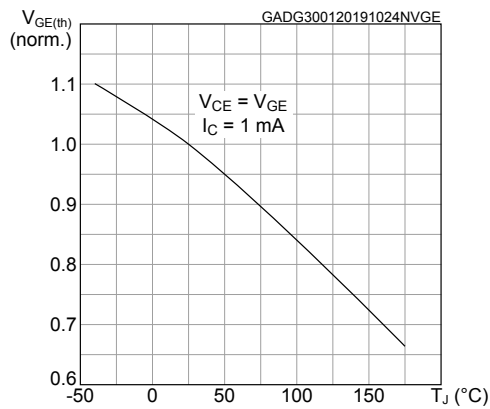

Figure 10. Normalized $V_{(BR)CES}$ vs junction temperature

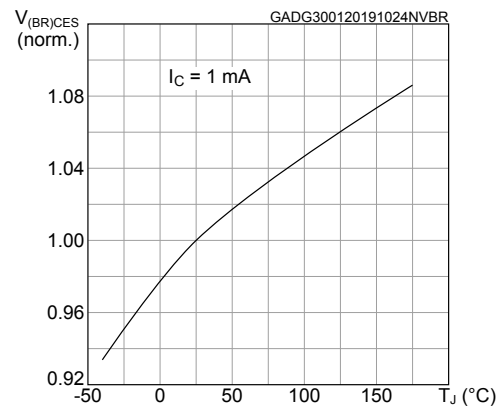

Figure 11. Capacitance variations

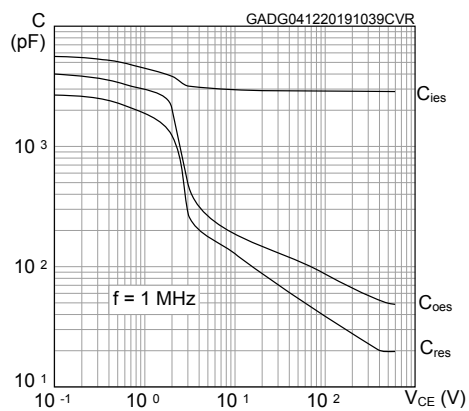

Figure 12. Gate charge vs gate-emitter voltage

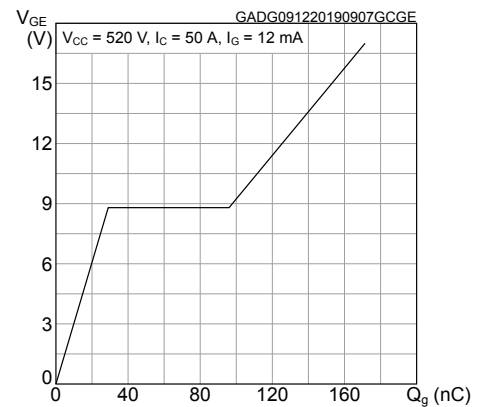

Figure 13. Switching energy vs collector current

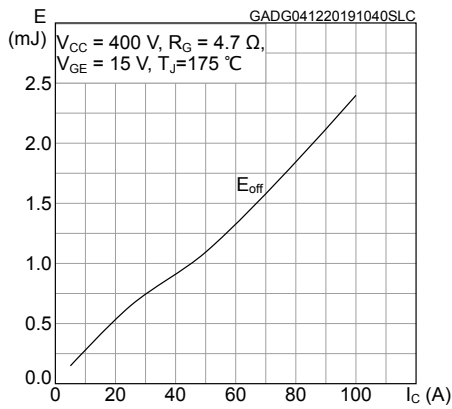

Figure 14. Switching energy vs temperature

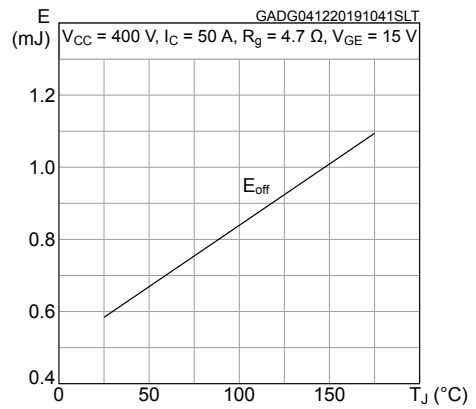

Figure 15. Switching energy vs collector emitter voltage

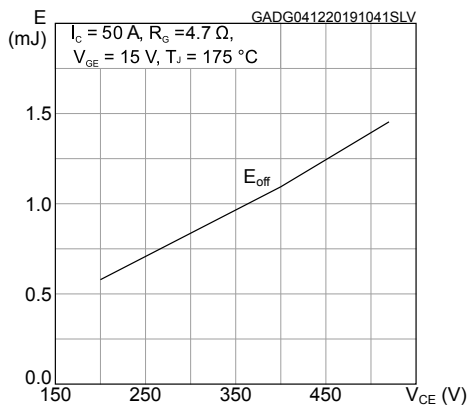

Figure 16. Switching energy vs gate resistance

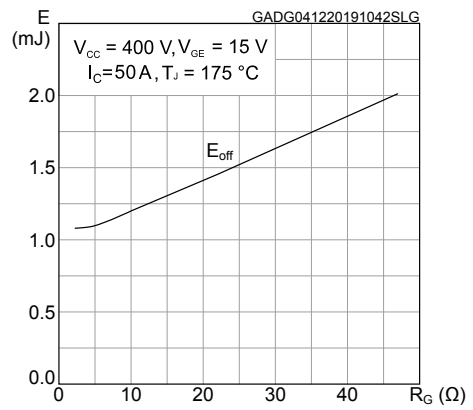

Figure 17. Switching times vs collector current

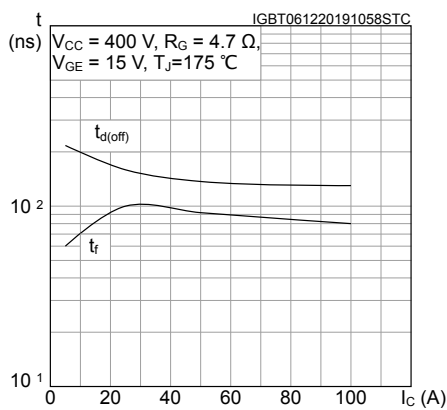

Figure 18. Switching times vs gate resistance

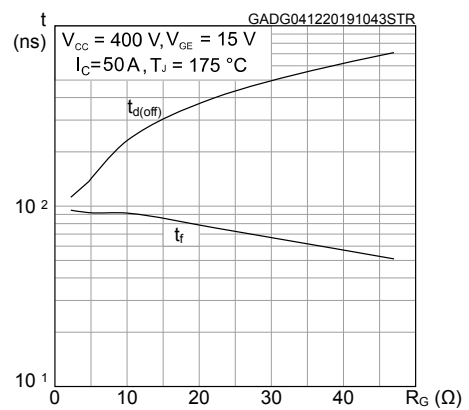

Figure 19. Reverse recovery current vs diode current slope

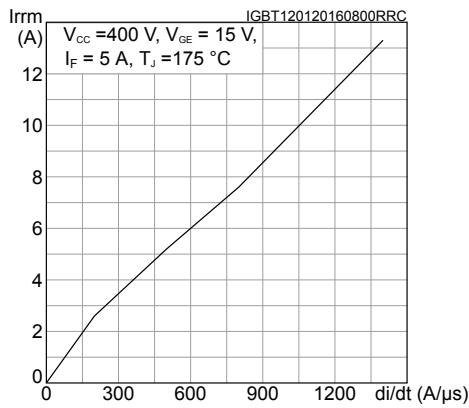

Figure 20. Reverse recovery time vs diode current slope

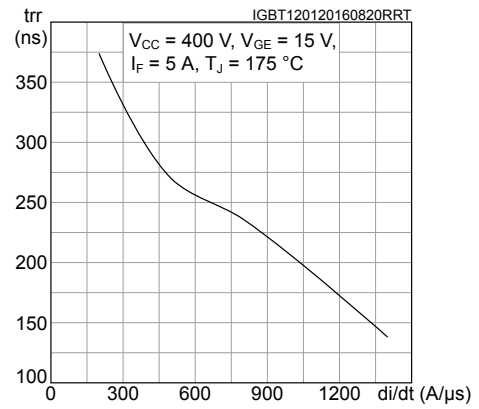

Figure 21. Reverse recovery charge vs diode current slope

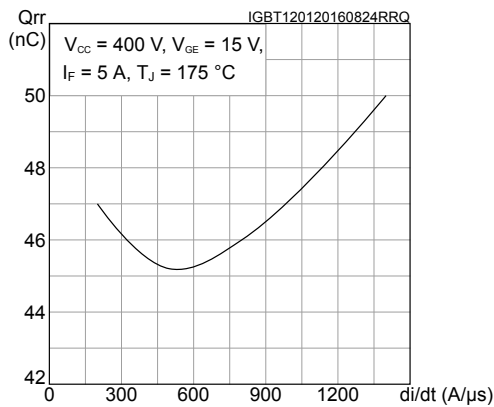

Figure 22. Reverse recovery energy vs diode current slope

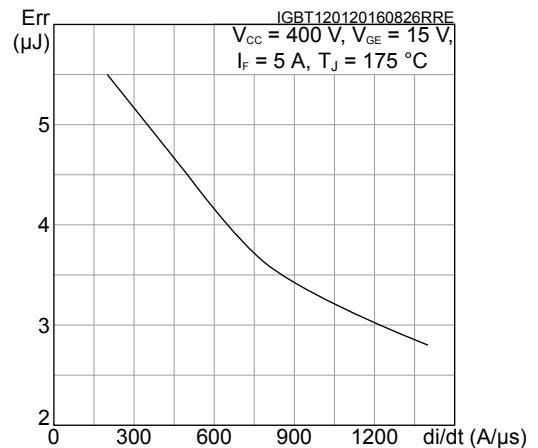

Figure 23. Thermal impedance for IGBT

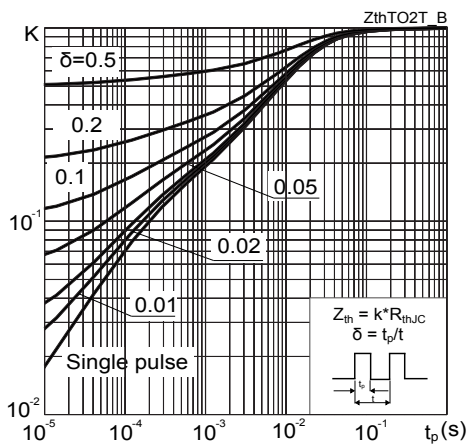
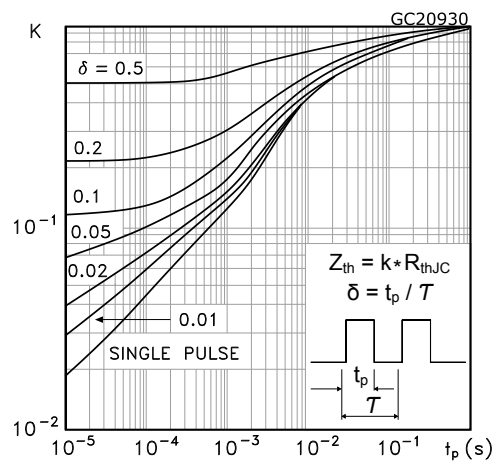
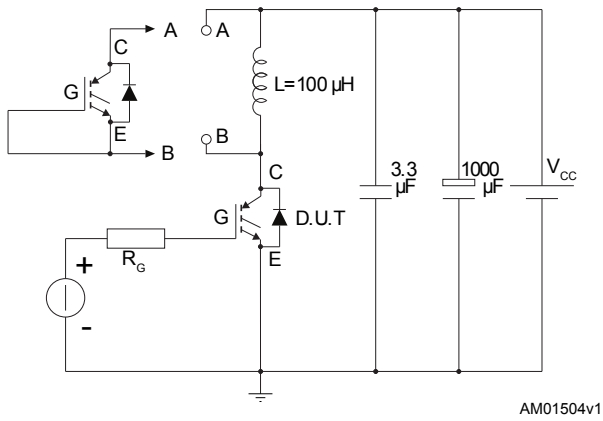
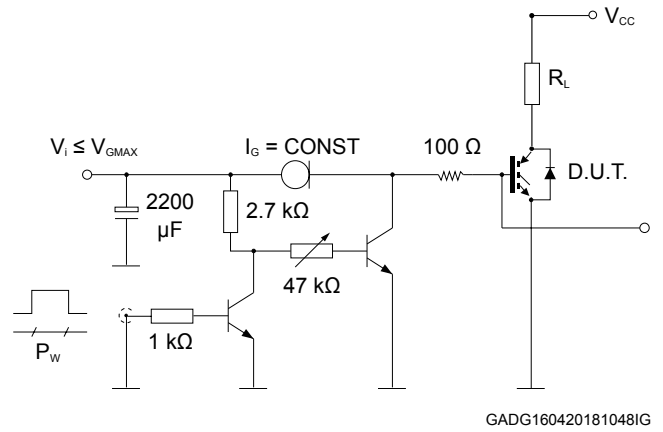
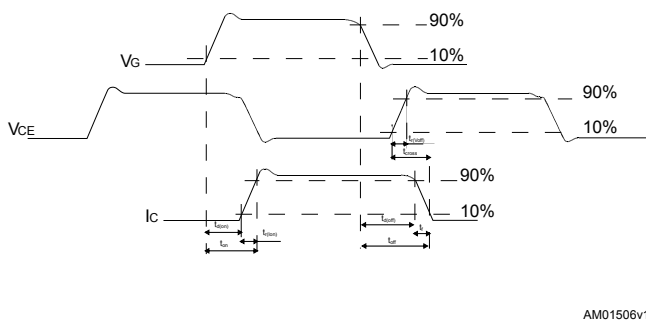
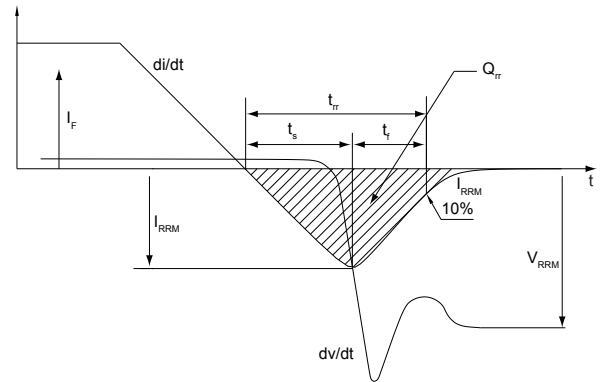

Figure 24. Thermal impedance for diode



3 Test circuits

Figure 25. Test circuit for inductive load switching

Figure 26. Gate charge test circuit

Figure 27. Switching waveform

Figure 28. Diode reverse recovery waveform

4 Package information

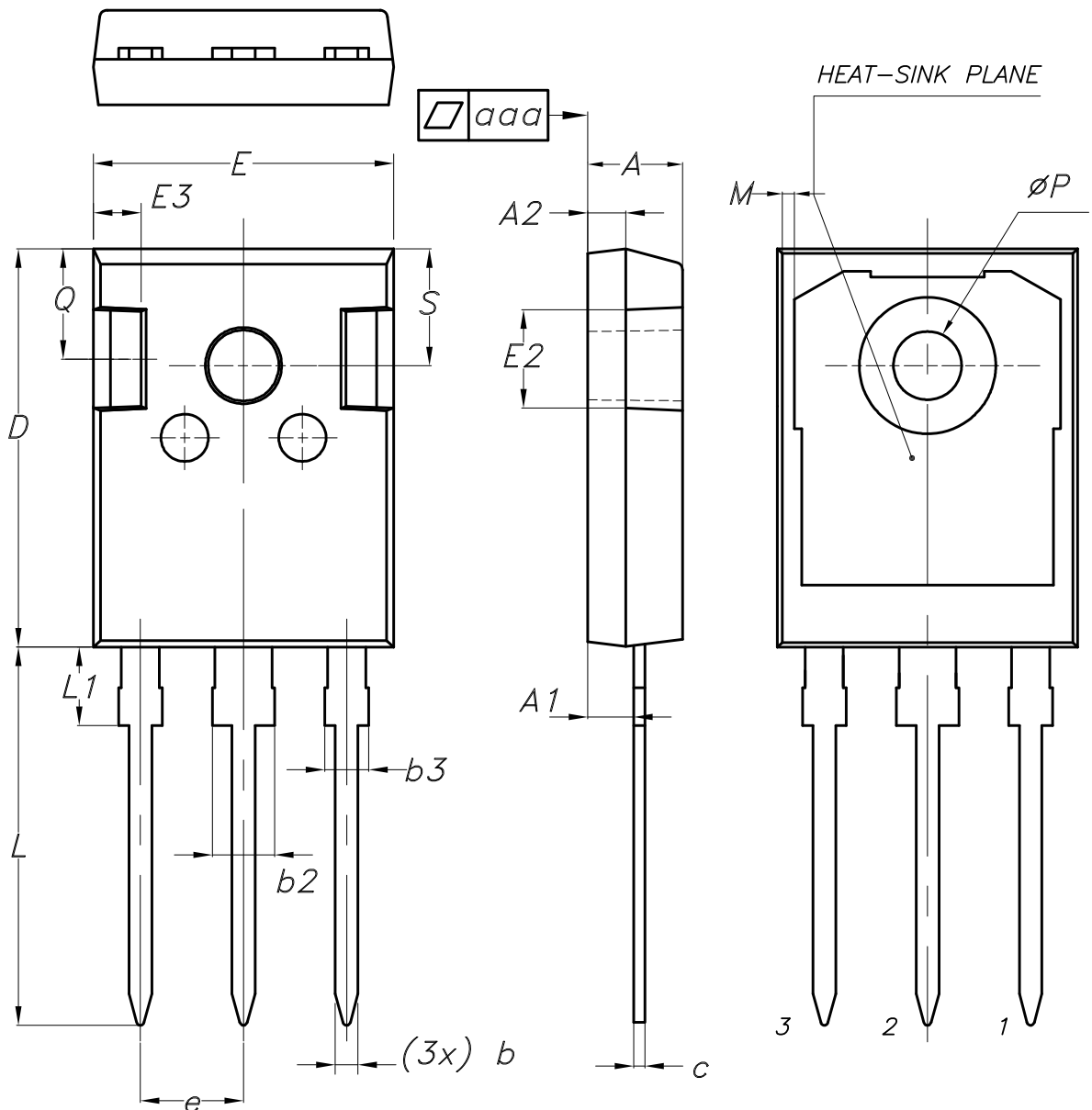
To meet environmental requirements, ST offers these devices in different grades of **ECOPACK** packages, depending on their level of environmental compliance. ECOPACK specifications, grade definitions, and product status are available at: www.st.com. ECOPACK is an ST trademark.

4.1 TO-247 long leads package information

Figure 29. TO-247 long leads package outline



BACK VIEW

8463846_5

Table 7. TO-247 long leads package mechanical data

Dim.	mm		
	Min.	Typ.	Max.
A	4.90	5.00	5.10
A1	2.31	2.41	2.51
A2	1.90	2.00	2.10
b	1.16		1.26
b2			3.25
b3			2.25
c	0.59		0.66
D	20.90	21.00	21.10
E	15.70	15.80	15.90
E2	4.90	5.00	5.10
E3	2.40	2.50	2.60
e	5.34	5.44	5.54
L	19.80	19.92	20.10
L1			4.30
M	0.35		0.95
P	3.50	3.60	3.70
Q	5.60		6.00
S	6.05	6.15	6.25
aaa		0.04	0.10

Revision history

Table 8. Document revision history

Date	Version	Changes
05-Dec-2019	1	First release.
03-Oct-2024	2	Updated <i>Section 4.1: TO-247 long leads package information</i> . Minor text changes
21-Nov-2024	3	Updated Table 3. Static characteristics . Removed figure <i>Diode V_F vs forward current</i>

Contents

1	Electrical ratings	2
2	Electrical characteristics	3
2.1	Electrical characteristics (curves)	5
3	Test circuits	9
4	Package information	10
4.1	TO-247 long leads package information	10
	Revision history	12

IMPORTANT NOTICE – READ CAREFULLY

STMicroelectronics NV and its subsidiaries (“ST”) reserve the right to make changes, corrections, enhancements, modifications, and improvements to ST products and/or to this document at any time without notice. Purchasers should obtain the latest relevant information on ST products before placing orders. ST products are sold pursuant to ST’s terms and conditions of sale in place at the time of order acknowledgment.

Purchasers are solely responsible for the choice, selection, and use of ST products and ST assumes no liability for application assistance or the design of purchasers’ products.

No license, express or implied, to any intellectual property right is granted by ST herein.

Resale of ST products with provisions different from the information set forth herein shall void any warranty granted by ST for such product.

ST and the ST logo are trademarks of ST. For additional information about ST trademarks, refer to www.st.com/trademarks. All other product or service names are the property of their respective owners.

Information in this document supersedes and replaces information previously supplied in any prior versions of this document.

© 2024 STMicroelectronics – All rights reserved