

## Trench gate field-stop IGBT, HB series 650 V, 80 A high speed

Datasheet - obsolete product

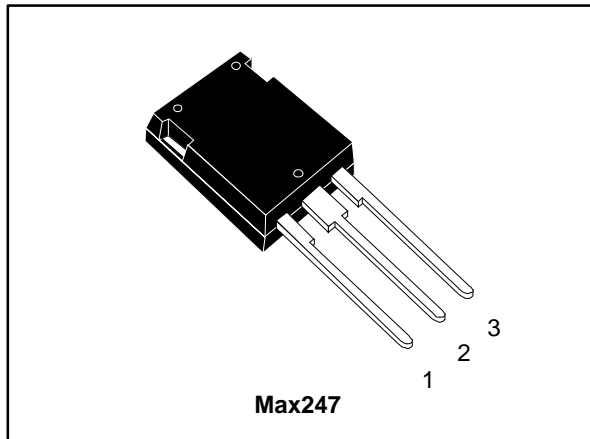
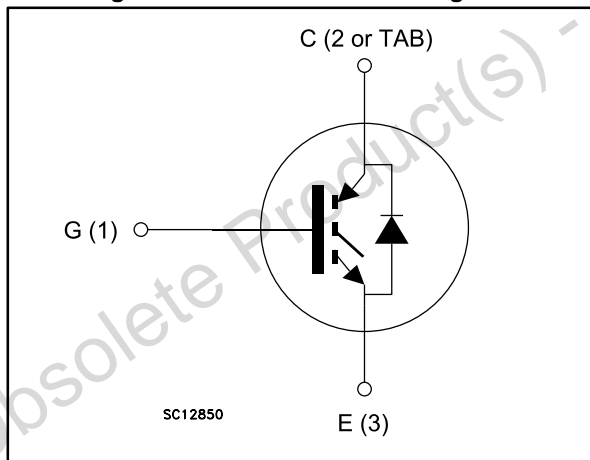

Figure 1: Internal schematic diagram



### Features

- Maximum junction temperature:  $T_J = 175\text{ }^\circ\text{C}$
- High speed switching series
- Minimized tail current
- $V_{CE(sat)} = 1.6\text{ V(}typ\text{)} @ I_C = 80\text{ A}$
- Safe paralleling
- Tight parameter distribution
- Low thermal resistance
- Very fast soft recovery antiparallel diode

### Applications

- Photovoltaic inverters
- High frequency converters

### Description

This device is an IGBT developed using an advanced proprietary trench gate field-stop structure. The device is part of the new HB series of IGBTs, which represents an optimum compromise between conduction and switching loss to maximize the efficiency of any frequency converter. Furthermore, the slightly positive  $V_{CE(sat)}$  temperature coefficient and very tight parameter distribution result in safer paralleling operation.

Table 1: Device summary

Order code	Marking	Package	Packing
STGY80H65DFB	GY80H65DFB	Max247	Tube

---

**Contents**

<b>1</b>	<b>Electrical ratings .....</b>	<b>3</b>
<b>2</b>	<b>Electrical characteristics .....</b>	<b>4</b>
	2.1 Electrical characteristics (curves) .....	6
<b>3</b>	<b>Test circuits .....</b>	<b>11</b>
<b>4</b>	<b>Package information .....</b>	<b>12</b>
	4.1 Max247 package information .....	12
<b>5</b>	<b>Revision history .....</b>	<b>14</b>

Obsolete Product(s) - Obsolete Product(s)

# 1 Electrical ratings

**Table 2: Absolute maximum ratings**

Symbol	Parameter	Value	Unit
$V_{CES}$	Collector-emitter voltage ( $V_{GE} = 0$ V)	650	V
$I_C$	Continuous collector current at $T_C = 25$ °C	120 <sup>(1)</sup>	A
	Continuous collector current at $T_C = 100$ °C	80	
$I_{CP}$ <sup>(2)</sup>	Pulsed collector current	240	A
$V_{GE}$	Gate-emitter voltage	± 20	V
$I_F$	Continuous forward current at $T_C = 25$ °C	120 <sup>(1)</sup>	A
	Continuous forward current at $T_C = 100$ °C	80	
$I_{FP}$ <sup>(2)</sup>	Pulsed forward current	240	A
$P_{TOT}$	Total dissipation at $T_C = 25$ °C	469	W
$T_{STG}$	Storage temperature range	- 55 to 150	°C
$T_J$	Operating junction temperature range	- 55 to 175	

**Notes:**

<sup>(1)</sup>Current level is limited by bond wires

<sup>(2)</sup>Pulse width limited by maximum junction temperature.

**Table 3: Thermal data**

Symbol	Parameter	Value	Unit
$R_{thJC}$	Thermal resistance junction-case IGBT	0.32	°C/W
$R_{thJC}$	Thermal resistance junction-case diode	0.66	
$R_{thJA}$	Thermal resistance junction-ambient	50	

## 2 Electrical characteristics

$T_C = 25\text{ °C}$  unless otherwise specified

**Table 4: Static characteristics**

Symbol	Parameter	Test conditions	Min.	Typ.	Max.	Unit
$V_{(BR)CES}$	Collector-emitter breakdown voltage	$V_{GE} = 0\text{ V}$ , $I_C = 2\text{ mA}$	650			V
$V_{CE(sat)}$	Collector-emitter saturation voltage	$V_{GE} = 15\text{ V}$ , $I_C = 80\text{ A}$		1.6	2	V
		$V_{GE} = 15\text{ V}$ , $I_C = 80\text{ A}$ , $T_J = 125\text{ °C}$		1.8		
		$V_{GE} = 15\text{ V}$ , $I_C = 80\text{ A}$ , $T_J = 175\text{ °C}$		1.9		
$V_F$	Forward on-voltage	$I_F = 80\text{ A}$		1.9	2.3	V
		$I_F = 80\text{ A}$ , $T_J = 125\text{ °C}$		1.6		
		$I_F = 80\text{ A}$ , $T_J = 175\text{ °C}$		1.5		
$V_{GE(th)}$	Gate threshold voltage	$V_{CE} = V_{GE}$ , $I_C = 1\text{ mA}$	5	6	7	V
$I_{CES}$	Collector cut-off current	$V_{GE} = 0\text{ V}$ , $V_{CE} = 650\text{ V}$			100	$\mu\text{A}$
$I_{GES}$	Gate-emitter leakage current	$V_{CE} = 0\text{ V}$ , $V_{GE} = \pm 20\text{ V}$			$\pm 250$	nA

**Table 5: Dynamic characteristics**

Symbol	Parameter	Test conditions	Min.	Typ.	Max.	Unit
$C_{ies}$	Input capacitance	$V_{CE} = 25\text{ V}$ , $f = 1\text{ MHz}$ , $V_{GE} = 0\text{ V}$	-	10524	-	pF
$C_{oes}$	Output capacitance		-	385	-	
$C_{res}$	Reverse transfer capacitance		-	215	-	
$Q_g$	Total gate charge	$V_{CC} = 520\text{ V}$ , $I_C = 80\text{ A}$ , $V_{GE} = 15\text{ V}$ (see <a href="#">Figure 29: "Gate charge test circuit"</a> )	-	414	-	nC
$Q_{ge}$	Gate-emitter charge		-	78	-	
$Q_{gc}$	Gate-collector charge		-	170	-	

Table 6: IGBT switching characteristics (inductive load)

Symbol	Parameter	Test conditions	Min.	Typ.	Max.	Unit
$t_{d(on)}$	Turn-on delay time	$V_{CE} = 400\text{ V}$ , $I_C = 80\text{ A}$ , $V_{GE} = 15\text{ V}$ , $R_G = 10\ \Omega$ (see <a href="#">Figure 28: "Test circuit for inductive load switching"</a> )	-	84	-	ns
$t_r$	Current rise time		-	52	-	ns
$(di/dt)_{on}$	Turn-on current slope		-	1270	-	A/ $\mu$ s
$t_{d(off)}$	Turn-off-delay time		-	280	-	ns
$t_f$	Current fall time		-	31	-	ns
$E_{on}^{(1)}$	Turn-on switching energy		-	2.1	-	mJ
$E_{off}^{(2)}$	Turn-off switching energy		-	1.5	-	mJ
$E_{ts}$	Total switching energy		-	3.6	-	mJ
$t_{d(on)}$	Turn-on delay time	$V_{CE} = 400\text{ V}$ , $I_C = 80\text{ A}$ , $V_{GE} = 15\text{ V}$ , $R_G = 10\ \Omega$ , $T_J = 175\text{ }^\circ\text{C}$ (see <a href="#">Figure 28: "Test circuit for inductive load switching"</a> )	-	77	-	ns
$t_r$	Current rise time		-	51	-	ns
$(di/dt)_{on}$	Turn-on current slope		-	1270	-	A/ $\mu$ s
$t_{d(off)}$	Turn-off-delay time		-	328	-	ns
$t_f$	Current fall time		-	30	-	ns
$E_{on}^{(1)}$	Turn-on switching energy		-	4.4	-	mJ
$E_{off}^{(2)}$	Turn-off switching energy		-	2.1	-	mJ
$E_{ts}$	Total switching energy		-	6.5	-	mJ

**Notes:**

(1)Including the reverse recovery of the diode.

(2)Including the tail of the collector current.

Table 7: Diode switching characteristics (inductive load)

Symbol	Parameter	Test conditions	Min.	Typ.	Max.	Unit
$t_{rr}$	Reverse recovery time	$I_F = 80\text{ A}$ , $V_R = 400\text{ V}$ , $di/dt = 1000\text{ A}/\mu\text{s}$ $V_{GE} = 15\text{ V}$ , (see <a href="#">Figure 28: "Test circuit for inductive load switching"</a> )	-	85	-	ns
$Q_{rr}$	Reverse recovery charge		-	1105	-	nC
$I_{rrm}$	Reverse recovery current		-	26	-	A
$dl_{rr}/dt$	Peak rate of fall of reverse recovery current during $t_b$		-	722	-	A/ $\mu$ s
$E_{rr}$	Reverse recovery energy		-	267	-	$\mu$ J
$t_{rr}$	Reverse recovery time	$I_F = 80\text{ A}$ , $V_R = 400\text{ V}$ , $V_{GE} = 15\text{ V}$ , $T_J = 175\text{ }^\circ\text{C}$ $di/dt = 1000\text{ A}/\mu\text{s}$ (see <a href="#">Figure 28: "Test circuit for inductive load switching"</a> )	-	149	-	ns
$Q_{rr}$	Reverse recovery charge		-	4920	-	nC
$I_{rrm}$	Reverse recovery current		-	66	-	A
$dl_{rr}/dt$	Peak rate of fall of reverse recovery current during $t_b$		-	546	-	A/ $\mu$ s
$E_{rr}$	Reverse recovery energy		-	1172	-	$\mu$ J

### 2.1 Electrical characteristics (curves)

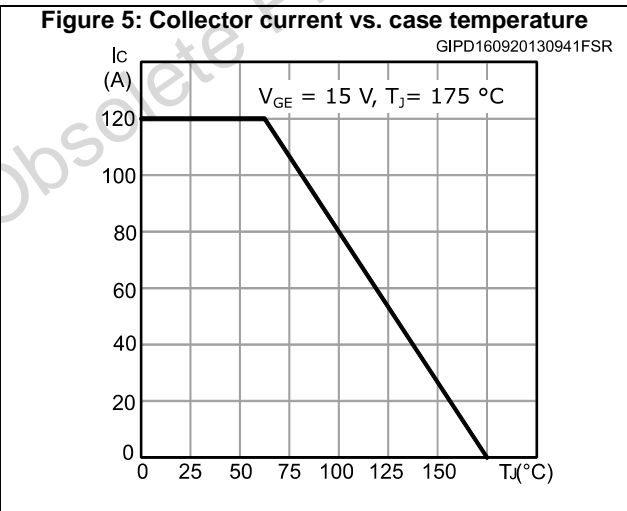
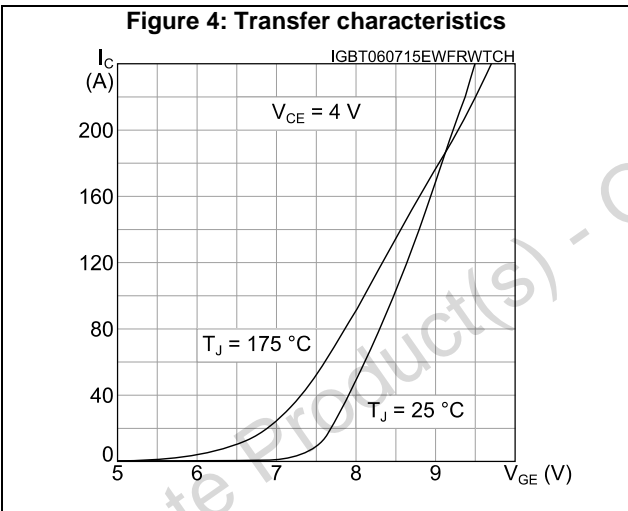
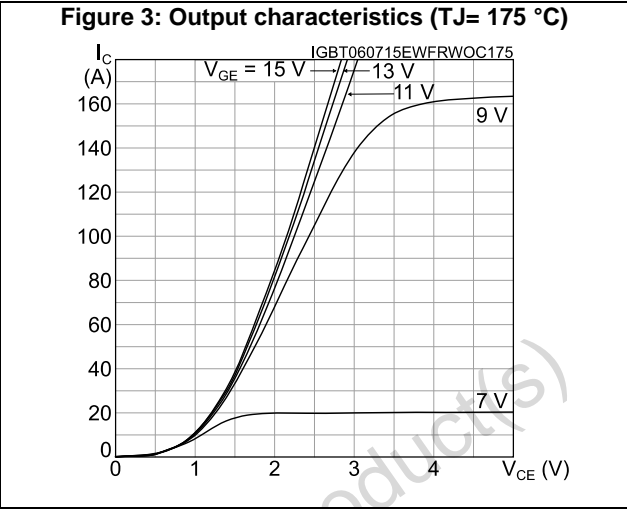
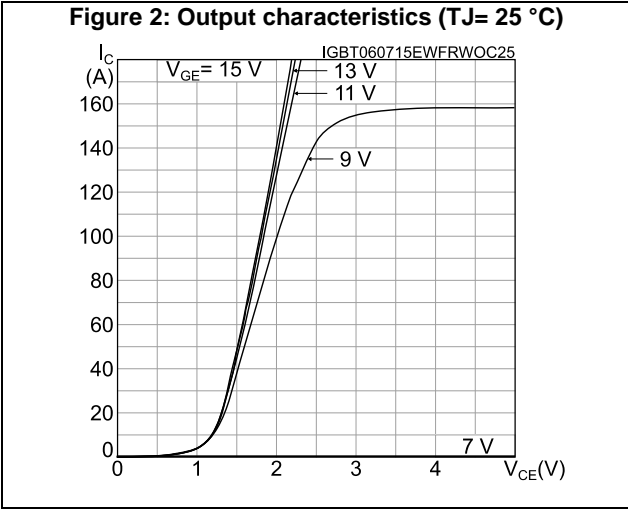

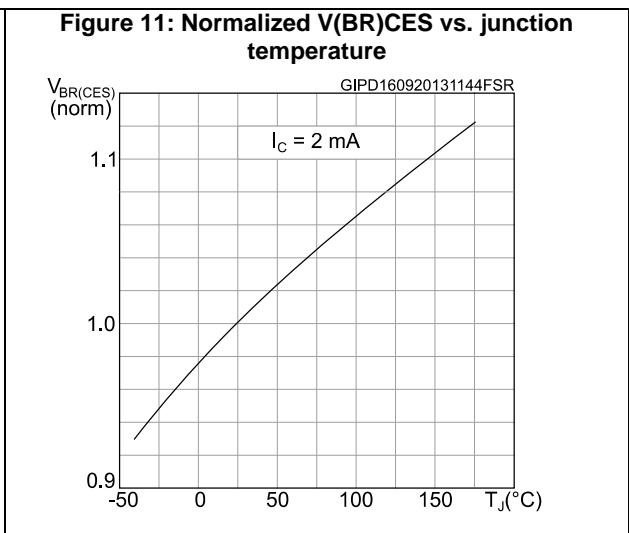
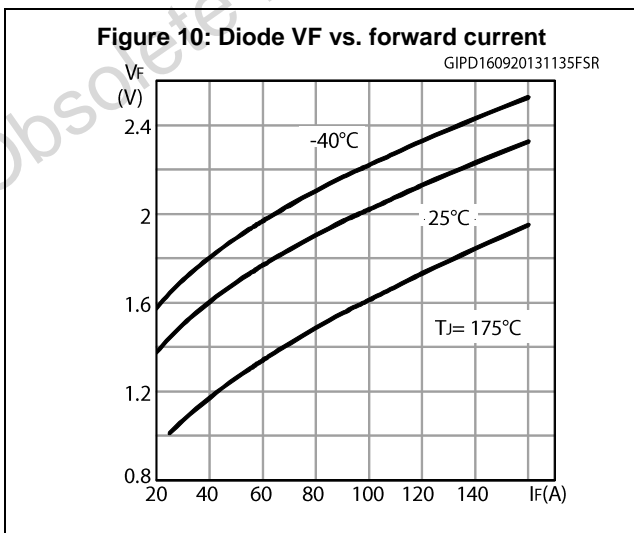
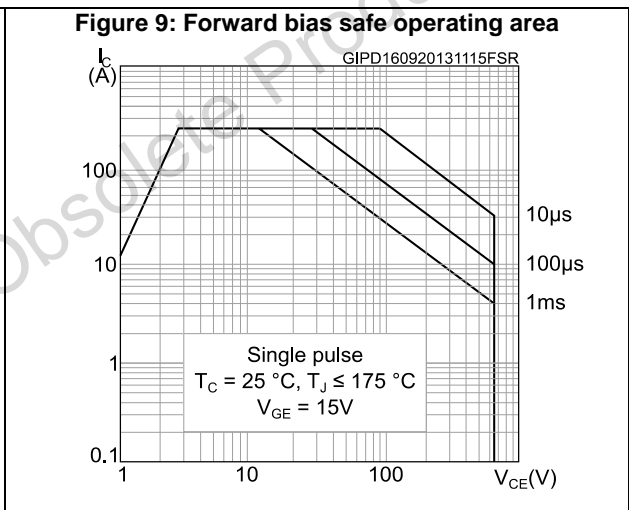
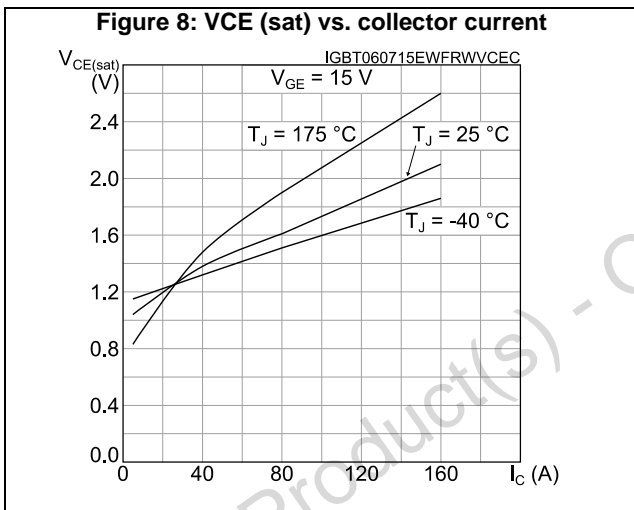
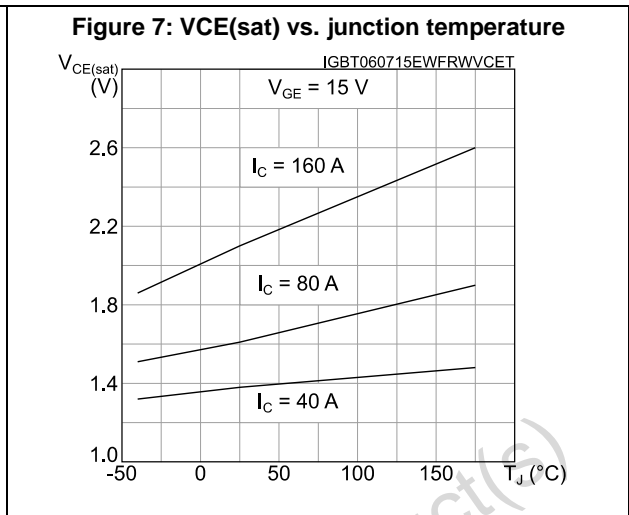
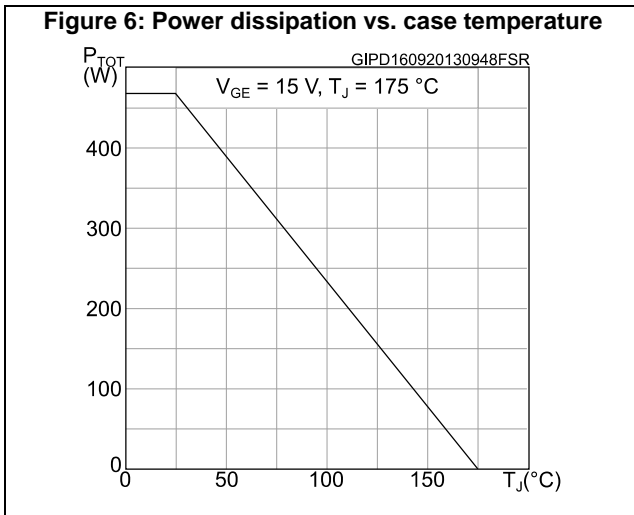

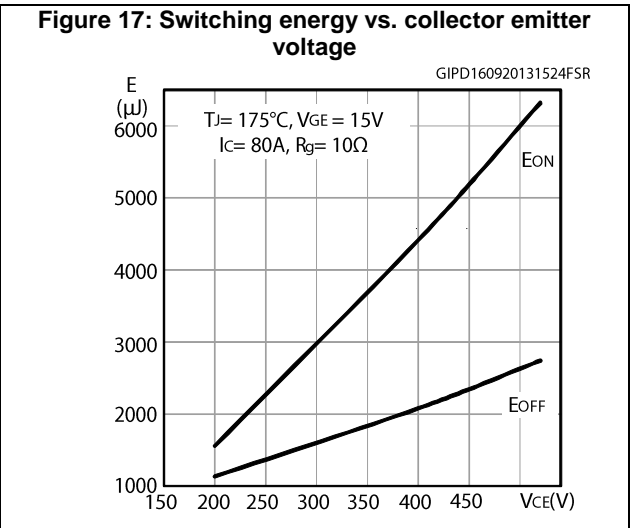
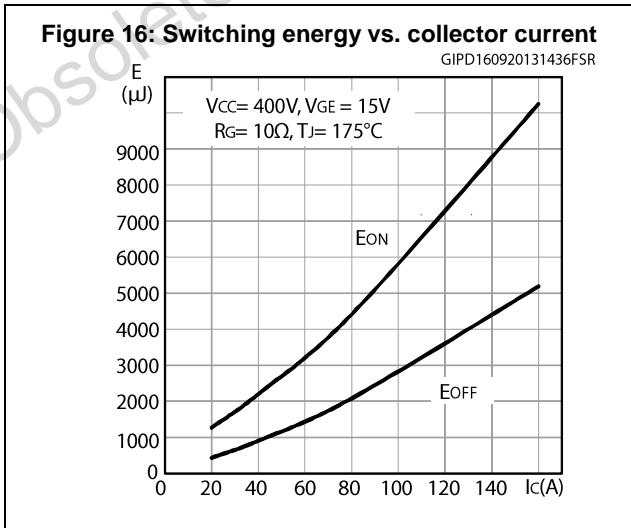
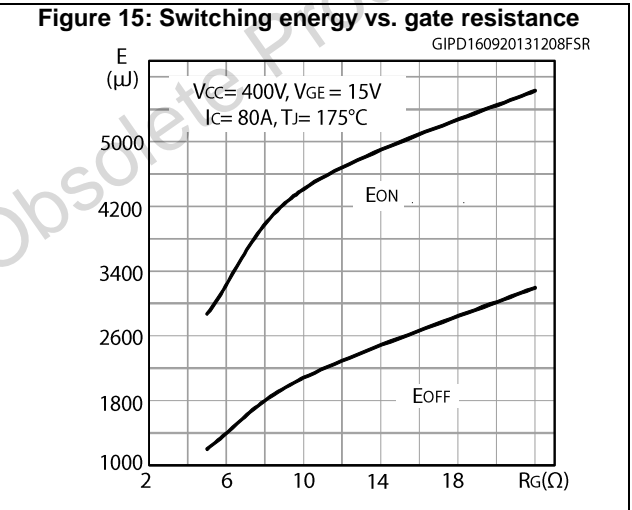
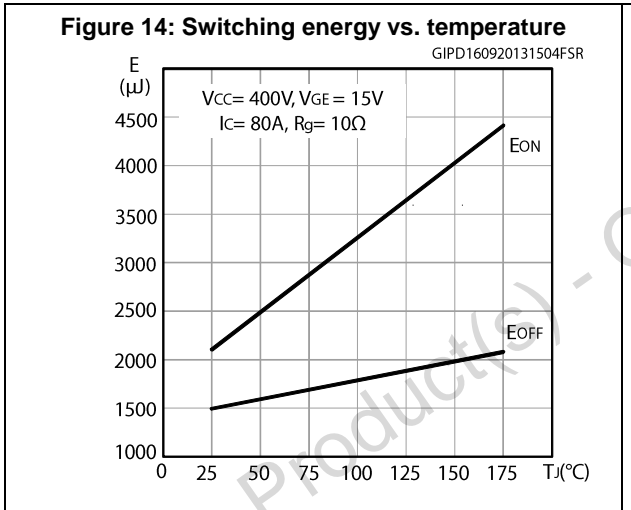
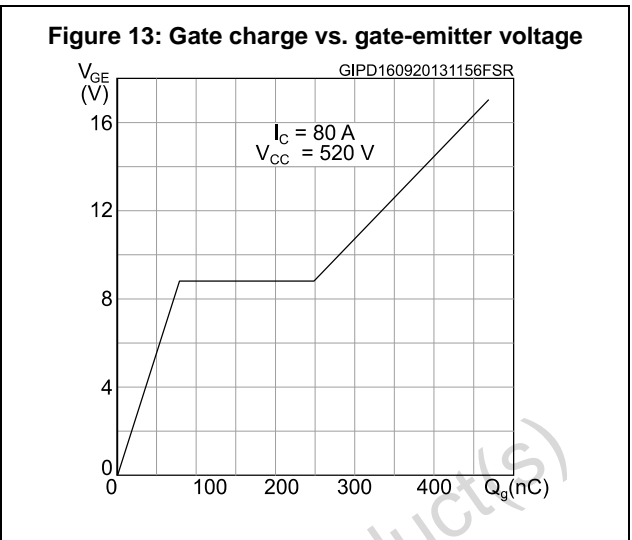
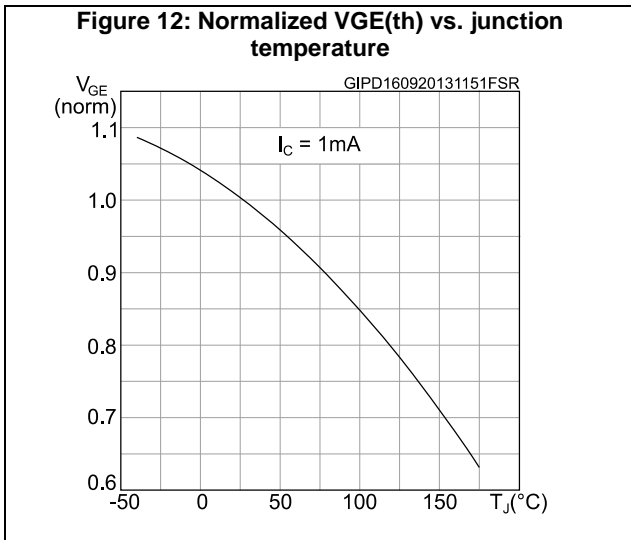



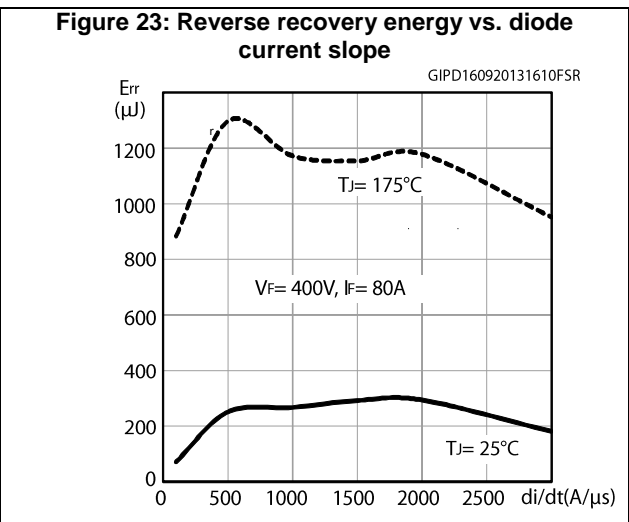
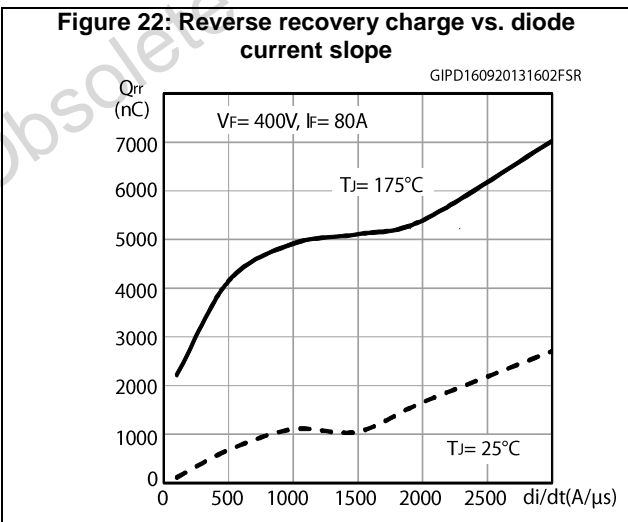
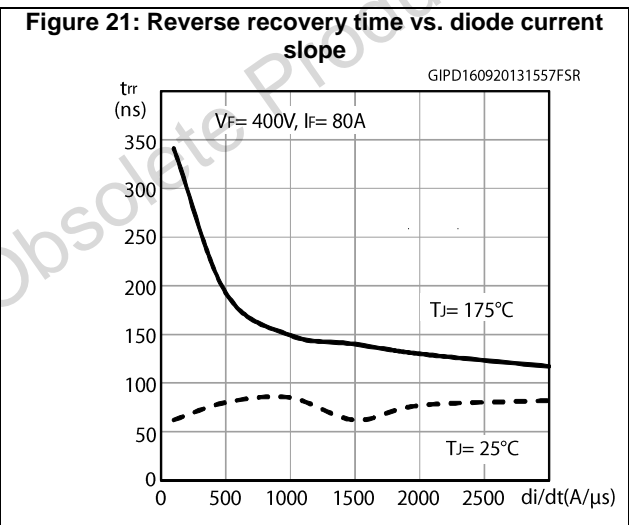
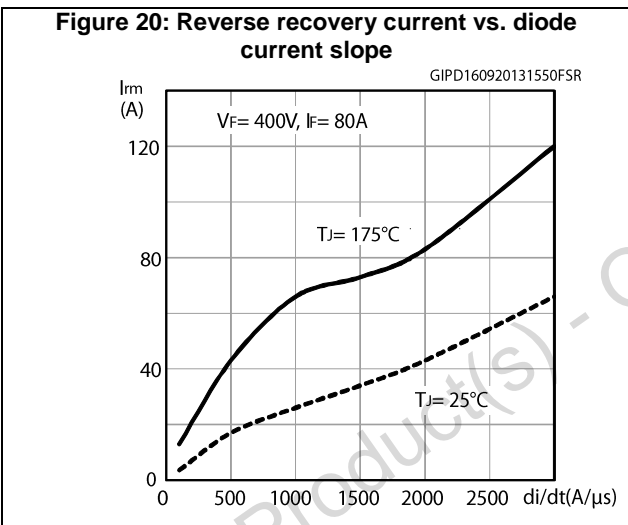
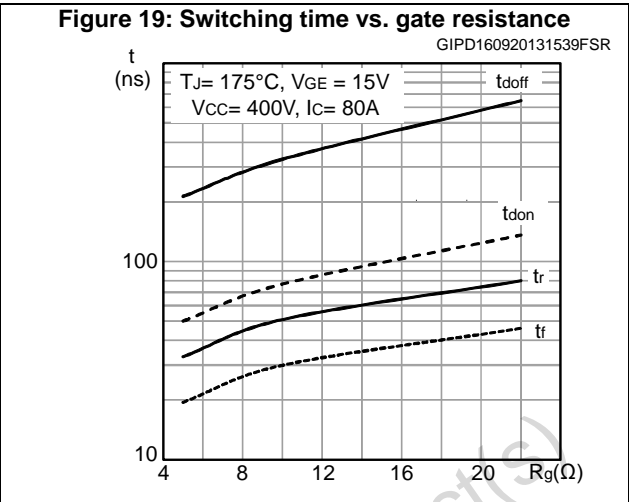
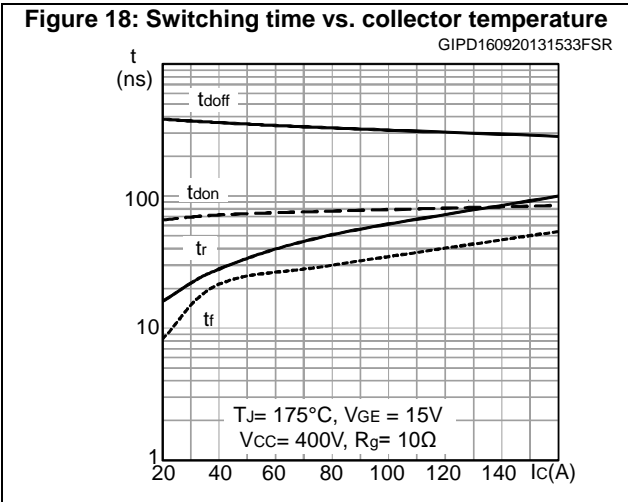

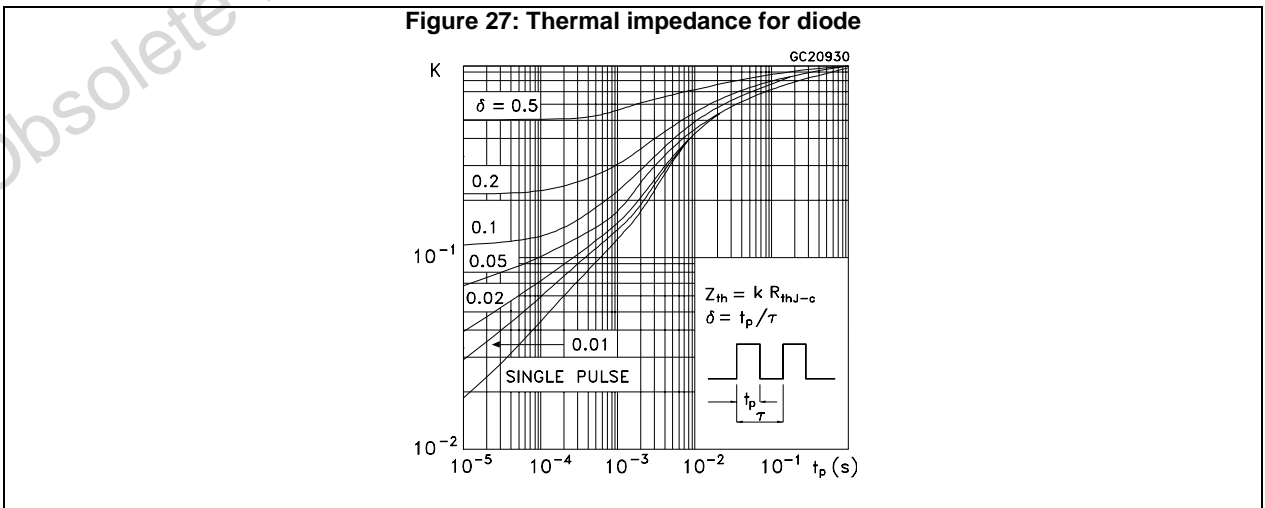
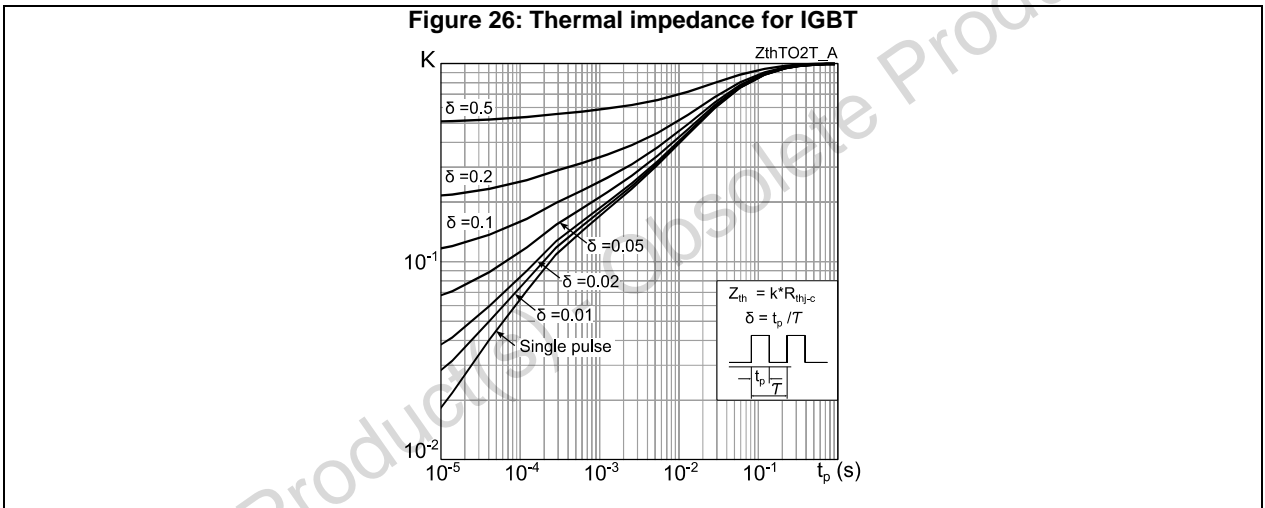
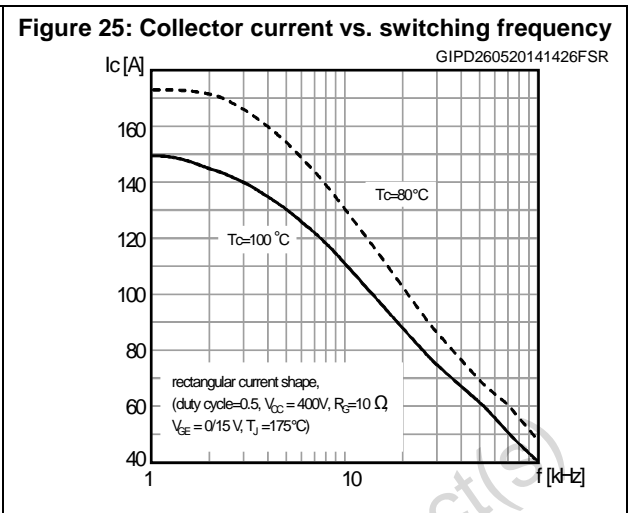
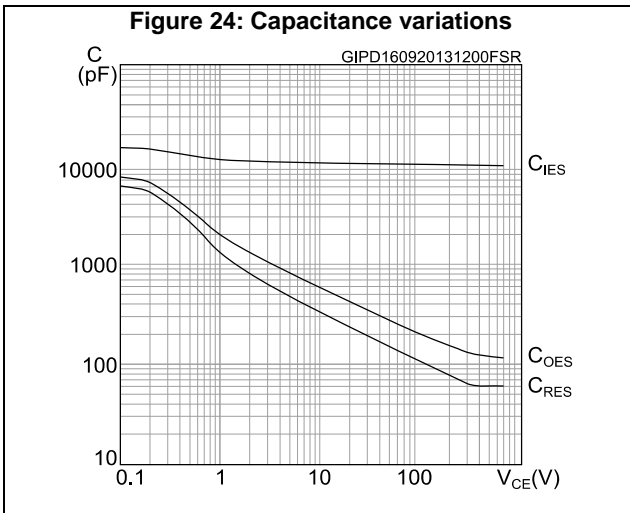

### 3 Test circuits

Figure 28: Test circuit for inductive load switching

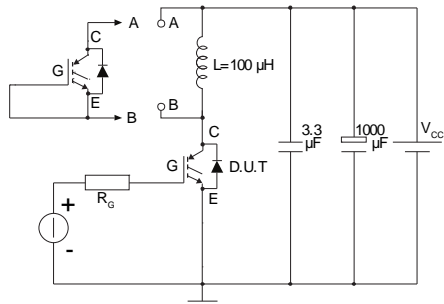

AM01504v1

Figure 29: Gate charge test circuit

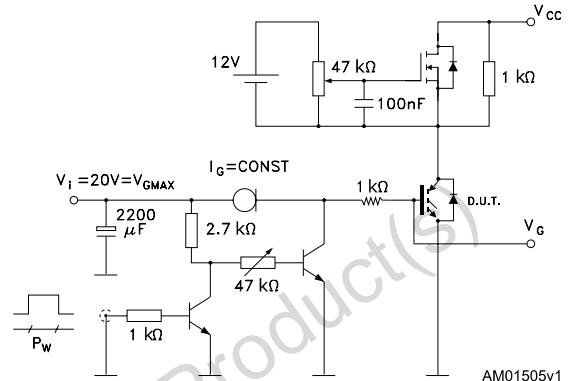

AM01505v1

Figure 30: Switching waveform

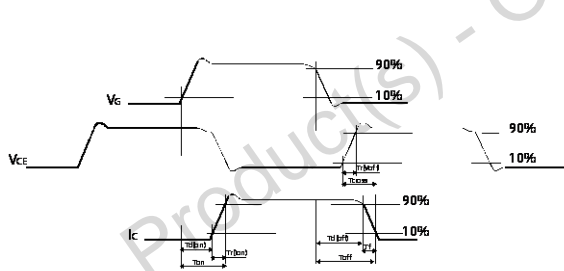

AM01506v1

Figure 31: Diode reverse recovery waveform

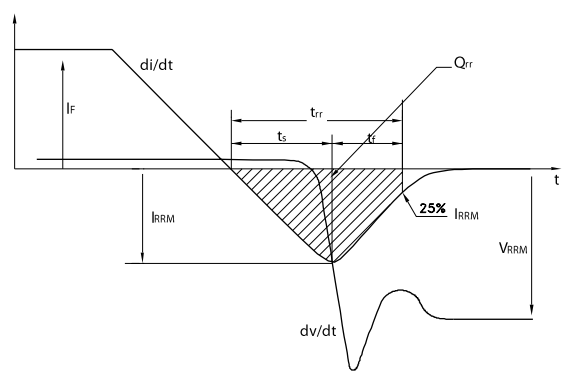

AM01507v1

## 4 Package information

In order to meet environmental requirements, ST offers these devices in different grades of ECOPACK® packages, depending on their level of environmental compliance. ECOPACK® specifications, grade definitions and product status are available at: [www.st.com](http://www.st.com). ECOPACK® is an ST trademark.

### 4.1 Max247 package information

Figure 32: Max247 package outline

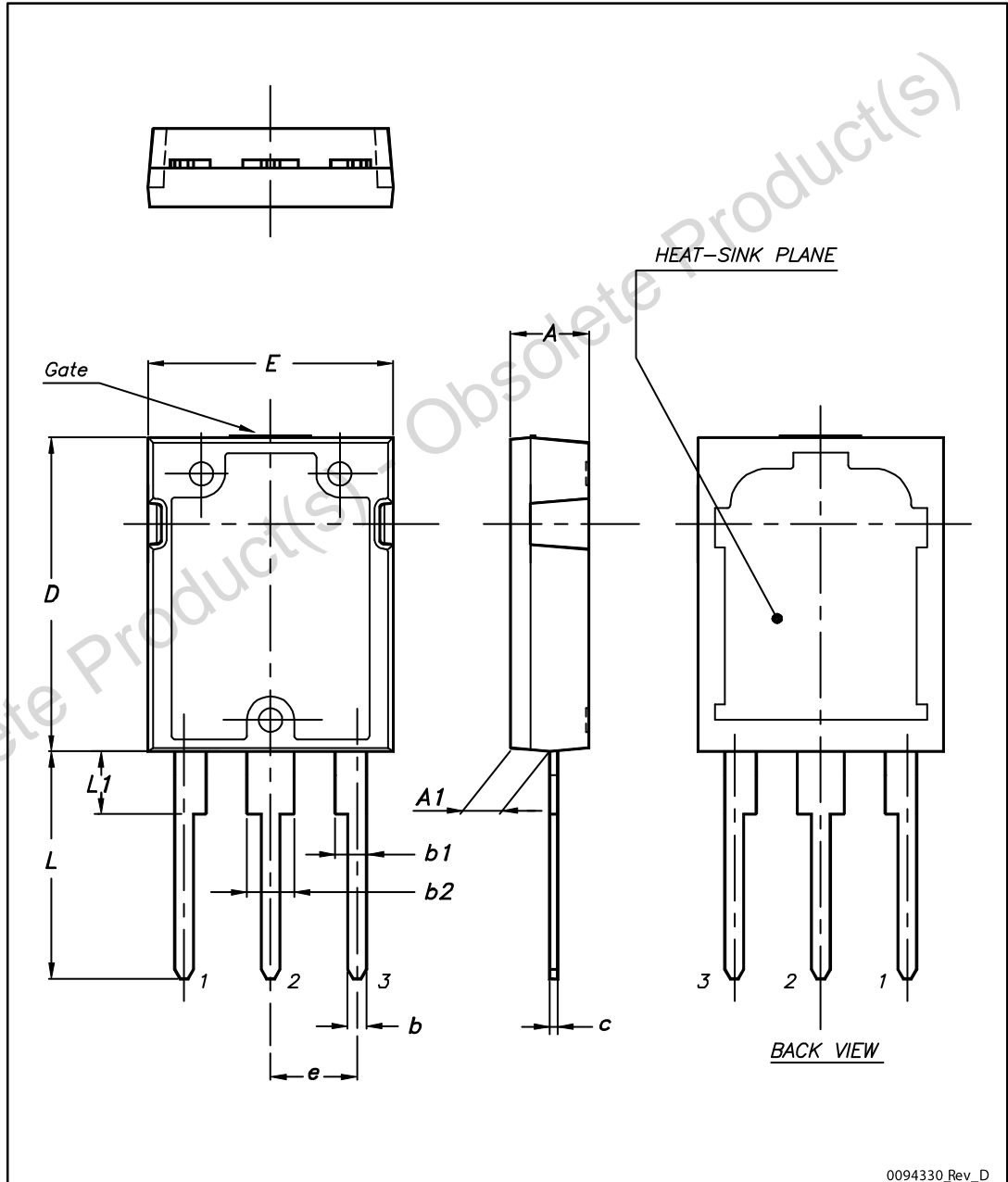

Table 8: Max247 package mechanical data

Dim.	mm		
	Min.	Typ.	Max.
A	4.70	-	5.30
A1	2.20	-	2.60
b	1.00	-	1.40
b1	2.00	-	2.40
b2	3.00	-	3.40
c	0.40	-	0.80
D	19.70	-	20.30
e	5.35	-	5.55
E	15.30	-	15.90
L	14.20	-	15.20
L1	3.70	-	4.30

## 5 Revision history

**Table 9: Document revision history**

Date	Revision	Changes
12-Oct-2016	1	First release, The part number STGY80H65DFB previously included in DS DocID024366.

Obsolete Product(s) - Obsolete Product(s)

**IMPORTANT NOTICE – PLEASE READ CAREFULLY**

STMicroelectronics NV and its subsidiaries ("ST") reserve the right to make changes, corrections, enhancements, modifications, and improvements to ST products and/or to this document at any time without notice. Purchasers should obtain the latest relevant information on ST products before placing orders. ST products are sold pursuant to ST's terms and conditions of sale in place at the time of order acknowledgement.

Purchasers are solely responsible for the choice, selection, and use of ST products and ST assumes no liability for application assistance or the design of Purchasers' products.

No license, express or implied, to any intellectual property right is granted by ST herein.

Resale of ST products with provisions different from the information set forth herein shall void any warranty granted by ST for such product.

ST and the ST logo are trademarks of ST. All other product or service names are the property of their respective owners.

Information in this document supersedes and replaces information previously supplied in any prior versions of this document.

© 2016 STMicroelectronics – All rights reserved