

Automotive-grade N-channel 40 V, 2.1 mΩ typ., 120 A STripFET™ F3 Power MOSFET in an I²PAK package

Datasheet - production data

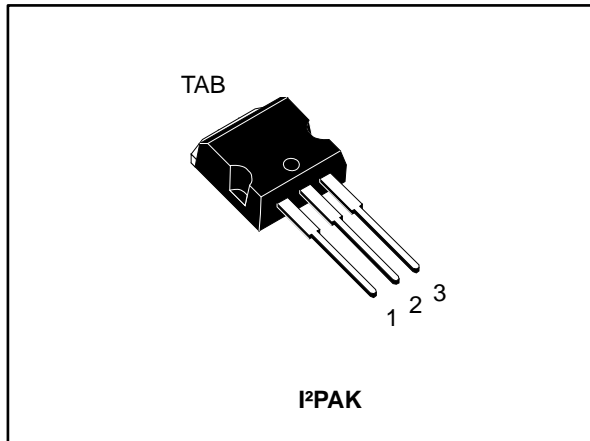
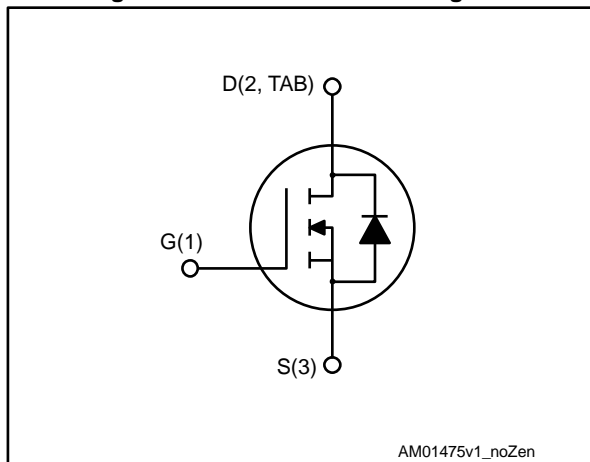

Figure 1: Internal schematic diagram



Features

Order code	V _{DS}	R _{DS(on)} max.	I _D	P _{TOT}
STI270N4F3	40 V	2.6 mΩ	120 A	330 W



- AEC-Q101 qualified
- Ultra low on-resistance
- 100% avalanche tested

Applications

- Switching applications

Description

This device is an N-channel Power MOSFET developed using STripFET™ F3 technology. It is designed to minimize on-resistance and gate charge to provide superior switching performance.

Table 1: Device summary

Order code	Marking	Package	Packing
STI270N4F3	270N4F3	I ² PAK	Tube

Contents

1	Electrical ratings	3
2	Electrical characteristics	4
	2.1 Electrical characteristics (curves)	6
3	Test circuits	8
4	Package information	9
	4.1 I ² PAK package information	9
5	Revision history	11

1 Electrical ratings

Table 2: Absolute maximum ratings

Symbol	Parameter	Value	Unit
V_{DS}	Drain-source voltage	40	V
V_{GS}	Gate-source voltage	± 20	V
$I_D^{(1)}$	Drain current (continuous) at $T_C = 25\text{ }^\circ\text{C}$	120	A
$I_D^{(1)}$	Drain current (continuous) at $T_C = 100\text{ }^\circ\text{C}$	120	A
$I_{DM}^{(2)}$	Drain current (pulsed)	480	A
P_{TOT}	Total dissipation at $T_C = 25\text{ }^\circ\text{C}$	330	W
$dv/dt^{(3)}$	Peak diode recovery voltage slope	3.5	V/ns
$E_{AS}^{(4)}$	Single pulse avalanche energy	1	J
T_j	Operating junction temperature range	-55 to 175	$^\circ\text{C}$
T_{stg}	Storage temperature range		

Notes:

- (1) Current limited by package.
- (2) Pulse width limited by safe operating area.
- (3) $I_{SD} \leq 120\text{ A}$, $di/dt \leq 200\text{ A}/\mu\text{s}$, $V_{DD} \leq V_{(BR)DSS}$, $T_j \leq T_{JMAX}$
- (4) Starting $T_j = 25\text{ }^\circ\text{C}$, $I_D = 80\text{ A}$, $V_{DD} = 32\text{ V}$.

Table 3: Thermal resistance

Symbol	Parameter	Value	Unit
$R_{thj-case}$	Thermal resistance junction-case max	0.45	$^\circ\text{C}/\text{W}$
$R_{thj-amb}$	Thermal resistance junction-ambient	62.5	$^\circ\text{C}/\text{W}$

2 Electrical characteristics

($T_C = 25\text{ °C}$ unless otherwise specified)

Table 4: On/Off states

Symbol	Parameter	Test conditions	Min.	Typ.	Max.	Unit
$V_{(BR)DSS}$	Drain-source breakdown voltage	$V_{GS} = 0\text{ V}$, $I_D = 250\text{ }\mu\text{A}$	40			V
I_{DSS}	Zero gate voltage drain current	$V_{GS} = 0\text{ V}$, $V_{DS} = 40\text{ V}$,			10	μA
		$V_{DS} = 40\text{ V}$, $T_j = 125\text{ °C}$ ⁽¹⁾			100	μA
I_{GSS}	Gate-body leakage current	$V_{DS} = 0\text{ V}$, $V_{GS} = \pm 20\text{ V}$			± 200	nA
$V_{GS(th)}$	Gate threshold voltage	$V_{DS} = V_{GS}$, $I_D = 250\text{ }\mu\text{A}$	2		4	V
$R_{DS(on)}$	Static drain-source on-resistance	$V_{GS} = 10\text{ V}$, $I_D = 80\text{ A}$		2.1	2.6	m Ω

Notes:

⁽¹⁾Defined by design, not subject to production test.

Table 5: Dynamic

Symbol	Parameter	Test conditions	Min.	Typ.	Max.	Unit
g_{fs} ⁽¹⁾	Forward transconductance	$V_{DS} = 15\text{ V}$, $I_D = 80\text{ A}$	-	200	-	S
C_{iss}	Input capacitance	$V_{DS} = 25\text{ V}$, $f = 1\text{ MHz}$, $V_{GS} = 0\text{ V}$	-	7400	-	pF
C_{oss}	Output capacitance		-	1800	-	
C_{rss}	Reverse transfer capacitance		-	47	-	
Q_g	Total gate charge	$V_{DD} = 20\text{ V}$, $I_D = 160\text{ A}$, $V_{GS} = 0\text{ to }10\text{ V}$ (see Figure 14: "Test circuit for gate charge behavior")	-	110	150	nC
Q_{gs}	Gate-source charge		-	27	-	
Q_{gd}	Gate-drain charge		-	25	-	

Notes:

⁽¹⁾Pulsed: pulse duration=300 μs , duty cycle 1.5%.

Table 6: Switching times

Symbol	Parameter	Test conditions	Min.	Typ.	Max.	Unit
$t_{d(on)}$	Turn-on delay time	$V_{DD} = 20\text{ V}$, $I_D = 80\text{ A}$, $R_G = 4.7\text{ }\Omega$, $V_{GS} = 10\text{ V}$ (see Figure 13: "Test circuit for resistive load switching times" and Figure 18: "Switching time waveform")	-	22	-	ns
t_r	Rise time		-	180	-	
$t_{d(off)}$	Turn-off delay time		-	110	-	
t_f	Fall time		-	45	-	

Table 7: Source-drain diode

Symbol	Parameter	Test conditions	Min.	Typ.	Max.	Unit
I_{SD}	Source-drain current		-		120	A
$I_{SDM}^{(1)}$	Source-drain current (pulsed)		-		480	A
$V_{SD}^{(2)}$	Forward on voltage	$I_{DS} = 80 \text{ A}$, $V_{GS} = 0 \text{ V}$	-		1.5	V
t_{rr}	Reverse recovery time	$I_{SD} = 160 \text{ A}$, $di/dt = 100 \text{ A}/\mu\text{s}$ $V_{DD} = 32 \text{ V}$, $T_j = 150 \text{ }^\circ\text{C}$ (see Figure 15: "Test circuit for inductive load switching and diode recovery times")	-	70		ns
Q_{rr}	Reverse recovery charge		-	225		nC
I_{RRM}	Reverse recovery current		-	3.2		A

Notes:

⁽¹⁾Pulse width limited by safe operating area

⁽²⁾Pulsed: pulse duration = 300 μs , duty cycle 1.5 %

2.1 Electrical characteristics (curves)

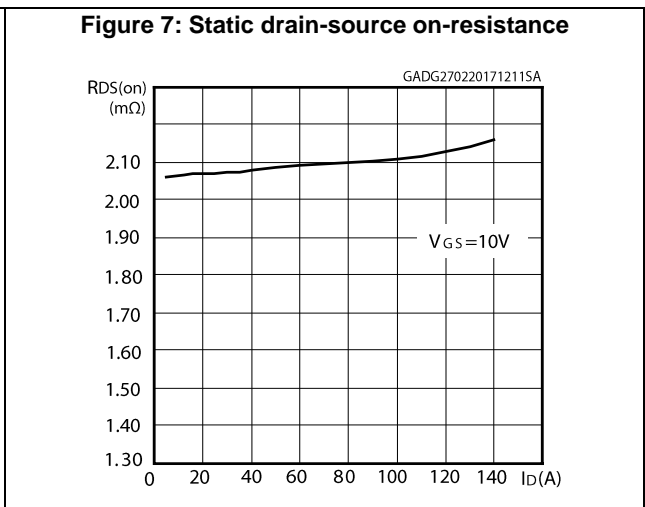
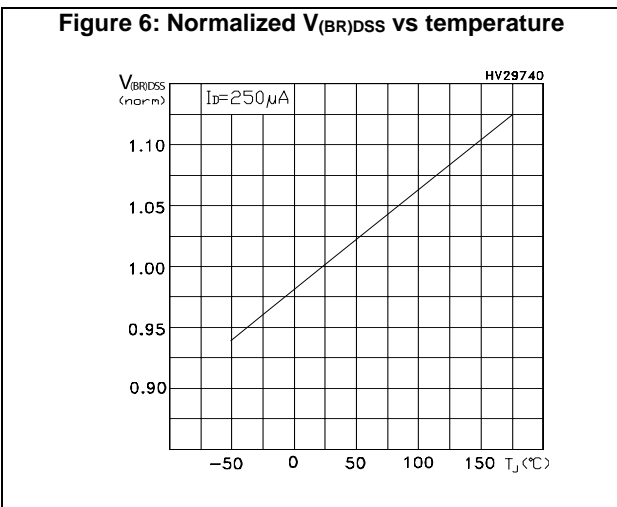
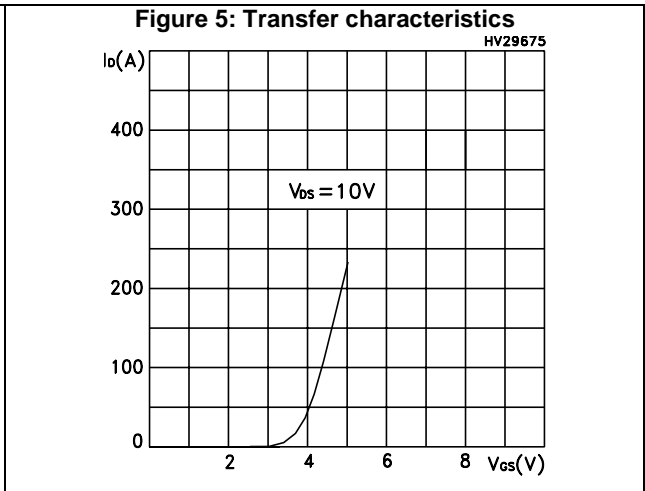
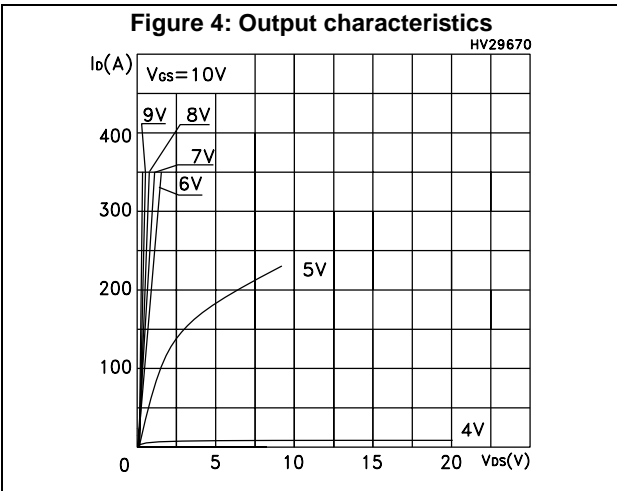
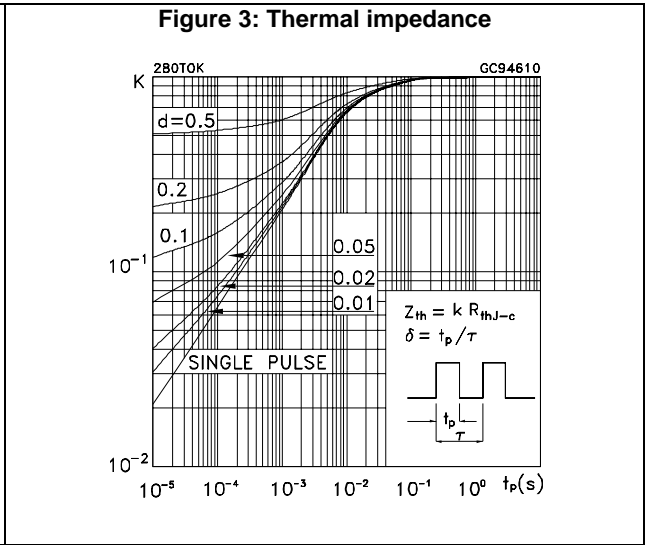
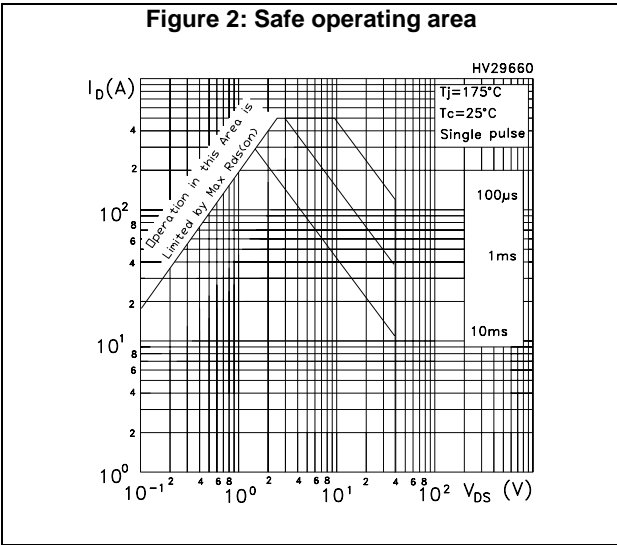

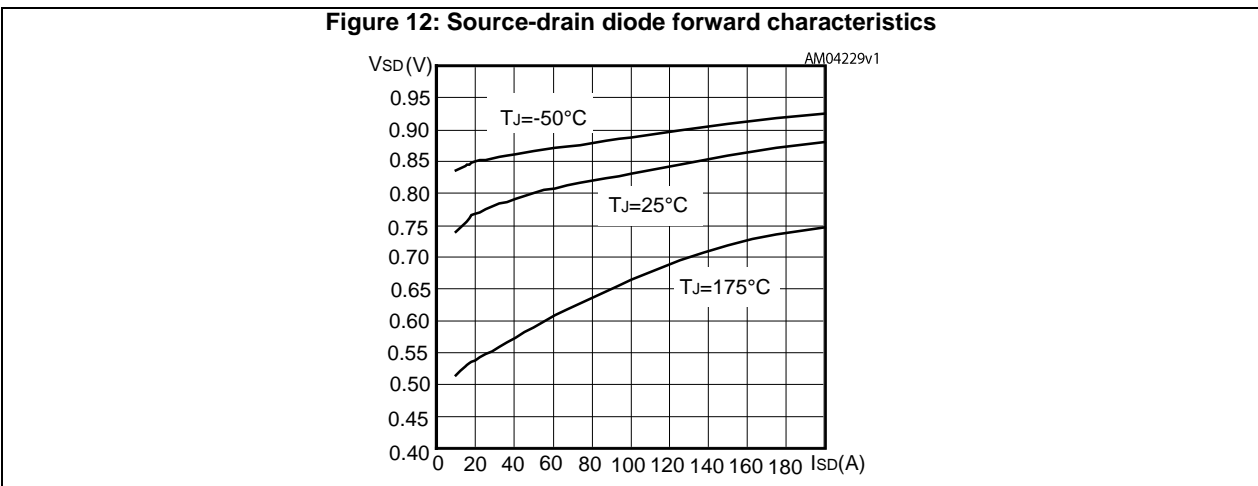
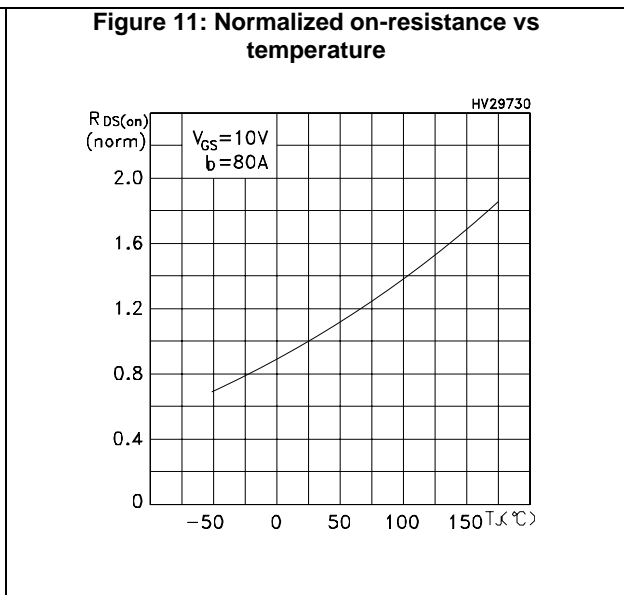
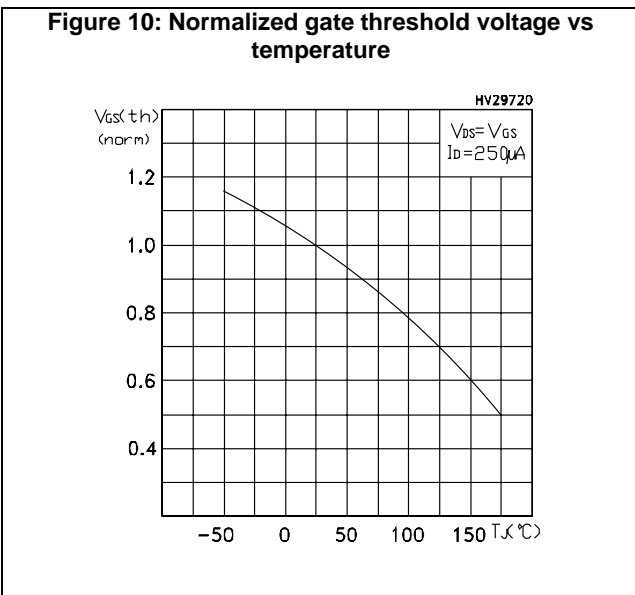
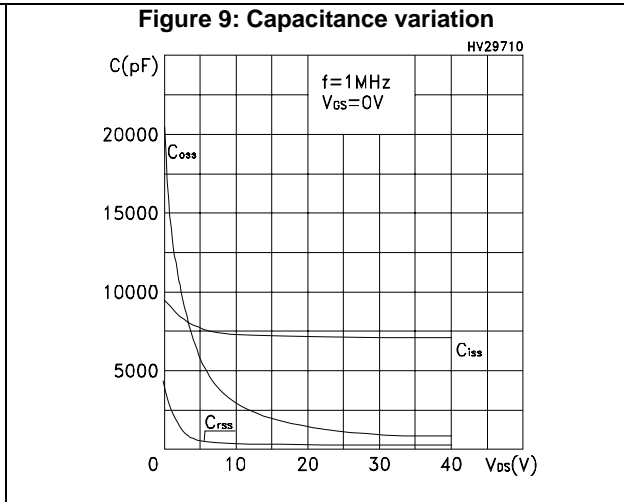
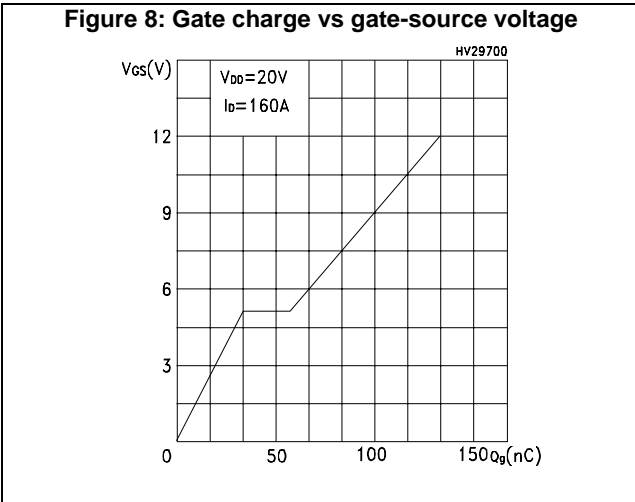

3 Test circuits

Figure 13: Test circuit for resistive load switching times



AM01468v1

Figure 14: Test circuit for gate charge behavior



AM01469v1

Figure 15: Test circuit for inductive load switching and diode recovery times



AM01470v1

Figure 16: Unclamped inductive load test circuit



AM01471v1

Figure 17: Unclamped inductive waveform

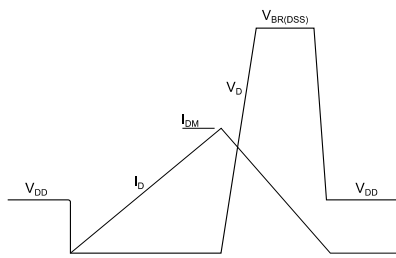

AM01472v1

Figure 18: Switching time waveform

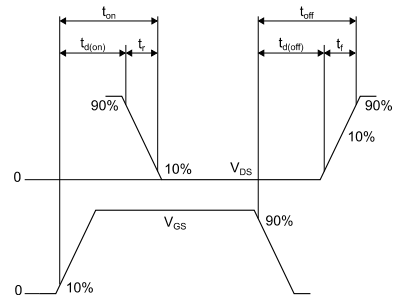

AM01473v1

4 Package information

In order to meet environmental requirements, ST offers these devices in different grades of ECOPACK® packages, depending on their level of environmental compliance. ECOPACK® specifications, grade definitions and product status are available at: www.st.com. ECOPACK® is an ST trademark.

4.1 I²PAK package information

Figure 19: I²PAK package outline

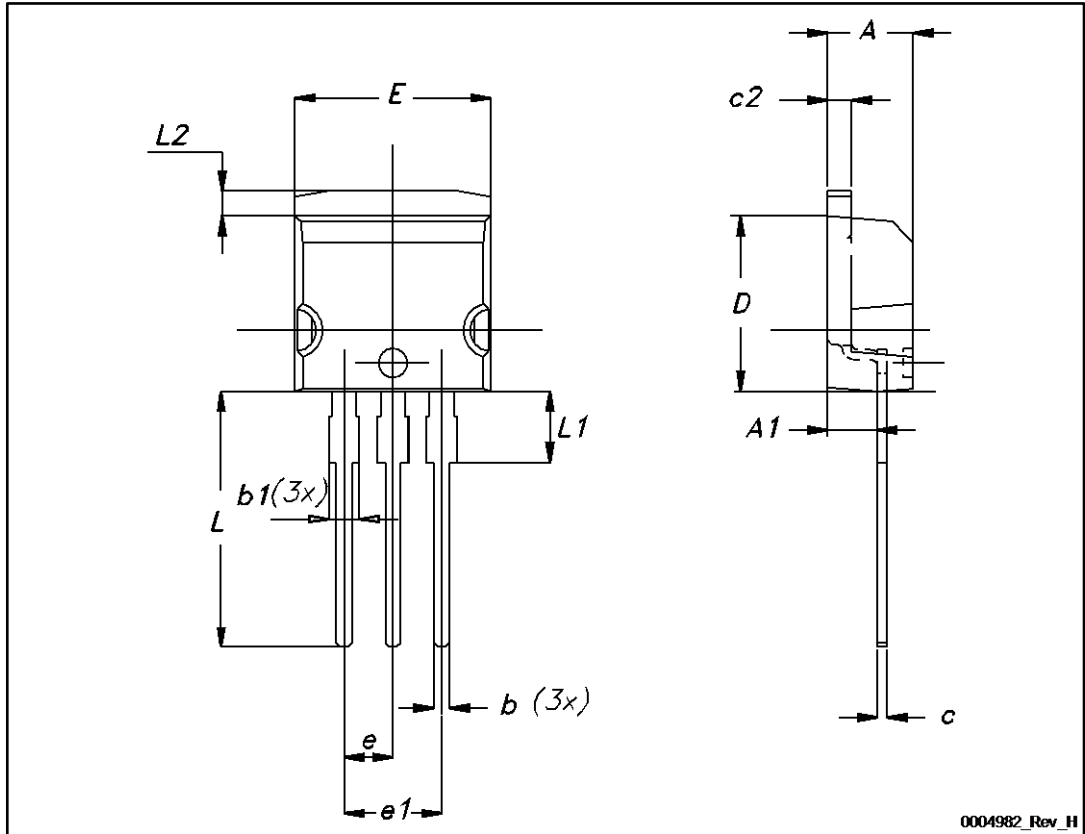

Table 8: I²PAK package mechanical data

Dim.	mm		
	Min.	Typ.	Max.
A	4.40	-	4.60
A1	2.40	-	2.72
b	0.61	-	0.88
b1	1.14	-	1.70
c	0.49	-	0.70
c2	1.23	-	1.32
D	8.95	-	9.35
e	2.40	-	2.70
e1	4.95	-	5.15
E	10	-	10.40
L	13	-	14
L1	3.50	-	3.93
L2	1.27	-	1.40

5 Revision history

Table 9: Document revision history

Date	Revision	Changes
01-Mar-2017	1	First release.

IMPORTANT NOTICE – PLEASE READ CAREFULLY

STMicroelectronics NV and its subsidiaries ("ST") reserve the right to make changes, corrections, enhancements, modifications, and improvements to ST products and/or to this document at any time without notice. Purchasers should obtain the latest relevant information on ST products before placing orders. ST products are sold pursuant to ST's terms and conditions of sale in place at the time of order acknowledgement.

Purchasers are solely responsible for the choice, selection, and use of ST products and ST assumes no liability for application assistance or the design of Purchasers' products.

No license, express or implied, to any intellectual property right is granted by ST herein.

Resale of ST products with provisions different from the information set forth herein shall void any warranty granted by ST for such product.

ST and the ST logo are trademarks of ST. All other product or service names are the property of their respective owners.

Information in this document supersedes and replaces information previously supplied in any prior versions of this document.

© 2017 STMicroelectronics – All rights reserved