

## P-channel -100 V, 0.136 $\Omega$ typ., -3 A STripFET™ F6 Power MOSFET in an SOT-223 package

Datasheet - preliminary data

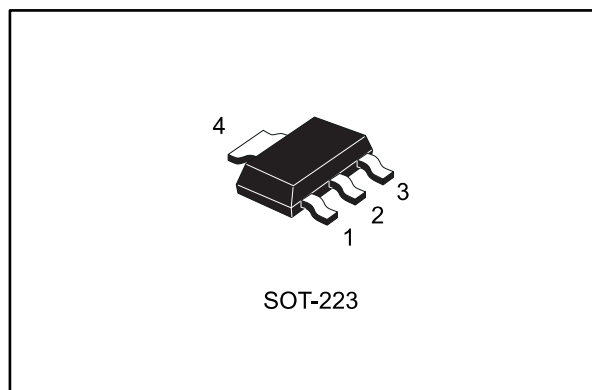
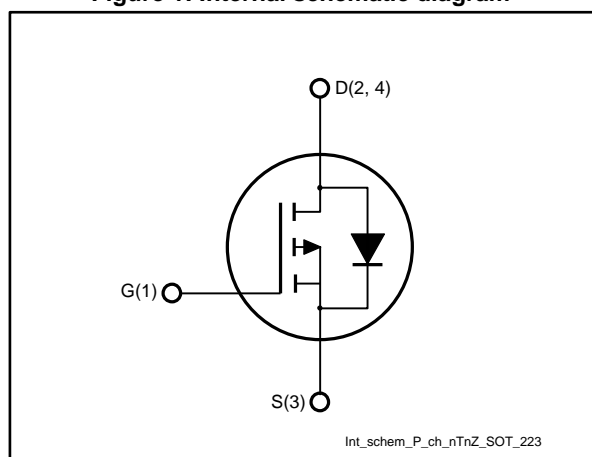

Figure 1: Internal schematic diagram



### Features

Order code	V <sub>DS</sub>	R <sub>DS(on)</sub> max.	I <sub>D</sub>
STN3P10F6	-100 V	0.180 $\Omega$	-3 A

- Very low on-resistance
- Very low gate charge
- High avalanche ruggedness
- Low gate drive power loss

### Applications

- Switching applications

### Description

This device is a P-channel Power MOSFET developed using the STripFET™ F6 technology, with a new trench gate structure. The resulting Power MOSFET exhibits very low R<sub>DS(on)</sub> in all packages.

Table 1: Device summary

Order code	Marking	Package	Packing
STN3P10F6	3P10F6	SOT-223	Tape and reel

---

## Contents

<b>1</b>	<b>Electrical ratings .....</b>	<b>3</b>
<b>2</b>	<b>Electrical characteristics .....</b>	<b>4</b>
	2.1 Electrical characteristics (curves).....	6
<b>3</b>	<b>Test circuits .....</b>	<b>9</b>
<b>4</b>	<b>Package information .....</b>	<b>10</b>
	4.1 SOT-223 package information .....	10
<b>5</b>	<b>Revision history .....</b>	<b>12</b>

# 1 Electrical ratings

**Table 2: Absolute maximum ratings**

Symbol	Parameter	Value	Unit
$V_{DS}$	Drain-source voltage	-100	V
$V_{GS}$	Gate-source voltage	$\pm 20$	V
$I_D$	Drain current (continuous) at $T_{pcb} = 25\text{ }^\circ\text{C}$	-3	A
	Drain current (continuous) at $T_{pcb} = 100\text{ }^\circ\text{C}$	-2	A
$I_{DM}$	Drain current (pulsed)	-12	A
$P_{TOT}^{(1)}$	Total dissipation at $T_{pcb} = 25\text{ }^\circ\text{C}$	3.3	W
$T_j$	Operating junction temperature range	-55 to 175	$^\circ\text{C}$
$T_{stg}$	Storage temperature range		$^\circ\text{C}$

**Notes:**

<sup>(1)</sup>Pulse width is limited by safe operating area

**Table 3: Thermal data**

Symbol	Parameter	Value	Unit
$R_{thj-pcb}^{(1)}$	Thermal resistance junction-pcb	46	$^\circ\text{C}/\text{W}$

**Notes:**

<sup>(1)</sup>When mounted on FR-4 board of 1 inch<sup>2</sup>, 2 Oz Cu,  $t < 10\text{ s}$

## 2 Electrical characteristics

( $T_C = 25\text{ °C}$  unless otherwise specified)

**Table 4: On/off states**

Symbol	Parameter	Test conditions	Min.	Typ.	Max.	Unit
$V_{(BR)DSS}$	Drain-source breakdown voltage	$V_{GS} = 0\text{ V}$ , $I_D = -1\text{ mA}$	-100			V
$I_{DSS}$	Zero gate voltage drain current	$V_{GS} = 0\text{ V}$ , $V_{DS} = -100\text{ V}$			-1	$\mu\text{A}$
		$V_{GS} = 0\text{ V}$ , $V_{DS} = -100\text{ V}$ , $T_C = 125\text{ °C}^{(1)}$			-10	$\mu\text{A}$
$I_{GSS}$	Gate-body leakage current	$V_{DS} = 0\text{ V}$ , $V_{GS} = \pm 20\text{ V}$			$\pm 100$	nA
$V_{GS(th)}$	Gate threshold voltage	$V_{DS} = V_{GS}$ , $I_D = -250\text{ }\mu\text{A}$	-2		-4	V
$R_{DS(on)}$	Static drain-source on-resistance	$V_{GS} = -10\text{ V}$ , $I_D = -1.5\text{ A}$		0.136	0.180	$\Omega$

**Notes:**

<sup>(1)</sup>Defined by design, not subject to production test.

**Table 5: Dynamic**

Symbol	Parameter	Test conditions	Min.	Typ.	Max.	Unit
$C_{iss}$	Input capacitance	$V_{DS} = -25\text{ V}$ , $f = 1\text{ MHz}$ , $V_{GS} = 0\text{ V}$	-	900	-	pF
$C_{oss}$	Output capacitance		-	60	-	pF
$C_{rss}$	Reverse transfer capacitance		-	33	-	pF
$Q_g$	Total gate charge	$V_{DD} = -50\text{ V}$ , $I_D = -3\text{ A}$ , $V_{GS} = -10\text{ V}$ (see <a href="#">Figure 14: "Gate charge test circuit"</a> )	-	16.5	-	nC
$Q_{gs}$	Gate-source charge		-	3.5	-	nC
$Q_{gd}$	Gate-drain charge		-	3.8	-	nC

**Table 6: Switching times**

Symbol	Parameter	Test conditions	Min.	Typ.	Max.	Unit
$t_{d(on)}$	Turn-on delay time	$V_{DD} = -50\text{ V}$ , $I_D = -1.5\text{ A}$ , $R_G = 4.7\text{ }\Omega$ , $V_{GS} = -10\text{ V}$ (see <a href="#">Figure 13: "Switching times test circuit for resistive load"</a> )	-	10.5	-	ns
$t_r$	Rise time		-	4.8	-	ns
$t_{d(off)}$	Turn-off delay time		-	24	-	ns
$t_f$	Fall time		-	4.5	-	ns

Table 7: Source drain diode

Symbol	Parameter	Test conditions	Min.	Typ.	Max.	Unit
$V_{SD}^{(1)}$	Forward on voltage	$I_{SD} = -3 \text{ A}$ , $V_{GS} = 0 \text{ V}$	-		-1.1	V
$t_{rr}$	Reverse recovery time	$I_{SD} = -3 \text{ A}$ , $di/dt = 100 \text{ A}/\mu\text{s}$ , $V_{DD} = -80 \text{ V}$ , $T_j = 150 \text{ }^\circ\text{C}$ (see <a href="#">Figure 15: "Test circuit for inductive load switching and diode recovery times"</a> )	-	26.5		ns
$Q_{rr}$	Reverse recovery charge		-	36.5		nC
$I_{RRM}$	Reverse recovery current		-	-2.7		A

**Notes:**

<sup>(1)</sup>Pulse duration = 300  $\mu\text{s}$ , duty cycle 1.5%

## 2.1 Electrical characteristics (curves)



For the P-channel Power MOSFET, current and voltage polarities are reversed.

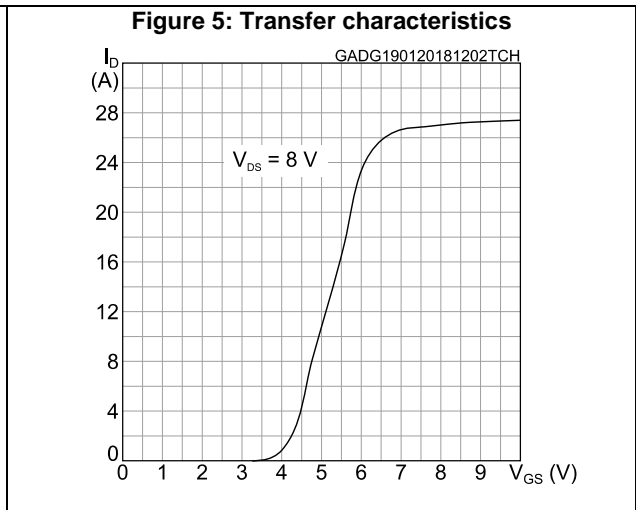
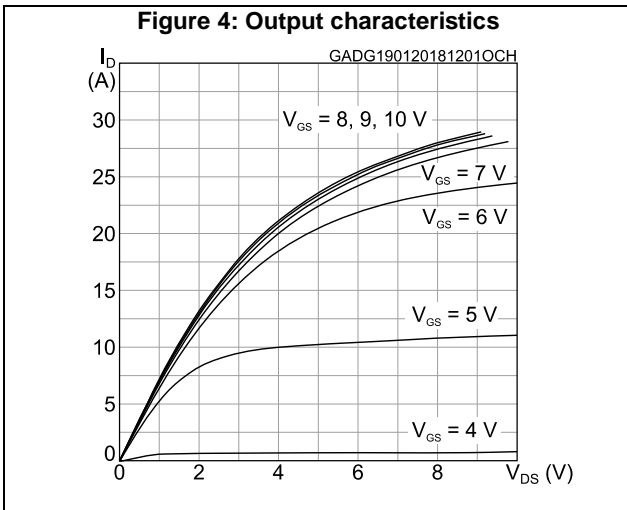
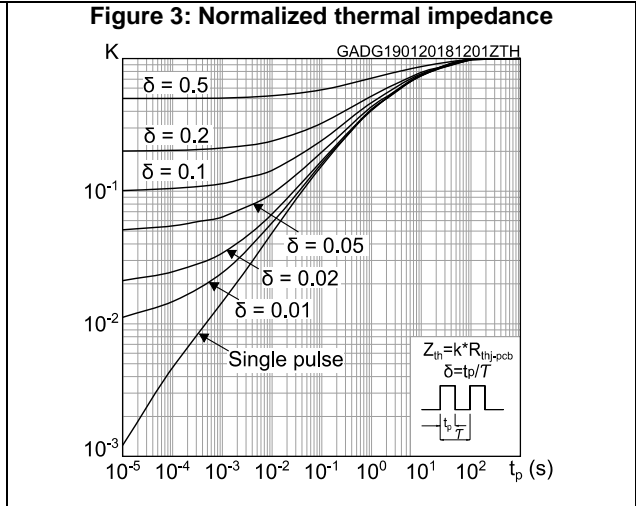
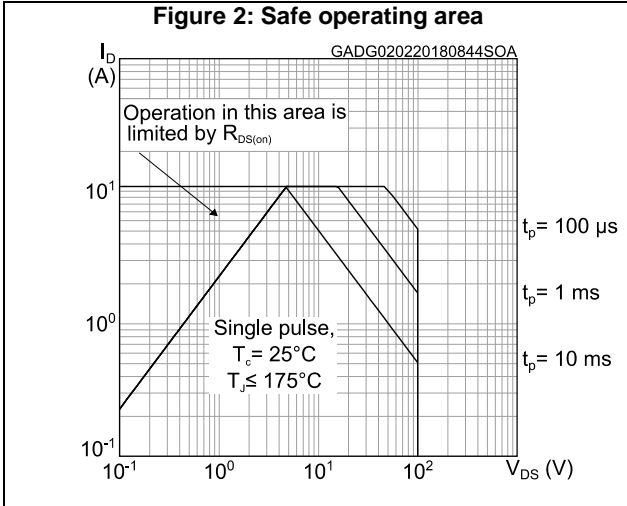

Figure 6: Gate charge vs gate-source voltage

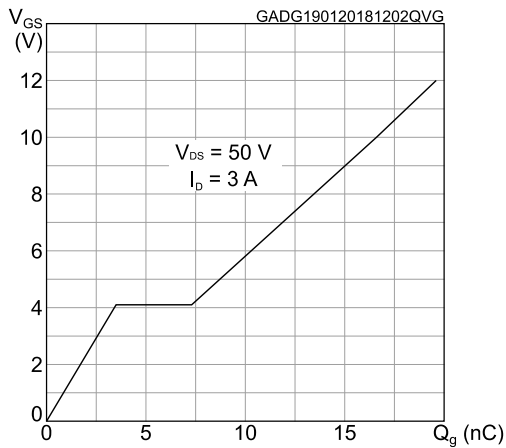

Figure 7: Capacitance variations

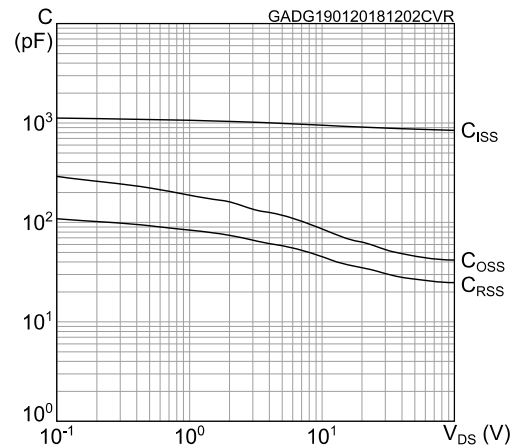

Figure 8: Static drain-source on-resistance

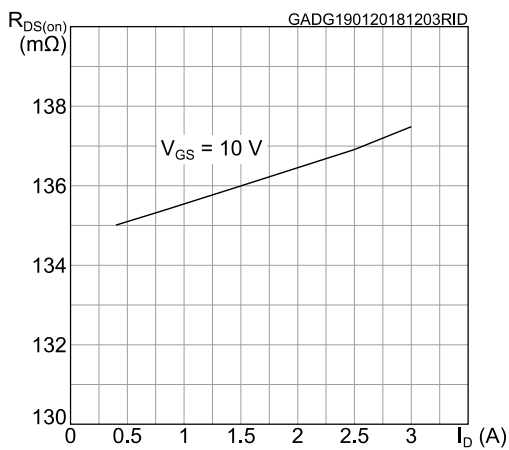

Figure 9: Normalized gate threshold voltage vs temperature

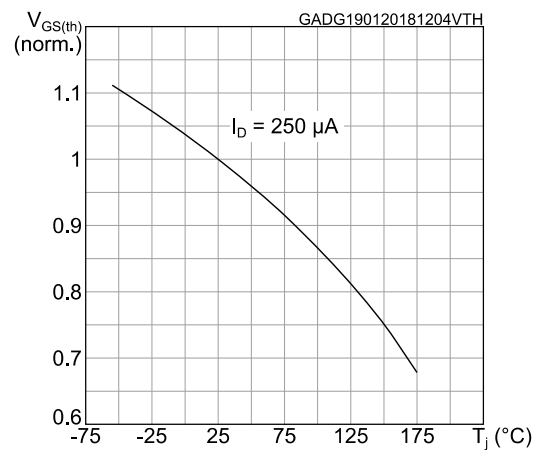

Figure 10: Normalized on-resistance vs temperature

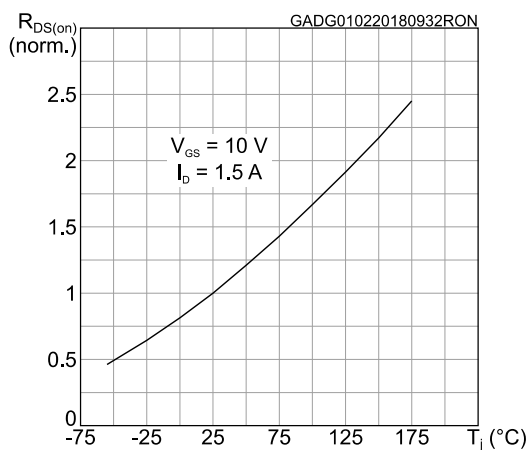

Figure 11: Normalized  $V_{(BR)DSS}$  vs temperature

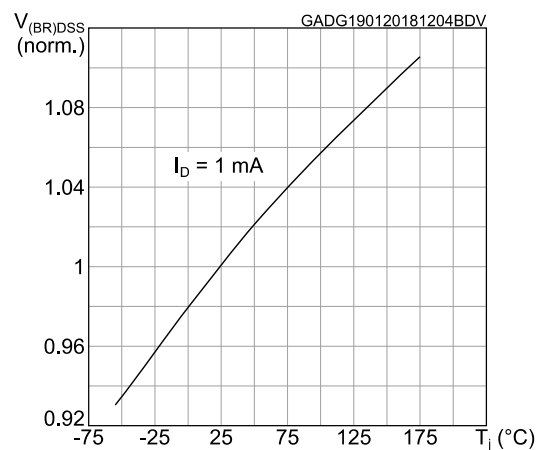
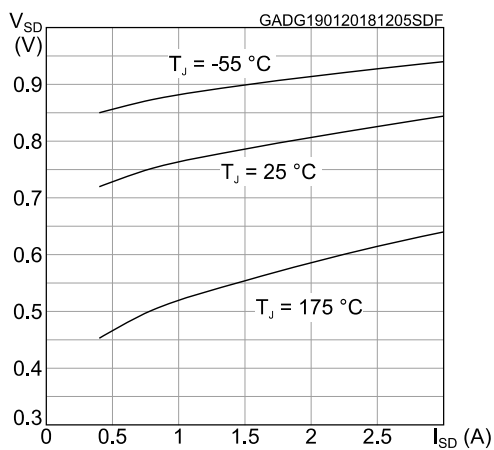

Figure 12: Source-drain diode forward characteristics





### 3 Test circuits

Figure 13: Switching times test circuit for resistive load

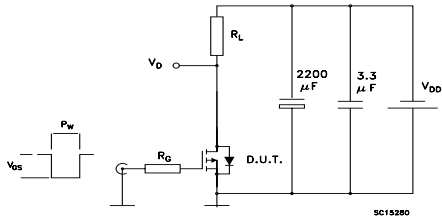

Figure 14: Gate charge test circuit

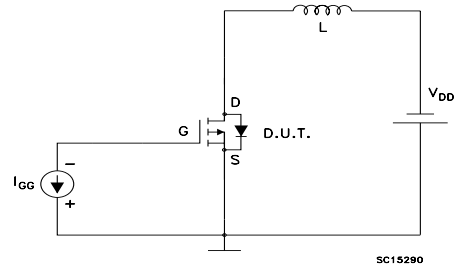
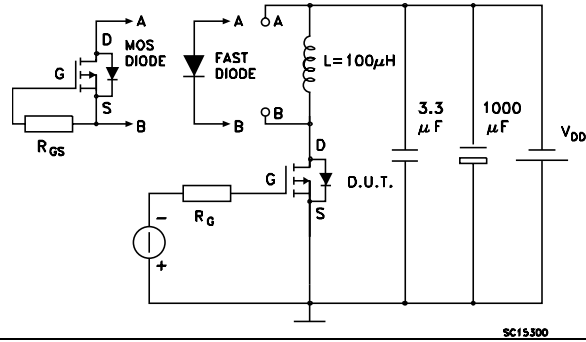

Figure 15: Test circuit for inductive load switching and diode recovery times



## 4 Package information

In order to meet environmental requirements, ST offers these devices in different grades of ECOPACK® packages, depending on their level of environmental compliance. ECOPACK® specifications, grade definitions and product status are available at: [www.st.com](http://www.st.com). ECOPACK® is an ST trademark.

### 4.1 SOT-223 package information

Figure 16: SOT-223 package outline

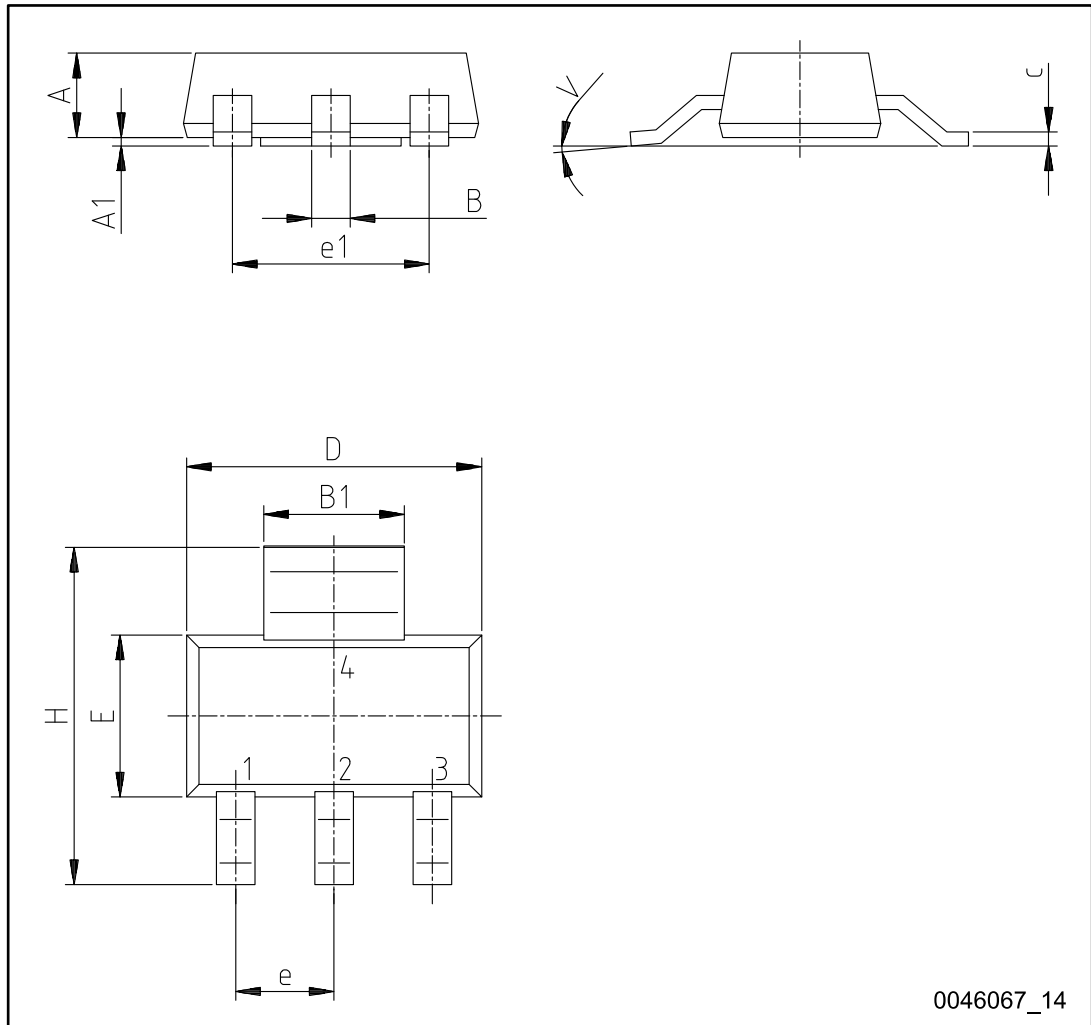

0046067\_14

Table 8: SOT-223 package mechanical data

Dim.	mm		
	Min.	Typ.	Max.
A			1.8
A1	0.02		0.1
B	0.6	0.7	0.85
B1	2.9	3	3.15
c	0.24	0.26	0.35
D	6.3	6.5	6.7
e		2.3	
e1		4.6	
E	3.3	3.5	3.7
H	6.7	7.0	7.3
V			10°

Figure 17: SOT-223 recommended footprint (dimensions are in mm)

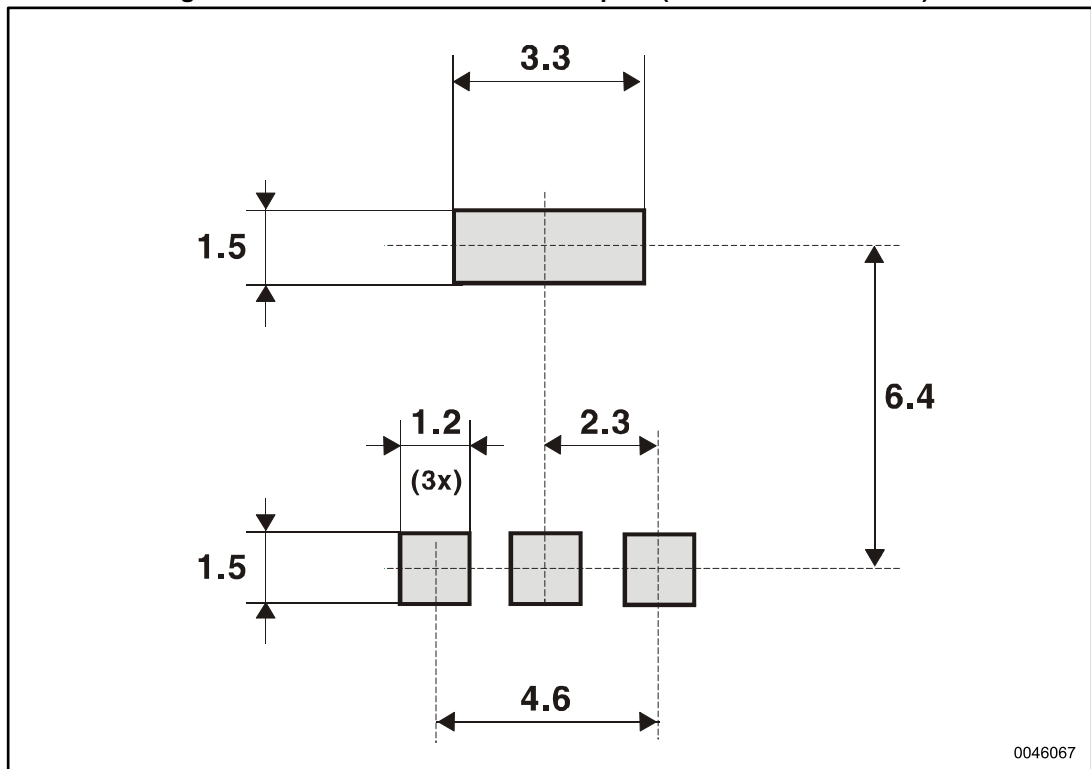

## 5 Revision history

**Table 9: Document revision history**

Date	Revision	Changes
02-Aug-2017	1	First release.
07-Feb-2018	2	Updated <i>Section 1: "Electrical ratings"</i> . Added <i>Section 2.1: "Electrical characteristics (curves)"</i> . Minor text changes

**IMPORTANT NOTICE – PLEASE READ CAREFULLY**

STMicroelectronics NV and its subsidiaries ("ST") reserve the right to make changes, corrections, enhancements, modifications, and improvements to ST products and/or to this document at any time without notice. Purchasers should obtain the latest relevant information on ST products before placing orders. ST products are sold pursuant to ST's terms and conditions of sale in place at the time of order acknowledgement.

Purchasers are solely responsible for the choice, selection, and use of ST products and ST assumes no liability for application assistance or the design of Purchasers' products.

No license, express or implied, to any intellectual property right is granted by ST herein.

Resale of ST products with provisions different from the information set forth herein shall void any warranty granted by ST for such product.

ST and the ST logo are trademarks of ST. All other product or service names are the property of their respective owners.

Information in this document supersedes and replaces information previously supplied in any prior versions of this document.

© 2018 STMicroelectronics – All rights reserved