

N-channel 600 V, 0.260 Ω typ., 12 A MDmesh DM2 Power MOSFET in a TO-220 package

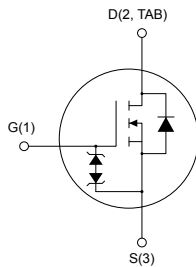

AM01475V1

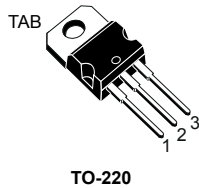

Product status links

[STP18N60DM2](#)

Product summary

Order code	STP18N60DM2
Marking	18N60DM2
Package	TO-220
Packing	Tube

Features

Order code	V_{DS}	$R_{DS(on)}$ max.	I_D
STP18N60DM2	600 V	0.295 Ω	12 A

- Fast-recovery body diode
- Extremely low gate charge and input capacitance
- Low on-resistance
- 100% avalanche tested
- Extremely high dv/dt ruggedness
- Zener-protected

Applications

- Switching applications

Description

This high-voltage N-channel Power MOSFET is part of the MDmesh DM2 fast-recovery diode series. It offers very low recovery charge (Q_{rr}) and time (t_{rr}) combined with low $R_{DS(on)}$, rendering it suitable for the most demanding high-efficiency converters and ideal for bridge topologies and ZVS phase-shift converters.

1 Electrical ratings

Table 1. Absolute maximum ratings

Symbol	Parameter	Value	Unit
V_{GS}	Gate-source voltage	±25	V
I_D	Drain current (continuous) at $T_{case} = 25\text{ °C}$	12	A
I_D	Drain current (continuous) at $T_{case} = 100\text{ °C}$	7.6	A
$I_{DM}^{(1)}$	Drain current (pulsed)	48	A
P_{TOT}	Total power dissipation at $T_{case} = 25\text{ °C}$	110	W
$dv/dt^{(2)}$	Peak diode recovery voltage slope	40	V/ns
$dv/dt^{(3)}$	MOSFET dv/dt ruggedness	50	
T_{stg}	Storage temperature range	-55 to 150	°C
T_j	Operating junction temperature range		°C

1. Pulse width is limited by safe operating area.
2. $I_{SD} \leq 12$, $di/dt \leq 400\text{ A}/\mu\text{s}$, $V_{DS(peak)} < V_{(BR)DSS}$, $V_{DD} = 400\text{ V}$
3. $V_{DS} \leq 480\text{ V}$

Table 2. Thermal data

Symbol	Parameter	Value	Unit
$R_{thj-case}$	Thermal resistance junction-case	1.14	°C/W
$R_{thj-amb}$	Thermal resistance junction-ambient	62.5	

Table 3. Avalanche characteristics

Symbol	Parameter	Value	Unit
I_{AR}	Avalanche current, repetitive or not repetitive (pulse width limited by T_{jmax})	2.5	A
E_{AR}	Single pulse avalanche energy (starting $T_j = 25\text{ °C}$, $I_D = I_{AR}$, $V_{DD} = 50\text{ V}$)	380	mJ

2 Electrical characteristics

($T_{case} = 25\text{ °C}$ unless otherwise specified)

Table 4. Static

Symbol	Parameter	Test conditions	Min.	Typ.	Max.	Unit
$V_{(BR)DSS}$	Drain-source breakdown voltage	$V_{GS} = 0\text{ V}$, $I_D = 1\text{ mA}$	600			V
I_{DSS}	Zero gate voltage drain current	$V_{GS} = 0\text{ V}$, $V_{DS} = 600\text{ V}$			1	μA
		$V_{GS} = 0\text{ V}$, $V_{DS} = 600\text{ V}$, $T_{case} = 125\text{ °C}$ ⁽¹⁾			100	μA
I_{GSS}	Gate-body leakage current	$V_{DS} = 0\text{ V}$, $V_{GS} = \pm 25\text{ V}$			± 5	μA
$V_{GS(th)}$	Gate threshold voltage	$V_{DS} = V_{GS}$, $I_D = 250\text{ }\mu\text{A}$	3	4	5	V
$R_{DS(on)}$	Static drain-source on-resistance	$V_{GS} = 10\text{ V}$, $I_D = 6\text{ A}$		0.260	0.295	Ω

1. Defined by design, not subject to production test.

Table 5. Dynamic

Symbol	Parameter	Test conditions	Min.	Typ.	Max.	Unit
C_{iss}	Input capacitance	$V_{DS} = 100\text{ V}$, $f = 1\text{ MHz}$, $V_{GS} = 0\text{ V}$	-	800	-	pF
C_{oss}	Output capacitance		-	40	-	pF
C_{rSS}	Reverse transfer capacitance		-	1.33	-	pF
$C_{oss\ eq.}^{(1)}$	Equivalent output capacitance	$V_{DS} = 0$ to 480 V , $f = 1\text{ MHz}$, $V_{GS} = 0\text{ V}$	-	80	-	pF
R_G	Intrinsic gate resistance	$f = 1\text{ MHz}$, $I_D = 0\text{ A}$	-	5.6	-	Ω
Q_g	Total gate charge	$V_{DD} = 480\text{ V}$, $I_D = 12\text{ A}$, $V_{GS} = 0$ to 10 V (see Figure 14. Test circuit for gate charge behavior)	-	20	-	nC
Q_{gs}	Gate-source charge		-	5.2	-	nC
Q_{gd}	Gate-drain charge		-	8.5	-	nC

1. $C_{oss\ eq.}$ is defined as a constant equivalent capacitance giving the same charging time as C_{oss} when V_{DS} increases from 0 to 80% V_{DSS}

Table 6. Switching times

Symbol	Parameter	Test conditions	Min.	Typ.	Max.	Unit
$t_{d(on)}$	Turn-on delay time	$V_{DD} = 300\text{ V}$, $I_D = 6\text{ A}$, $R_G = 4.7\text{ }\Omega$, $V_{GS} = 10\text{ V}$ (see Figure 13. Test circuit for resistive load switching times and Figure 18. Switching time waveform)	-	13.5	-	ns
t_r	Rise time		-	8	-	ns
$t_{d(off)}$	Turn-off delay time		-	9.5	-	ns
t_f	Fall time		-	32.5	-	ns

Table 7. Source-drain diode

Symbol	Parameter	Test conditions	Min.	Typ.	Max.	Unit
I_{SD}	Source-drain current		-		12	A
$I_{SDM}^{(1)}$	Source-drain current (pulsed)		-		48	A
$V_{SD}^{(2)}$	Forward on voltage	$V_{GS} = 0\text{ V}$, $I_{SD} = 12\text{ A}$	-		1.6	V
t_{rr}	Reverse recovery time	$I_{SD} = 12\text{ A}$, $di/dt = 100\text{ A}/\mu\text{s}$, $V_{DD} = 60\text{ V}$ (see Figure 15. Test circuit for inductive load switching and diode recovery times)	-	125		ns
Q_{rr}	Reverse recovery charge		-	0.675		μC
I_{RRM}	Reverse recovery current		-	11		A
t_{rr}	Reverse recovery time	$I_{SD} = 12\text{ A}$, $di/dt = 100\text{ A}/\mu\text{s}$, $V_{DD} = 60\text{ V}$, $T_j = 150\text{ }^\circ\text{C}$ (see Figure 15. Test circuit for inductive load switching and diode recovery times)	-	190		ns
Q_{rr}	Reverse recovery charge		-	1.225		μC
I_{RRM}	Reverse recovery current		-	13		A

1. Pulse width is limited by safe operating area.
2. Pulse test: pulse duration = 300 μs , duty cycle 1.5%.

2.1 Electrical characteristics (curves)

Figure 1. Safe operating area

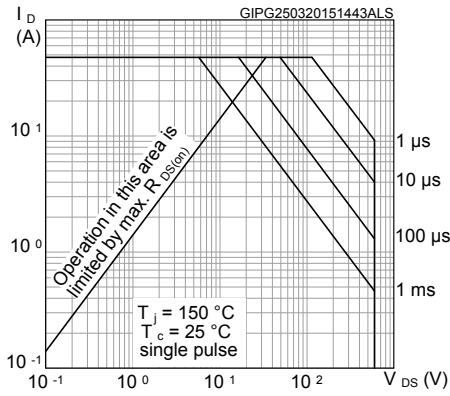

Figure 2. Thermal impedance

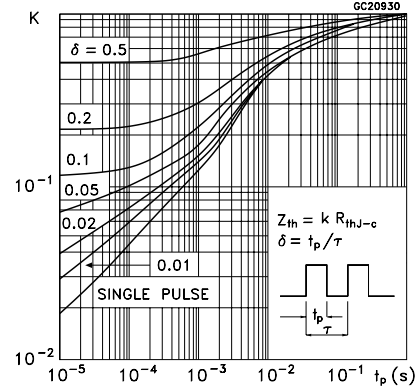

Figure 3. Output characteristics

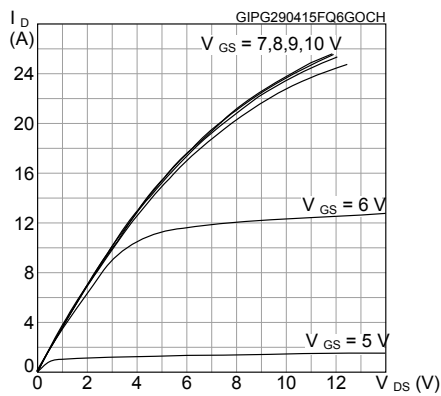

Figure 4. Transfer characteristics

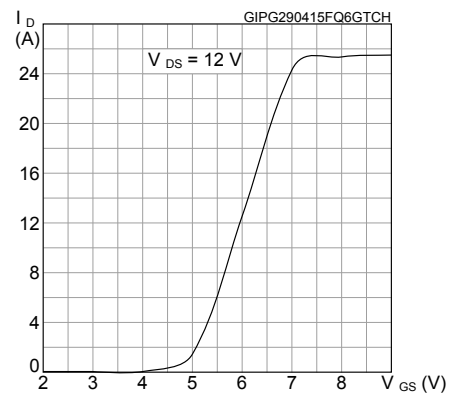

Figure 5. Gate charge vs gate-source voltage

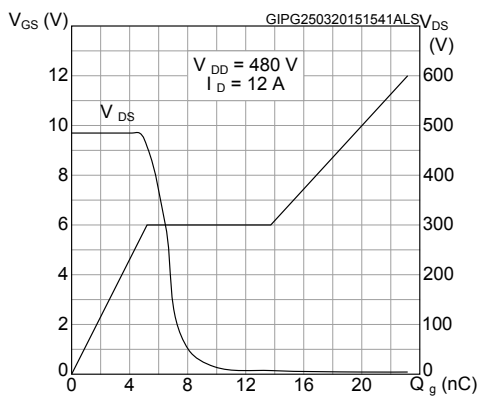

Figure 6. Static drain-source on-resistance

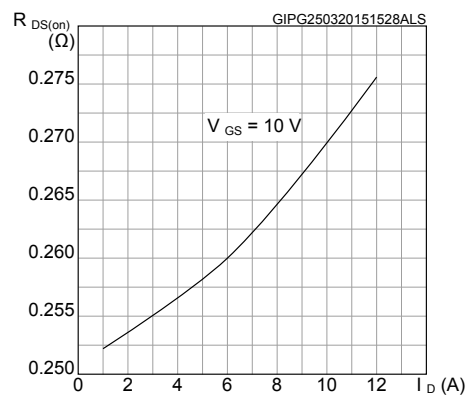

Figure 7. Capacitance variations

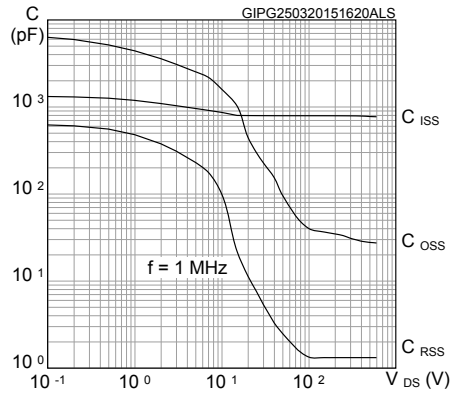

Figure 8. Normalized gate threshold voltage vs temperature

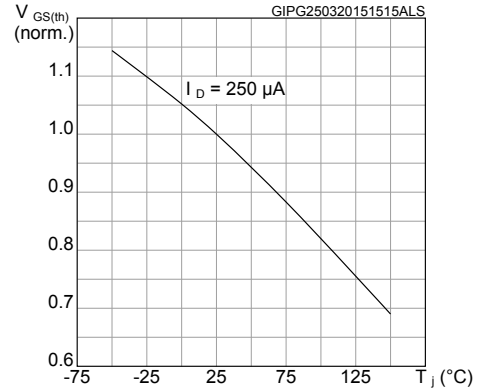

Figure 9. Normalized on-resistance vs temperature

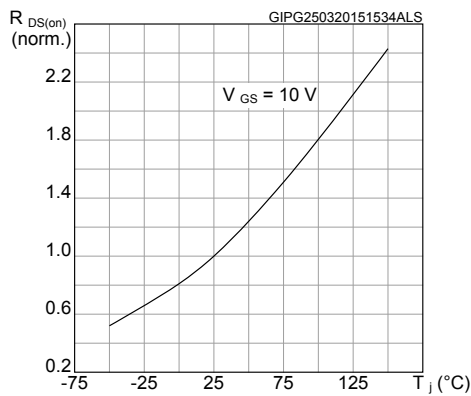

Figure 10. Normalized $V_{(BR)DSS}$ vs temperature

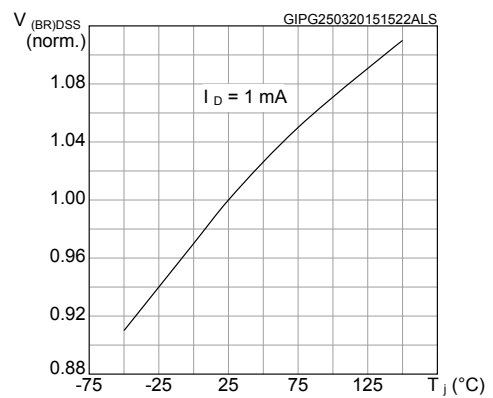

Figure 11. Source-drain diode forward characteristics

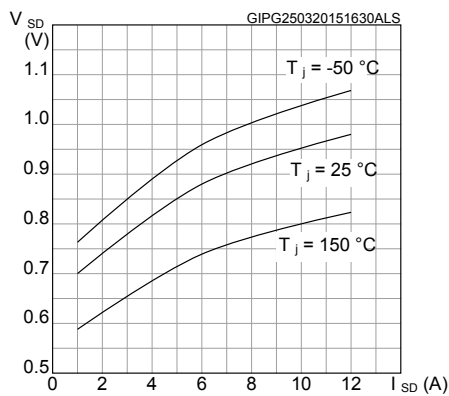
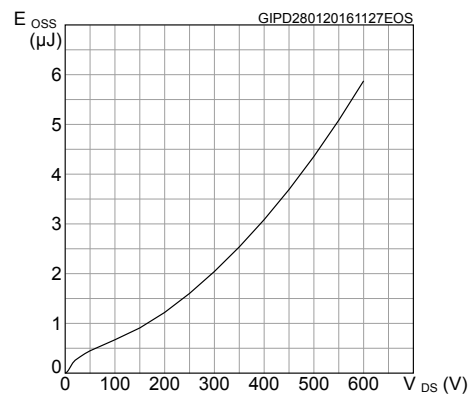
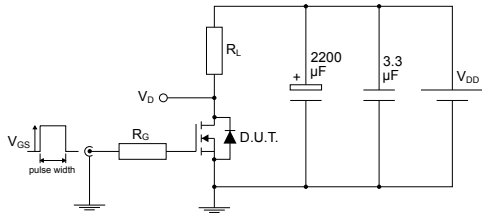

Figure 12. Output capacitance stored energy



3 Test circuits

Figure 13. Test circuit for resistive load switching times



AM01468v1

Figure 14. Test circuit for gate charge behavior

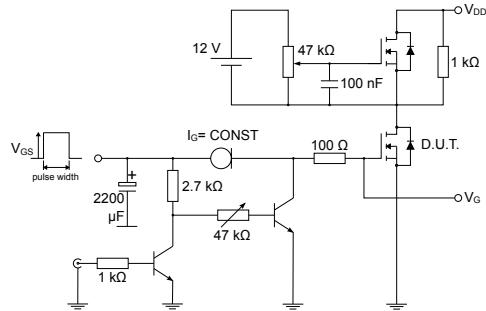

AM01469v1

Figure 15. Test circuit for inductive load switching and diode recovery times

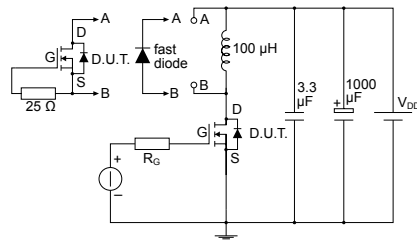

AM01470v1

Figure 16. Unclamped inductive load test circuit

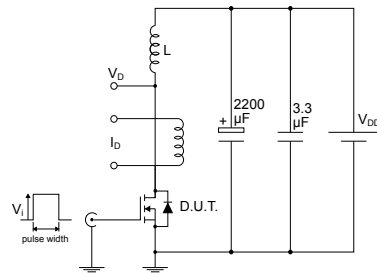

AM01471v1

Figure 17. Unclamped inductive waveform

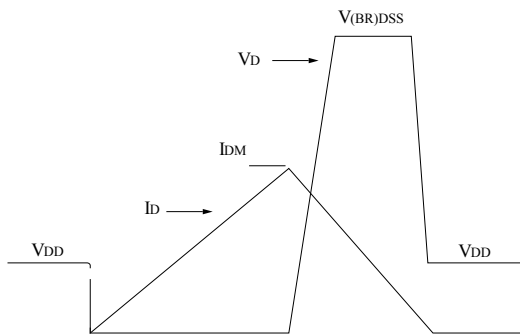

AM01472v1

Figure 18. Switching time waveform

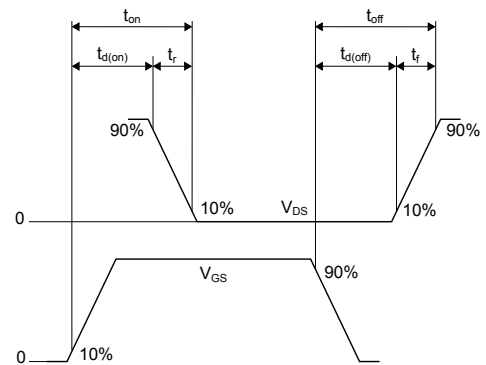

AM01473v1

4 Package information

In order to meet environmental requirements, ST offers these devices in different grades of **ECOPACK** packages, depending on their level of environmental compliance. ECOPACK specifications, grade definitions and product status are available at: www.st.com. ECOPACK is an ST trademark.

4.1 TO-220 type A package information

Figure 19. TO-220 type A package outline

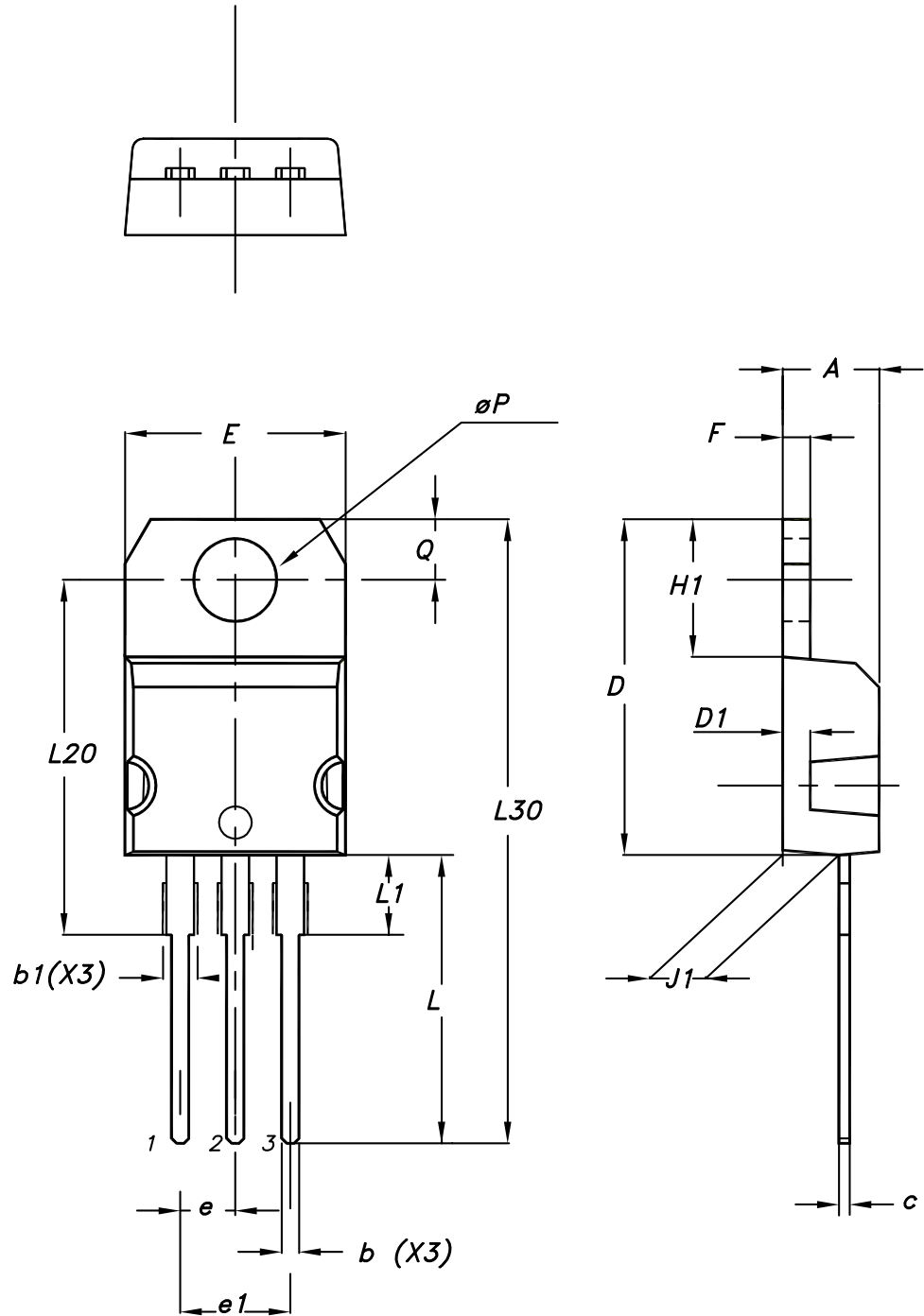

0015988_typeA_Rev_22

Table 8. TO-220 type A package mechanical data

Dim.	mm		
	Min.	Typ.	Max.
A	4.40		4.60
b	0.61		0.88
b1	1.14		1.55
c	0.48		0.70
D	15.25		15.75
D1		1.27	
E	10.00		10.40
e	2.40		2.70
e1	4.95		5.15
F	1.23		1.32
H1	6.20		6.60
J1	2.40		2.72
L	13.00		14.00
L1	3.50		3.93
L20		16.40	
L30		28.90	
øP	3.75		3.85
Q	2.65		2.95

Revision history

Table 9. Document revision history

Date	Revision	Changes
01-Apr-2015	1	First release.
21-May-2015	2	Text edits throughout document In <i>Section 2.1 Electrical characteristics (curves)</i> : - updated <i>Figure 4: Output characteristics</i> - updated <i>Figure 5: Transfer characteristics</i>
28-Jan-2016	3	Updated <i>Section 2.1: "Electrical characteristics (curves)"</i>
13-Sep-2016	4	Updated title in cover page.
10-Jun-2019	5	Modified Table 1, Table 2, Table 4. Static and Table 7. Source-drain diode . Minor text changes.

Contents

1	Electrical ratings	2
2	Electrical characteristics	3
2.1	Electrical characteristics (curves)	5
3	Test circuits	7
4	Package information	8
4.1	TO-220 type A package information	8
	Revision history	11

IMPORTANT NOTICE – PLEASE READ CAREFULLY

STMicroelectronics NV and its subsidiaries (“ST”) reserve the right to make changes, corrections, enhancements, modifications, and improvements to ST products and/or to this document at any time without notice. Purchasers should obtain the latest relevant information on ST products before placing orders. ST products are sold pursuant to ST’s terms and conditions of sale in place at the time of order acknowledgement.

Purchasers are solely responsible for the choice, selection, and use of ST products and ST assumes no liability for application assistance or the design of Purchasers’ products.

No license, express or implied, to any intellectual property right is granted by ST herein.

Resale of ST products with provisions different from the information set forth herein shall void any warranty granted by ST for such product.

ST and the ST logo are trademarks of ST. For additional information about ST trademarks, please refer to www.st.com/trademarks. All other product or service names are the property of their respective owners.

Information in this document supersedes and replaces information previously supplied in any prior versions of this document.

© 2019 STMicroelectronics – All rights reserved