

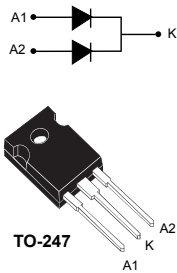

Automotive 100 V low drop power Schottky rectifier



Features

- AEC-Q101 qualified 
- PPAP capable
- Negligible switching losses
- High junction temperature capability
- Low leakage current
- Good trade-off between leakage current and forward voltage drop
- Avalanche capability specified
- Low thermal resistance

Application

- DC/DC converters
- Freewheeling diodes
- Electrical vehicles (EV) and hybrid electrical vehicles

Description

The **STPS61H100-Y** is a dual center tap Schottky rectifier designed for high frequency switched mode power supplies such as on board DC/DC converters for automotive applications.

Product status link

[STPS61H100-Y](#)

Product summary

$I_{F(AV)}$	2 x 30 A
V_{RRM}	100 V
$T_{j(max.)}$	175 °C
$V_{F(typ.)}$	0.63 V

1 Characteristics

Table 1. Absolute ratings (limiting values, per diode, at 25 °C unless otherwise specified)

Symbol	Parameter	Value	Unit
V _{RRM}	Repetitive peak reverse voltage	T _j = -40 to +175 °C	100 V
I _{F(RMS)}	Forward rms current		80 A
I _{F(AV)}	Average forward current, δ = 0.5 square wave	Per diode, T _c = 160 °C	30 A
		Per device, T _c = 160 °C	60 A
I _{FSM}	Surge non repetitive forward current	t _p = 10 ms sinusoidal	450 A
P _{ARM}	Repetitive peak avalanche power	t _p = 10 μs, T _j = 125 °C	1900 W
T _{stg}	Storage temperature range		-65 to +175 °C
T _j	Operating junction temperature range ⁽¹⁾		-40 to +175 °C

1. (dP_{tot}/dT_j) < (1/R_{th(j-a)}) condition to avoid thermal runaway for a diode on its own heatsink.

Table 2. Thermal resistance parameters

Symbol	Parameter	Typ. value	Unit
R _{th(j-c)}	Junction to case	Per diode	0.38 °C/W
		Per device	0.19 °C/W

Table 3. Static electrical characteristics (per diode)

Symbol	Parameter	Test conditions	Min.	Typ.	Max.	Unit
I _R ⁽¹⁾	Reverse leakage current	T _j = 25 °C	-	3	16	μA
		T _j = 125 °C	-	4	16	mA
V _F ⁽²⁾	Forward voltage drop	T _j = 25 °C	-	0.76	0.81	V
		T _j = 125 °C	-	0.63	0.7	
		T _j = 25 °C	-	0.87	0.93	
		T _j = 125 °C	-	0.75	0.83	

1. t_p = 5 ms, δ < 2%

2. t_p = 380 μs, δ < 2%

To evaluate the conduction losses, use the following equation:

$$P = 0.57 \times I_{F(AV)} + 0.0043 \times I_{F(RMS)}^2$$

1.1 Characteristics (curves)

Figure 1. Average forward current versus case temperature ($\delta = 0.5$, per diode)

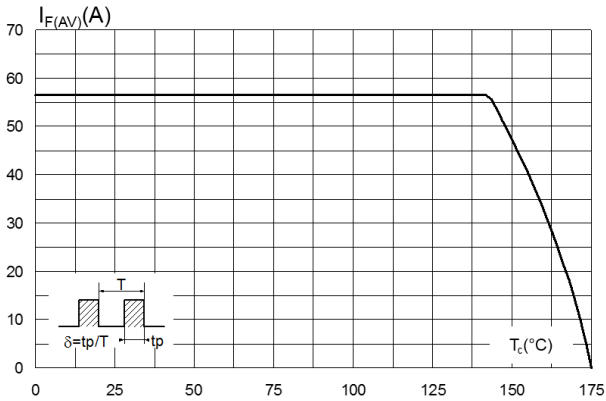

Figure 2. Relative variation of thermal impedance junction to case versus pulse duration

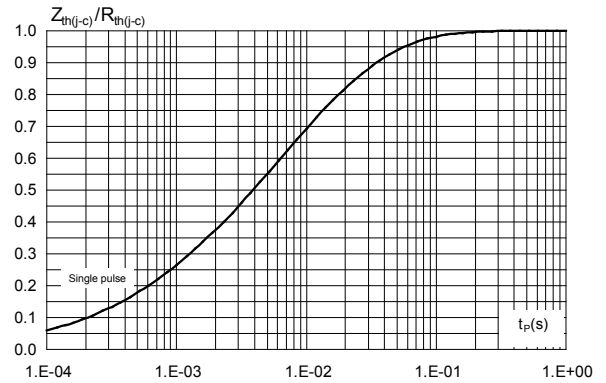

Figure 3. Reverse leakage current versus reverse voltage applied (typical values, per diode)

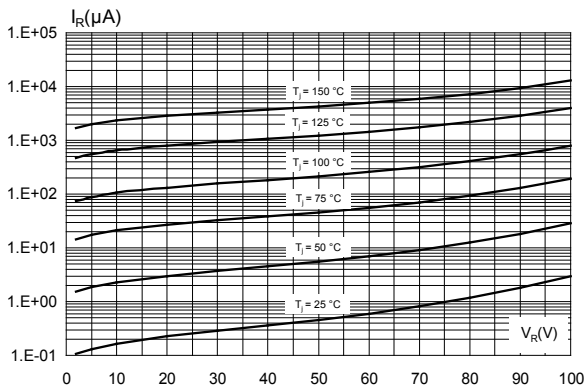

Figure 4. Junction capacitance versus reverse voltage applied (typical values, per diode)

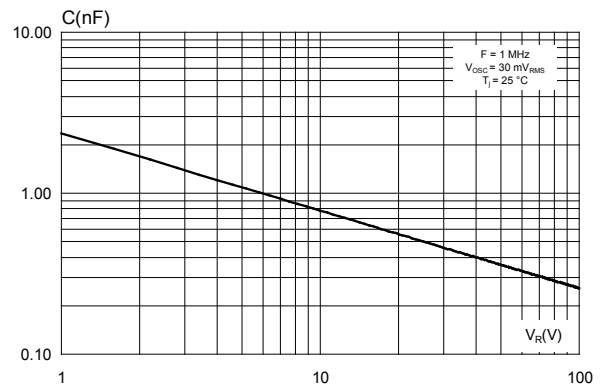

Figure 5. Normalized avalanche power derating versus pulse duration ($T_j = 125\text{ }^\circ\text{C}$)

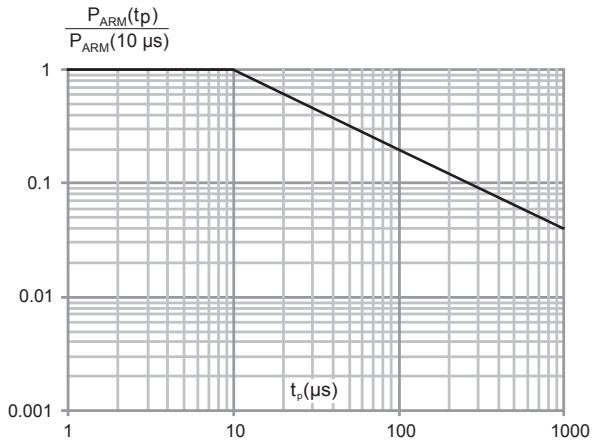
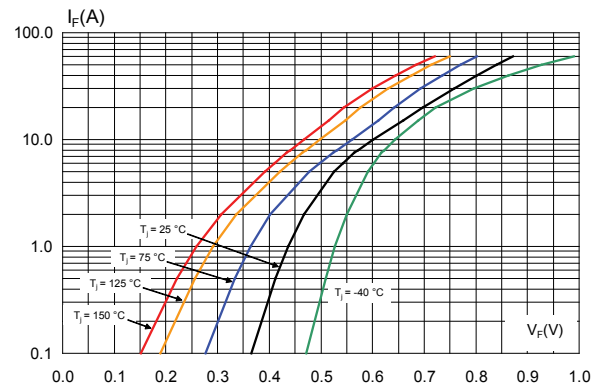

Figure 6. Forward voltage drop versus forward current (typical values, per diode)



2 Package information

In order to meet environmental requirements, ST offers these devices in different grades of **ECOPACK** packages, depending on their level of environmental compliance. ECOPACK specifications, grade definitions and product status are available at: www.st.com. ECOPACK is an ST trademark.

2.1 TO-247 package information

- Epoxy meets UL94, V0
- Cooling method: by conduction (C)
- Recommended torque value: 0.8 N·m
- Maximum torque value: 1.0 N·m

Figure 7. TO-247 package outline

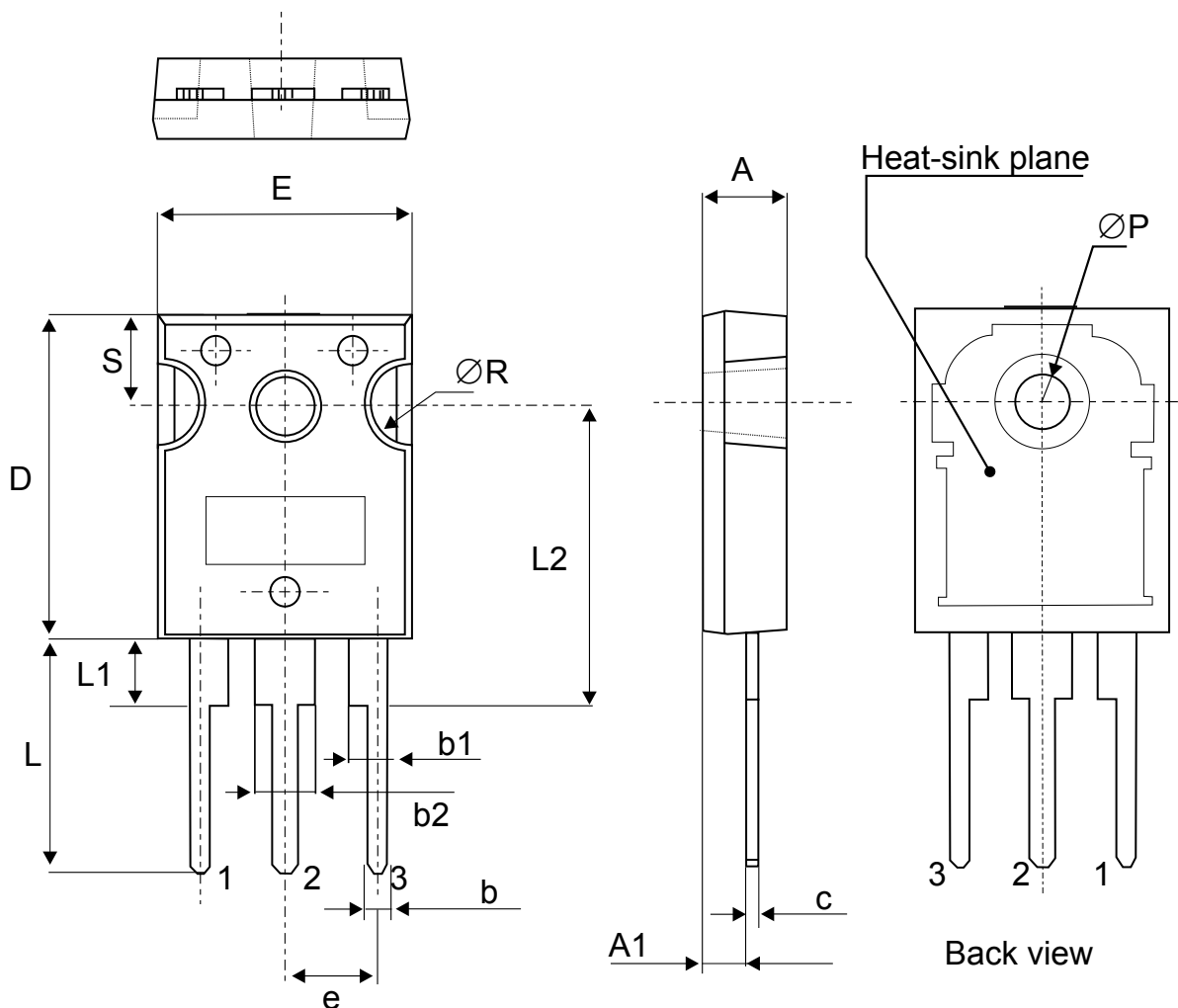

Table 4. TO-247 package mechanical data

Ref.	Dimensions					
	Millimeters			Inches (for reference only)		
	Min.	Typ.	Max.	Min.	Typ.	Max.
A	4.85		5.15	0.191		0.203
A1	2.20		2.60	0.086		0.102
b	1.00		1.40	0.039		0.055
b1	2.00		2.40	0.078		0.094
b2	3.00		3.40	0.118		0.133
c	0.40		0.80	0.015		0.031
D	19.85		20.15	0.781		0.793
E	15.45		15.75	0.608		0.620
e	5.30	5.45	5.60	0.209	0.215	0.220
L	14.20		14.80	0.559		0.582
L1	3.70		4.30	0.145		0.169
L2		18.50			0.728	
ØP	3.55		3.65	0.139		0.143
ØR	4.50		5.50	0.177		0.217
S	5.30	5.50	5.70	0.209	0.216	0.224

3 Ordering information

Table 5. Ordering information

Order code	Marking	Package	Weight	Base qty.	Delivery mode
STPS61H100CWY	STPS61H100CWY	TO-247	4.4 g	30	Tube

Revision history

Table 6. Document revision history

Date	Version	Changes
11-Jul-2019	1	Initial release.

IMPORTANT NOTICE – PLEASE READ CAREFULLY

STMicroelectronics NV and its subsidiaries (“ST”) reserve the right to make changes, corrections, enhancements, modifications, and improvements to ST products and/or to this document at any time without notice. Purchasers should obtain the latest relevant information on ST products before placing orders. ST products are sold pursuant to ST’s terms and conditions of sale in place at the time of order acknowledgement.

Purchasers are solely responsible for the choice, selection, and use of ST products and ST assumes no liability for application assistance or the design of Purchasers’ products.

No license, express or implied, to any intellectual property right is granted by ST herein.

Resale of ST products with provisions different from the information set forth herein shall void any warranty granted by ST for such product.

ST and the ST logo are trademarks of ST. For additional information about ST trademarks, please refer to www.st.com/trademarks. All other product or service names are the property of their respective owners.

Information in this document supersedes and replaces information previously supplied in any prior versions of this document.

© 2019 STMicroelectronics – All rights reserved