

N-channel 900 V, 0.91 Ω typ., 6 A MDmesh™ K5 Power MOSFET in an IPAK package

Datasheet - production data

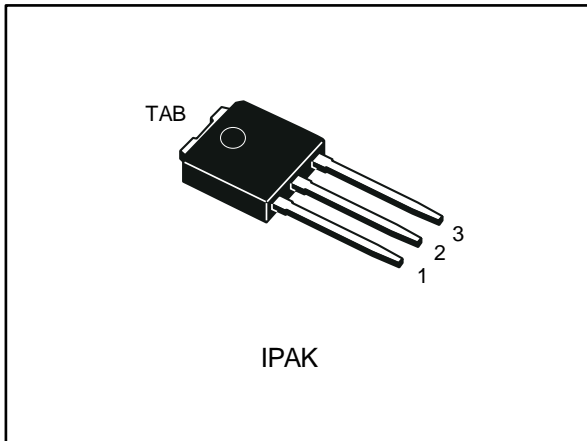
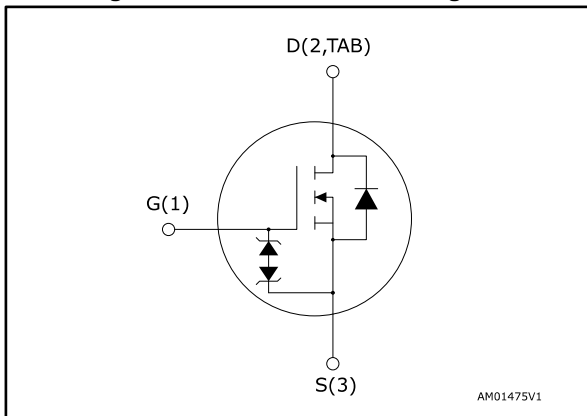

Figure 1: Internal schematic diagram



Features

Order code	V _{DS}	R _{DS(on)} max.	I _D
STU6N90K5	900 V	1.10 Ω	6 A

- Industry's lowest R_{DS(on)} x area
- Industry's best FoM (figure of merit)
- Ultra-low gate charge
- 100% avalanche tested
- Zener-protected

Applications

- Switching applications

Description

This very high voltage N-channel Power MOSFET is designed using MDmesh™ K5 technology based on an innovative proprietary vertical structure. The result is a dramatic reduction in on-resistance and ultra-low gate charge for applications requiring superior power density and high efficiency.

Table 1: Device summary

Order code	Marking	Package	Packing
STU6N90K5	6N90K5	IPAK	Tube

Contents

1	Electrical ratings	3
2	Electrical characteristics	4
	2.1 Electrical characteristics (curves).....	6
3	Test circuits	8
4	Package information	9
	4.1 IPAK (TO-251) type C package information.....	9
5	Revision history	11

1 Electrical ratings

Table 2: Absolute maximum ratings

Symbol	Parameter	Value	Unit
V_{GS}	Gate-source voltage	± 30	V
I_D	Drain current (continuous) at $T_C = 25\text{ }^\circ\text{C}$	6	A
I_D	Drain current (continuous) at $T_C = 100\text{ }^\circ\text{C}$	4	A
$I_D^{(1)}$	Drain current (pulsed)	24	A
P_{TOT}	Total dissipation at $T_C = 25\text{ }^\circ\text{C}$	110	W
$dv/dt^{(2)}$	Peak diode recovery voltage slope	4.5	V/ns
$dv/dt^{(3)}$	MOSFET dv/dt ruggedness	50	
T_j	Operating junction temperature range	- 55 to 150	$^\circ\text{C}$
T_{stg}	Storage temperature range		

Notes:

(1)Pulse width limited by safe operating area

(2) $I_{SD} \leq 6\text{ A}$, $di/dt \leq 100\text{ A}/\mu\text{s}$; $V_{DS\text{ peak}} < V_{(BR)DSS}$, $V_{DD} = 450\text{ V}$.

(3) $V_{DS} \leq 720\text{ V}$

Table 3: Thermal data

Symbol	Parameter	Value	Unit
$R_{thj-case}$	Thermal resistance junction-case	1.14	$^\circ\text{C}/\text{W}$
$R_{thj-amb}$	Thermal resistance junction-ambient	100	$^\circ\text{C}/\text{W}$

Table 4: Avalanche characteristics

Symbol	Parameter	Value	Unit
I_{AR}	Avalanche current, repetitive or not repetitive (pulse width limited by T_{jmax})	2	A
E_{AS}	Single pulse avalanche energy (starting $T_j = 25\text{ }^\circ\text{C}$, $I_D = I_{AR}$, $V_{DD} = 50\text{ V}$)	210	mJ

2 Electrical characteristics

$T_C = 25\text{ °C}$ unless otherwise specified

Table 5: On/off-state

Symbol	Parameter	Test conditions	Min.	Typ.	Max.	Unit
$V_{(BR)DSS}$	Drain-source breakdown voltage	$V_{GS} = 0\text{ V}$, $I_D = 1\text{ mA}$	900			V
I_{DSS}	Zero gate voltage drain current	$V_{GS} = 0\text{ V}$, $V_{DS} = 900\text{ V}$			1	μA
		$V_{GS} = 0\text{ V}$, $V_{DS} = 900\text{ V}$ $T_C = 125\text{ °C}^{(1)}$			50	μA
I_{GSS}	Gate body leakage current	$V_{DS} = 0\text{ V}$, $V_{GS} = \pm 20\text{ V}$			± 10	μA
$V_{GS(th)}$	Gate threshold voltage	$V_{DD} = V_{GS}$, $I_D = 100\text{ }\mu\text{A}$	3	4	5	V
$R_{DS(on)}$	Static drain-source on-resistance	$V_{GS} = 10\text{ V}$, $I_D = 3\text{ A}$		0.91	1.10	Ω

Notes:

⁽¹⁾ Defined by design, not subject to production test.

Table 6: Dynamic

Symbol	Parameter	Test conditions	Min.	Typ.	Max.	Unit
C_{iss}	Input capacitance	$V_{DS} = 100\text{ V}$, $f = 1\text{ MHz}$, $V_{GS} = 0\text{ V}$	-	342	-	pF
C_{oss}	Output capacitance		-	31	-	pF
C_{riss}	Reverse transfer capacitance		-	1.2	-	pF
$C_{o(tr)}^{(1)}$	Equivalent capacitance time related	$V_{DS} = 0\text{ to }720\text{ V}$, $V_{GS} = 0\text{ V}$	-	55	-	pF
$C_{o(er)}^{(2)}$	Equivalent capacitance energy related		-	20	-	pF
R_g	Intrinsic gate resistance	$f = 1\text{ MHz}$, $I_D = 0\text{ A}$	-	6.4	-	Ω
Q_g	Total gate charge	$V_{DD} = 720\text{ V}$, $I_D = 6\text{ A}$ $V_{GS} = 10\text{ V}$ (see Figure 15: "Test circuit for gate charge behavior")	-	11	-	nC
Q_{gs}	Gate-source charge		-	2.5	-	nC
Q_{gd}	Gate-drain charge		-	7	-	nC

Notes:

⁽¹⁾ $C_{o(tr)}$ is a constant capacitance value that gives the same charging time as C_{oss} while V_{DS} is rising from 0 to 80% V_{DSS} .

⁽²⁾ $C_{o(er)}$ is a constant capacitance value that gives the same stored energy as C_{oss} while V_{DS} is rising from 0 to 80% V_{DSS} .

Table 7: Switching times

Symbol	Parameter	Test conditions	Min.	Typ.	Max.	Unit
$t_{d(on)}$	Turn-on delay time	$V_{DD} = 450 \text{ V}$, $I_D = 3 \text{ A}$, $R_G = 4.7 \Omega$ $V_{GS} = 10 \text{ V}$ (see Figure 14: "Test circuit for resistive load switching times" and Figure 19: "Switching time waveform")	-	12.4	-	ns
t_r	Rise time		-	12.2	-	ns
$t_{d(off)}$	Turn-off delay time		-	30.4	-	ns
t_f	Fall time		-	15.5	-	ns

Table 8: Source-drain diode

Symbol	Parameter	Test conditions	Min.	Typ.	Max.	Unit
I_{SD}	Source-drain current		-		6	A
$I_{SDM}^{(1)}$	Source-drain current (pulsed)		-		24	A
$V_{SD}^{(2)}$	Forward on voltage	$I_{SD} = 6 \text{ A}$, $V_{GS} = 0 \text{ V}$	-		1.5	V
t_{rr}	Reverse recovery time	$I_{SD} = 6 \text{ A}$, $di/dt = 100 \text{ A}/\mu\text{s}$, $V_{DD} = 60 \text{ V}$ (see Figure 16: "Test circuit for inductive load switching and diode recovery times")	-	342		ns
Q_{rr}	Reverse recovery charge		-	3.13		μC
I_{RRM}	Reverse recovery current		-	18.3		A
t_{rr}	Reverse recovery time	$I_{SD} = 6 \text{ A}$, $di/dt = 100 \text{ A}/\mu\text{s}$, $V_{DD} = 60 \text{ V}$, $T_j = 150 \text{ }^\circ\text{C}$ (see Figure 16: "Test circuit for inductive load switching and diode recovery times")	-	536		ns
Q_{rr}	Reverse recovery charge		-	4.42		μC
I_{RRM}	Reverse recovery current		-	16.5		A

Notes:

(1)Pulse width limited by safe operating area

(2)Pulsed: pulse duration = 300 μs , duty cycle 1.5%

Table 9: Gate-source Zener diode

Symbol	Parameter	Test conditions	Min.	Typ.	Max.	Unit
$V_{(BR)GSO}$	Gate-source breakdown voltage	$I_{GS} = \pm 1 \text{ mA}$, $I_D = 0 \text{ A}$	30	-	-	V

The built-in back-to-back Zener diodes are specifically designed to enhance the ESD performance of the device. The Zener voltage facilitates efficient and cost-effective device integrity protection, thus eliminating the need for additional external componentry.

2.1 Electrical characteristics (curves)

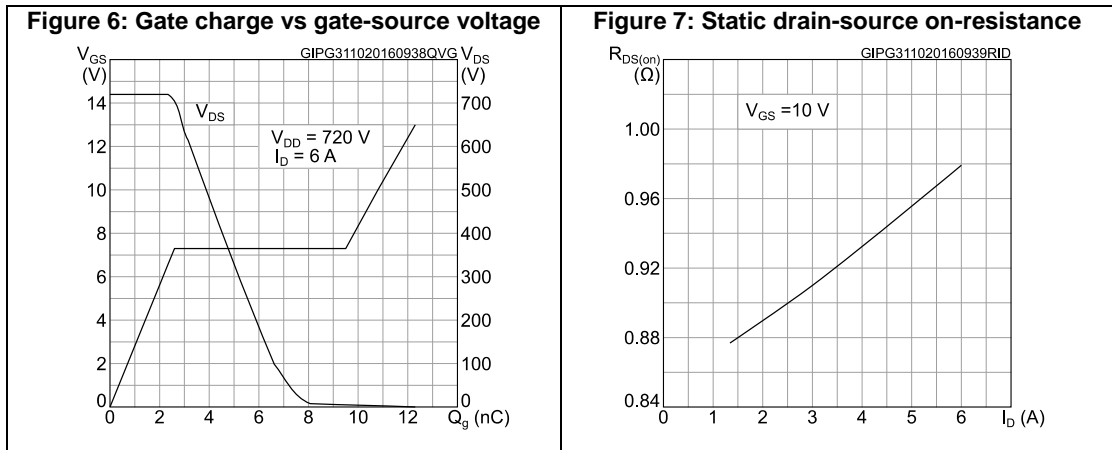
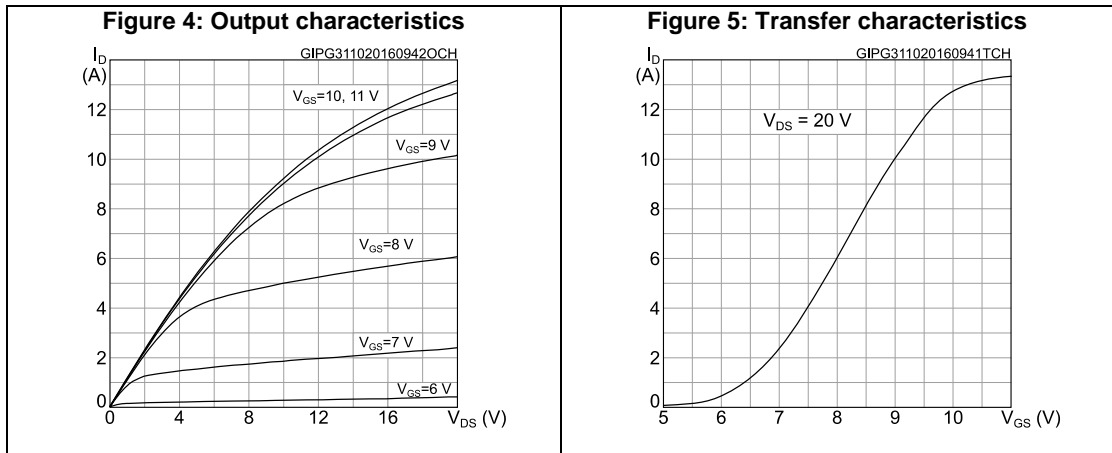
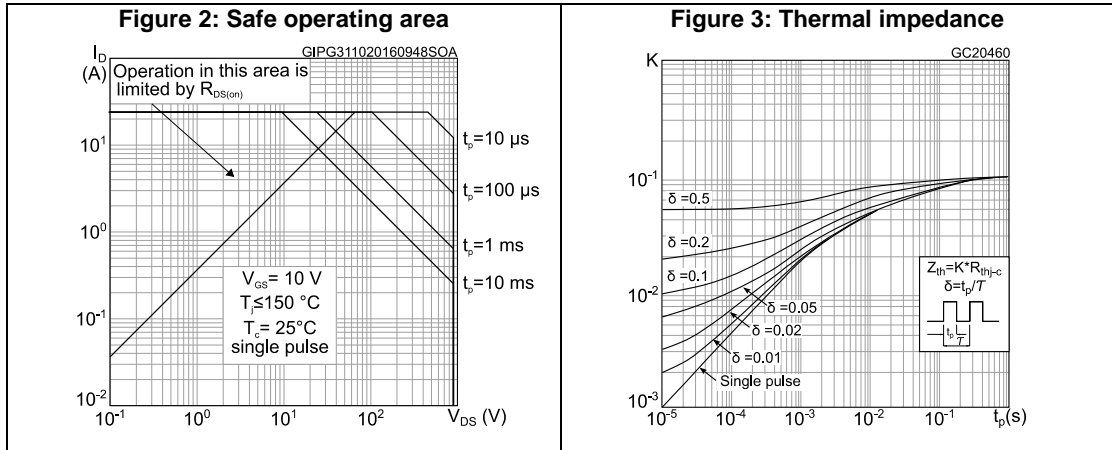

Figure 8: Capacitance variations

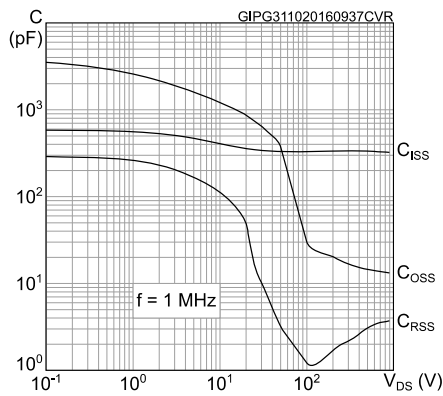

Figure 9: Normalized gate threshold voltage vs temperature

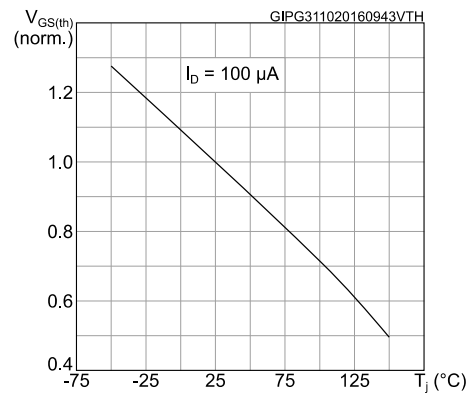

Figure 10: Normalized on-resistance vs temperature

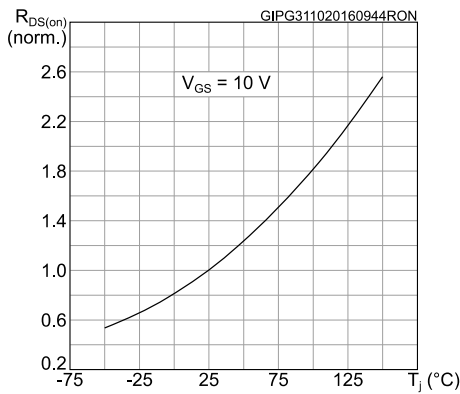

Figure 11: Normalized V_{(BR)DSS} vs temperature

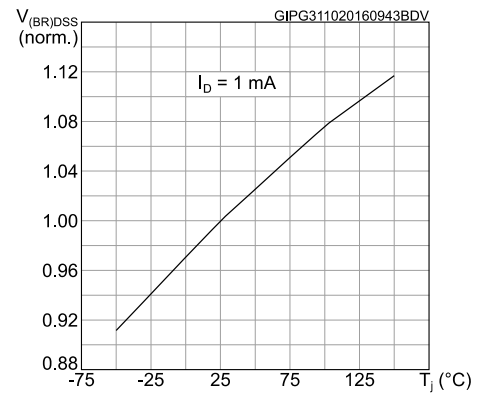

Figure 12: Maximum avalanche energy vs starting T_J

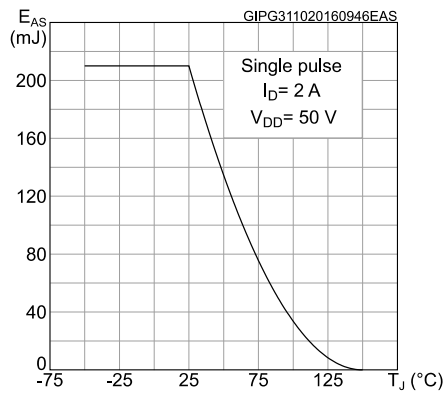
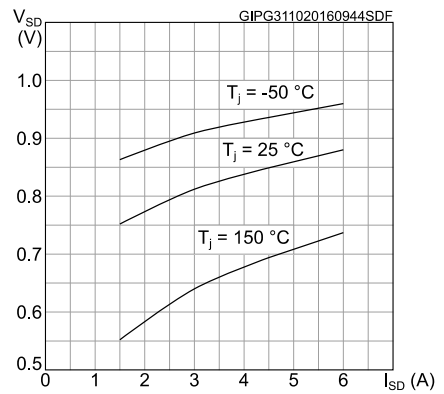
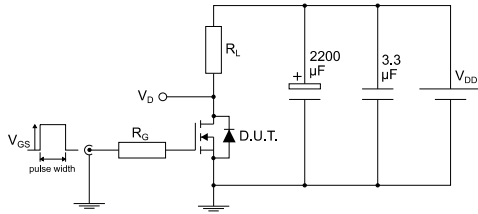

Figure 13: Source-drain diode forward characteristics



3 Test circuits

Figure 14: Test circuit for resistive load switching times



AM01468v1

Figure 15: Test circuit for gate charge behavior

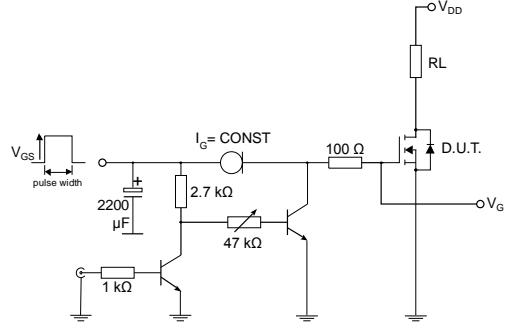

AM01469v10

Figure 16: Test circuit for inductive load switching and diode recovery times

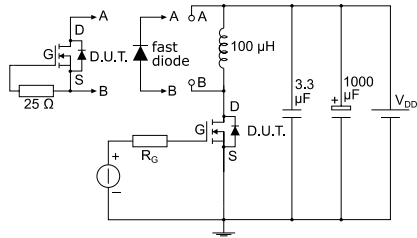

AM01470v1

Figure 17: Unclamped inductive load test circuit

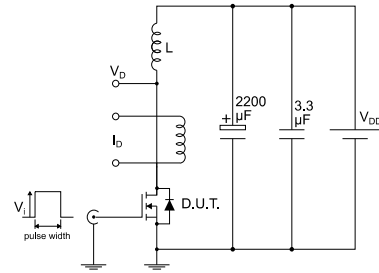

AM01471v1

Figure 18: Unclamped inductive waveform

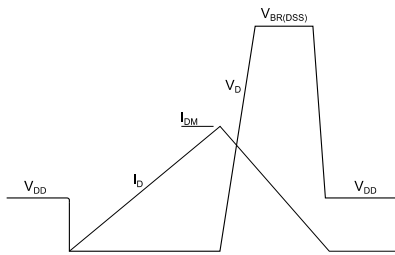

AM01472v1

Figure 19: Switching time waveform

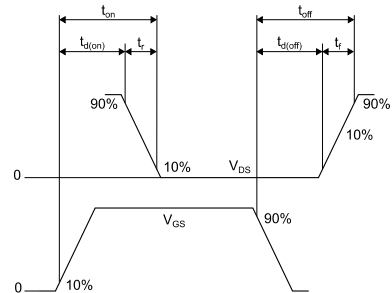

AM01473v1

4 Package information

In order to meet environmental requirements, ST offers these devices in different grades of ECOPACK® packages, depending on their level of environmental compliance. ECOPACK® specifications, grade definitions and product status are available at: www.st.com. ECOPACK® is an ST trademark.

4.1 IPAK (TO-251) type C package information

Figure 20: IPAK (TO-251) type C package outline

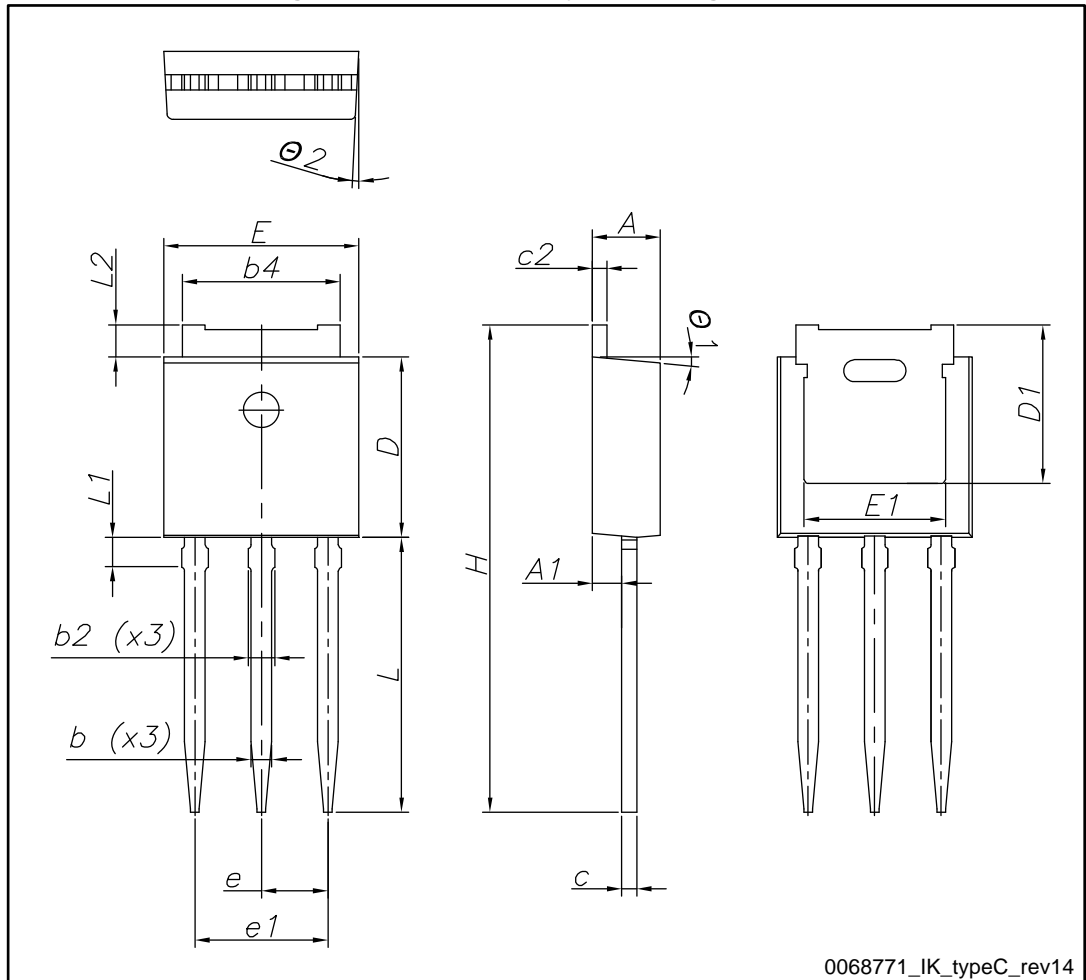

Table 10: IPAK (TO-251) type C package mechanical data

Dim.	mm		
	Min.	Typ.	Max.
A	2.20	2.30	2.35
A1	0.90	1.00	1.10
b	0.66		0.79
b2			0.90
b4	5.23	5.33	5.43
c	0.46		0.59
c2	0.46		0.59
D	6.00	6.10	6.20
D1	5.20	5.37	5.55
E	6.50	6.60	6.70
E1	4.60	4.78	4.95
e	2.20	2.25	2.30
e1	4.40	4.50	4.60
H	16.18	16.48	16.78
L	9.00	9.30	9.60
L1	0.90	1.00	1.20
L2	0.90	1.08	1.25
$\theta 1$	3°	5°	7°
$\theta 2$	1°	3°	5°

5 Revision history

Table 11: Document revision history

Date	Revision	Changes
02-Nov-2016	1	First release.

IMPORTANT NOTICE – PLEASE READ CAREFULLY

STMicroelectronics NV and its subsidiaries ("ST") reserve the right to make changes, corrections, enhancements, modifications, and improvements to ST products and/or to this document at any time without notice. Purchasers should obtain the latest relevant information on ST products before placing orders. ST products are sold pursuant to ST's terms and conditions of sale in place at the time of order acknowledgement.

Purchasers are solely responsible for the choice, selection, and use of ST products and ST assumes no liability for application assistance or the design of Purchasers' products.

No license, express or implied, to any intellectual property right is granted by ST herein.

Resale of ST products with provisions different from the information set forth herein shall void any warranty granted by ST for such product.

ST and the ST logo are trademarks of ST. All other product or service names are the property of their respective owners.

Information in this document supersedes and replaces information previously supplied in any prior versions of this document.

© 2016 STMicroelectronics – All rights reserved