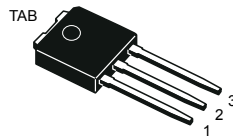
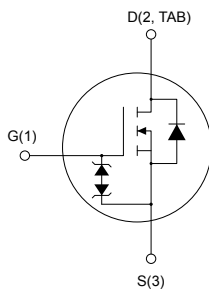

## N-channel 800 V, 0.95 $\Omega$ typ., 6 A MDmesh K5 Power MOSFET in an IPAK package

**IPAK**

AM01476v1\_tab

**Product status link**
[STU7N80K5](#)
**Product summary**

<b>Order code</b>	STU7N80K5
<b>Marking</b>	7N80K5
<b>Package</b>	IPAK
<b>Packing</b>	Tube

### Features

Order code	$V_{DS}$	$R_{DS(on)}$ max.	$I_D$
STU7N80K5	800 V	1.2 $\Omega$	6 A

- Industry's lowest  $R_{DS(on)}$  x area
- Industry's best FoM (figure of merit)
- Ultra-low gate charge
- 100% avalanche tested
- Zener-protected

### Applications

- Switching applications

### Description

This very high voltage N-channel Power MOSFET is designed using MDmesh K5 technology based on an innovative proprietary vertical structure. The result is a dramatic reduction in on-resistance and ultra-low gate charge for applications requiring superior power density and high efficiency.

# 1 Electrical ratings

**Table 1. Absolute maximum ratings**

Symbol	Parameter	Value	Unit
$V_{GS}$	Gate-source voltage	$\pm 30$	V
$I_D$	Drain current (continuous) at $T_C = 25\text{ }^\circ\text{C}$	6	A
	Drain current (continuous) at $T_C = 100\text{ }^\circ\text{C}$	3.8	
$I_{DM}^{(1)}$	Drain current (pulsed)	24	A
$P_{TOT}$	Total power dissipation at $T_C = 25\text{ }^\circ\text{C}$	110	W
$dv/dt^{(2)}$	Peak diode recovery voltage slope	4.5	V/ns
$dv/dt^{(3)}$	MOSFET $dv/dt$ ruggedness	50	V/ns
$T_{stg}$	Storage temperature range	-55 to 150	$^\circ\text{C}$
$T_J$	Operating junction temperature range		$^\circ\text{C}$

1. Pulse width is limited by safe operating area.
2.  $I_{SD} \leq 6\text{ A}$ ,  $di/dt \leq 100\text{ A}/\mu\text{s}$ ,  $V_{DS}(\text{peak}) < V_{(BR)DSS}$ .
3.  $V_{DS} \leq 640\text{ V}$ .

**Table 2. Thermal data**

Symbol	Parameter	Value	Unit
$R_{thJC}$	Thermal resistance, junction-to-case	1.14	$^\circ\text{C}/\text{W}$
$R_{thJA}$	Thermal resistance, junction-to-ambient	100	$^\circ\text{C}/\text{W}$

**Table 3. Avalanche characteristics**

Symbol	Parameter	Value	Unit
$I_{AR}$	Avalanche current, repetitive or non-repetitive (pulse width limited by $T_J$ max.)	2	A
$E_{AS}$	Single pulse avalanche energy (starting $T_J = 25\text{ }^\circ\text{C}$ , $I_D = I_{AR}$ , $V_{DD} = 50\text{ V}$ )	88	mJ

## 2 Electrical characteristics

$T_C = 25\text{ °C}$  unless otherwise specified.

**Table 4. On/off-state**

Symbol	Parameter	Test conditions	Min.	Typ.	Max.	Unit
$V_{(BR)DSS}$	Drain-source breakdown voltage	$V_{GS} = 0\text{ V}$ , $I_D = 1\text{ mA}$	800			V
$I_{DSS}$	Zero gate voltage drain current	$V_{DS} = 800\text{ V}$ , $V_{GS} = 0\text{ V}$			1	$\mu\text{A}$
		$V_{DS} = 800\text{ V}$ , $V_{GS} = 0\text{ V}$ , $T_C = 125\text{ °C}^{(1)}$			50	
$I_{GSS}$	Gate body leakage current	$V_{GS} = \pm 20\text{ V}$ , $V_{DS} = 0\text{ V}$			$\pm 10$	$\mu\text{A}$
$V_{GS(th)}$	Gate threshold voltage	$V_{DS} = V_{GS}$ , $I_D = 100\text{ }\mu\text{A}$	3	4	5	V
$R_{DS(on)}$	Static drain-source on-resistance	$V_{GS} = 10\text{ V}$ , $I_D = 3\text{ A}$		0.95	1.2	$\Omega$

1. Specified by design, not tested in production.

**Table 5. Dynamic**

Symbol	Parameter	Test conditions	Min.	Typ.	Max.	Unit
$C_{iss}$	Input capacitance	$V_{DS} = 100\text{ V}$ , $f = 1\text{ MHz}$ , $V_{GS} = 0\text{ V}$	-	360	-	pF
$C_{oss}$	Output capacitance		-	30	-	pF
$C_{rss}$	Reverse transfer capacitance		-	1	-	pF
$C_{o(tr)}^{(1)}$	Equivalent capacitance time related	$V_{GS} = 0\text{ V}$ , $V_{DS} = 0\text{ to }640\text{ V}$	-	47	-	pF
$C_{o(er)}^{(2)}$	Equivalent capacitance energy related		-	20	-	pF
$R_g$	Intrinsic gate resistance	$f = 1\text{ MHz}$ open drain	-	6	-	$\Omega$
$Q_g$	Total gate charge	$V_{DD} = 640\text{ V}$ , $I_D = 6\text{ A}$ , $V_{GS} = 0\text{ to }10\text{ V}$ (see Figure 15. Test circuit for gate charge behavior)	-	13.4	-	nC
$Q_{gs}$	Gate-source charge		-	3.7	-	nC
$Q_{gd}$	Gate-drain charge		-	7.5	-	nC

1.  $C_{o(tr)}$  is a constant capacitance value that gives the same charging time as  $C_{oss}$  while  $V_{DS}$  is rising from 0 to 80%  $V_{DSS}$ .

2.  $C_{o(er)}$  is a constant capacitance value that gives the same stored energy as  $C_{oss}$  while  $V_{DS}$  is rising from 0 to 80%  $V_{DSS}$ .

**Table 6. Switching times**

Symbol	Parameter	Test conditions	Min.	Typ.	Max.	Unit
$t_{d(on)}$	Turn-on delay time	$V_{DD} = 400\text{ V}$ , $I_D = 3\text{ A}$ , $R_G = 4.7\text{ }\Omega$ , $V_{GS} = 10\text{ V}$	-	11.3	-	ns
$t_r$	Rise time		-	8.3	-	ns
$t_{d(off)}$	Turn-off delay time	(see Figure 14. Test circuit for resistive load switching times and Figure 19. Switching time waveform)	-	23.7	-	ns
$t_f$	Fall time		-	20.2	-	ns

**Table 7. Source-drain diode**

Symbol	Parameter	Test conditions	Min.	Typ.	Max.	Unit
$I_{SD}$	Source-drain current		-		6	A
$I_{SDM}$	Source-drain current (pulsed)		-		24	A
$V_{SD}^{(1)}$	Forward on voltage	$I_{SD} = 6\text{ A}$ , $V_{GS} = 0\text{ V}$	-		1.5	V
$t_{rr}$	Reverse recovery time	$I_{SD} = 6\text{ A}$ , $di/dt = 100\text{ A}/\mu\text{s}$ ,	-	315		ns
$Q_{rr}$	Reverse recovery charge	$V_{DD} = 60\text{ V}$	-	2.8		$\mu\text{C}$
$I_{RRM}$	Reverse recovery current	(see Figure 16. Test circuit for inductive load switching and diode recovery times)	-	17.5		A
$t_{rr}$	Reverse recovery time	$I_{SD} = 6\text{ A}$ , $di/dt = 100\text{ A}/\mu\text{s}$ ,	-	480		ns
$Q_{rr}$	Reverse recovery charge	$V_{DD} = 60\text{ V}$ , $T_J = 150\text{ }^\circ\text{C}$	-	3.8		$\mu\text{C}$
$I_{RRM}$	Reverse recovery current	(see Figure 16. Test circuit for inductive load switching and diode recovery times)	-	16		A

1. Pulsed: pulse duration = 300  $\mu\text{s}$ , duty cycle 1.5%.

## 2.1 Electrical characteristics (curves)

**Figure 1. Safe operating area**

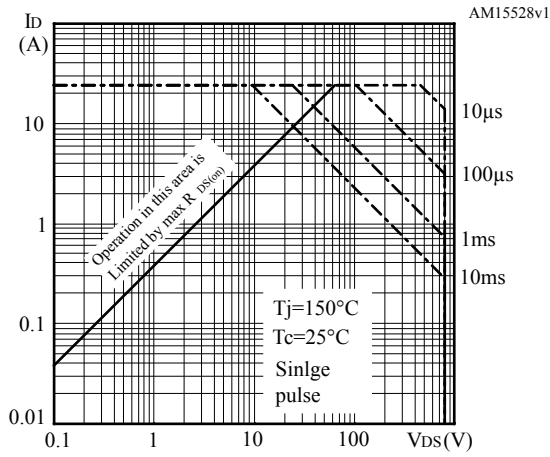

**Figure 2. Normalized transient thermal impedance**

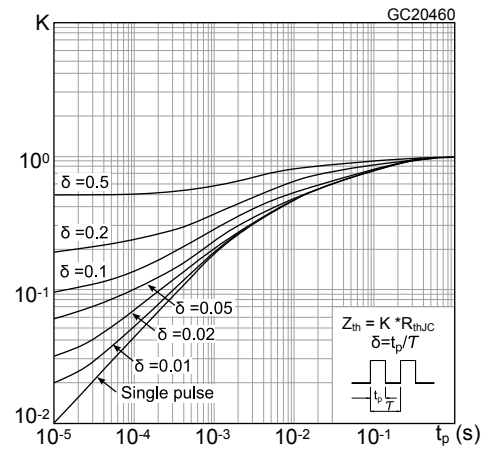

**Figure 3. Typical output characteristics**

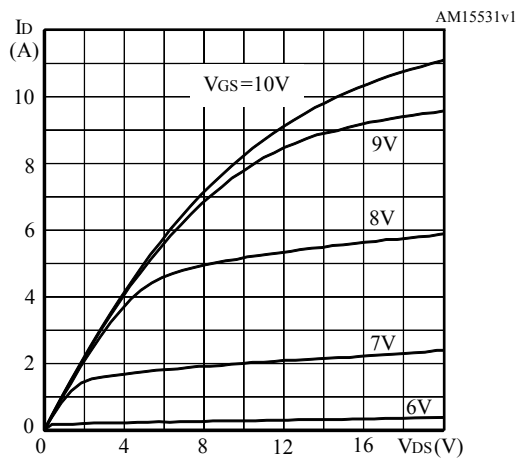

**Figure 4. Typical transfer characteristics**

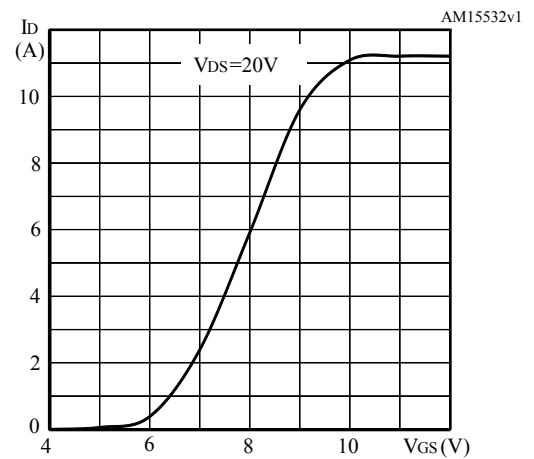

**Figure 5. Typical gate charge characteristics**

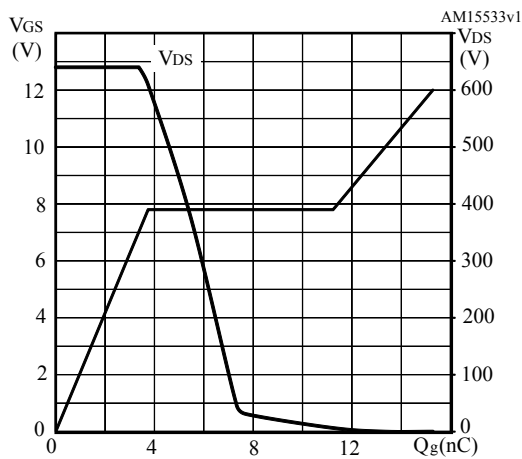

**Figure 6. Typical drain-source on-resistance**

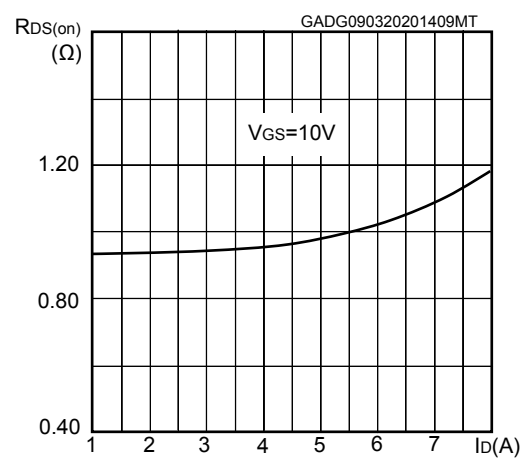

**Figure 7. Typical capacitance characteristics**

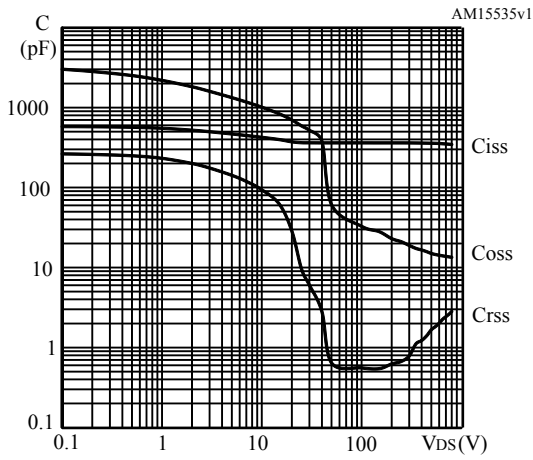

**Figure 8. Typical output capacitance stored energy**

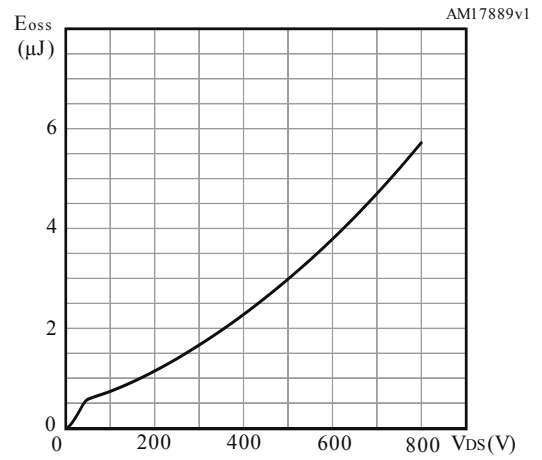

**Figure 9. Normalized gate threshold vs temperature**

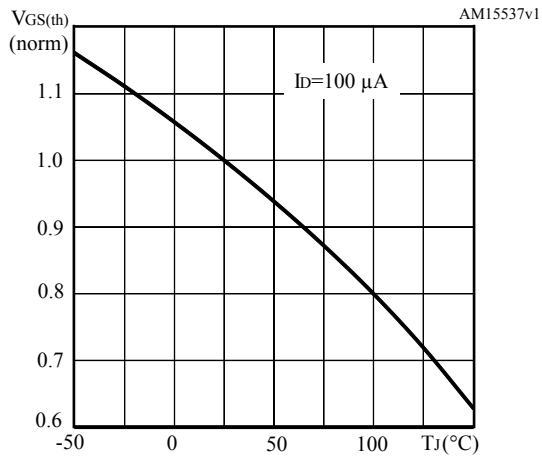

**Figure 10. Normalized on-resistance vs temperature**

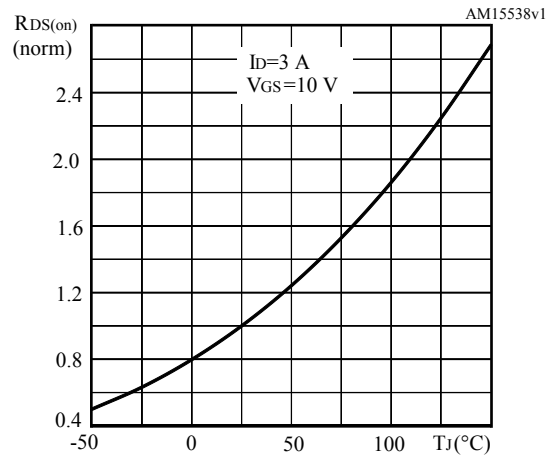

**Figure 11. Maximum avalanche energy vs starting Tj**

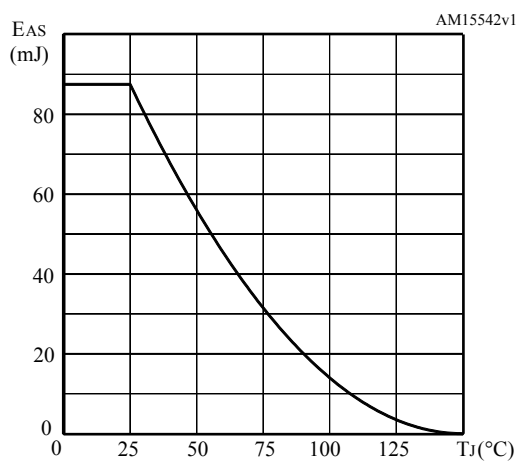

**Figure 12. Normalized breakdown voltage vs temperature**

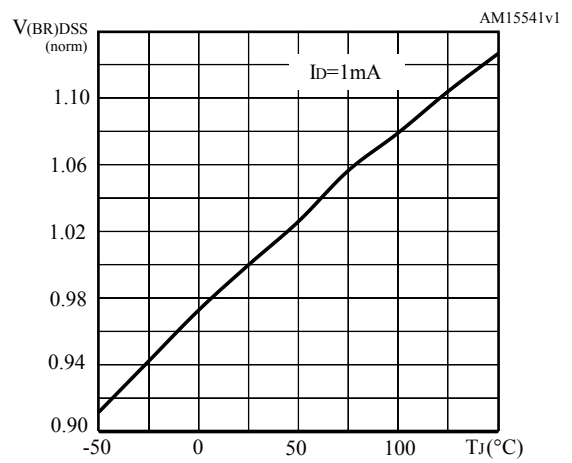

**Figure 13. Typical reverse diode forward characteristics**

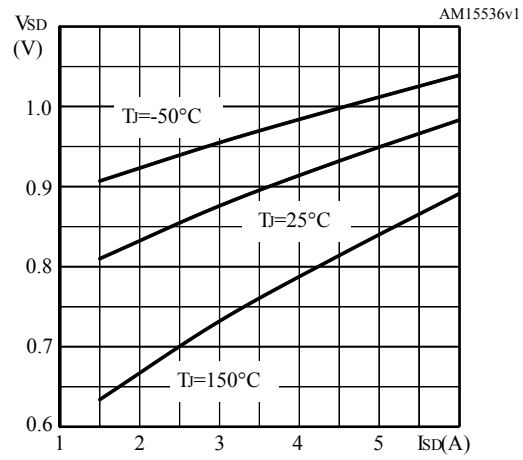

### 3 Test circuits

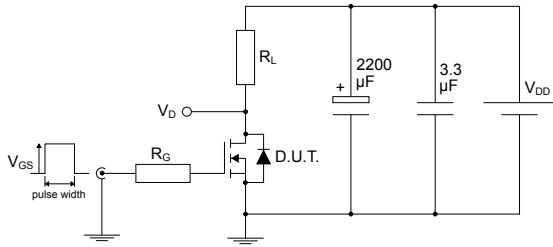
**Figure 14. Test circuit for resistive load switching times**

AM01468v1

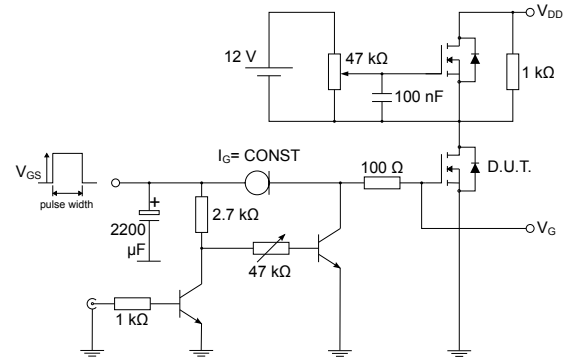
**Figure 15. Test circuit for gate charge behavior**

AM01469v1

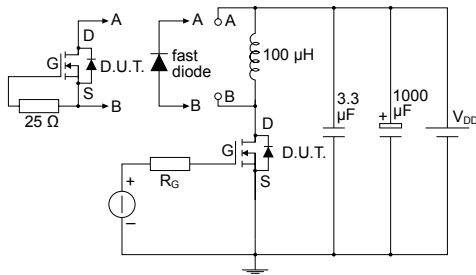
**Figure 16. Test circuit for inductive load switching and diode recovery times**

AM01470v1

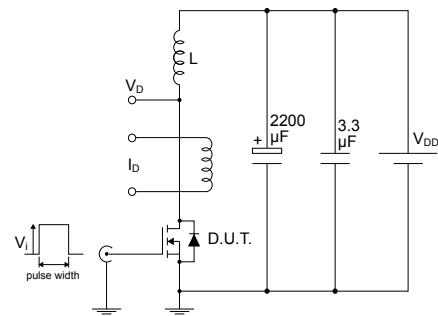
**Figure 17. Unclamped inductive load test circuit**

AM01471v1

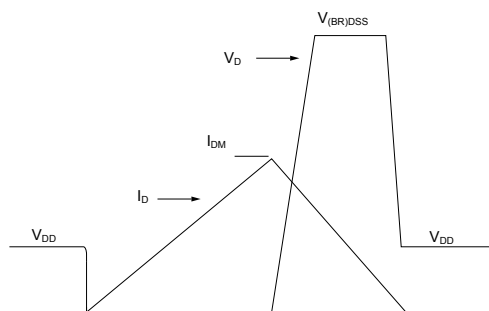
**Figure 18. Unclamped inductive waveform**

AM01472v1

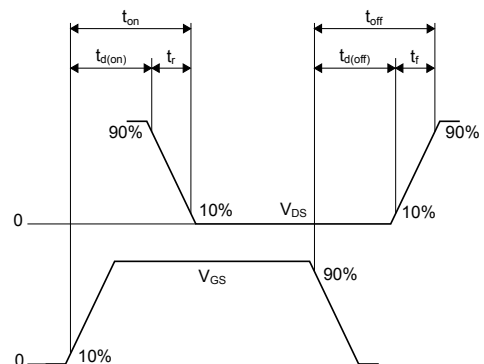
**Figure 19. Switching time waveform**

AM01473v1



## 4 Package information

In order to meet environmental requirements, ST offers these devices in different grades of **ECOPACK** packages, depending on their level of environmental compliance. ECOPACK specifications, grade definitions and product status are available at: [www.st.com](http://www.st.com). ECOPACK is an ST trademark.

### 4.1 IPAK (TO-251) type C package information

Figure 20. IPAK (TO-251) type C package outline

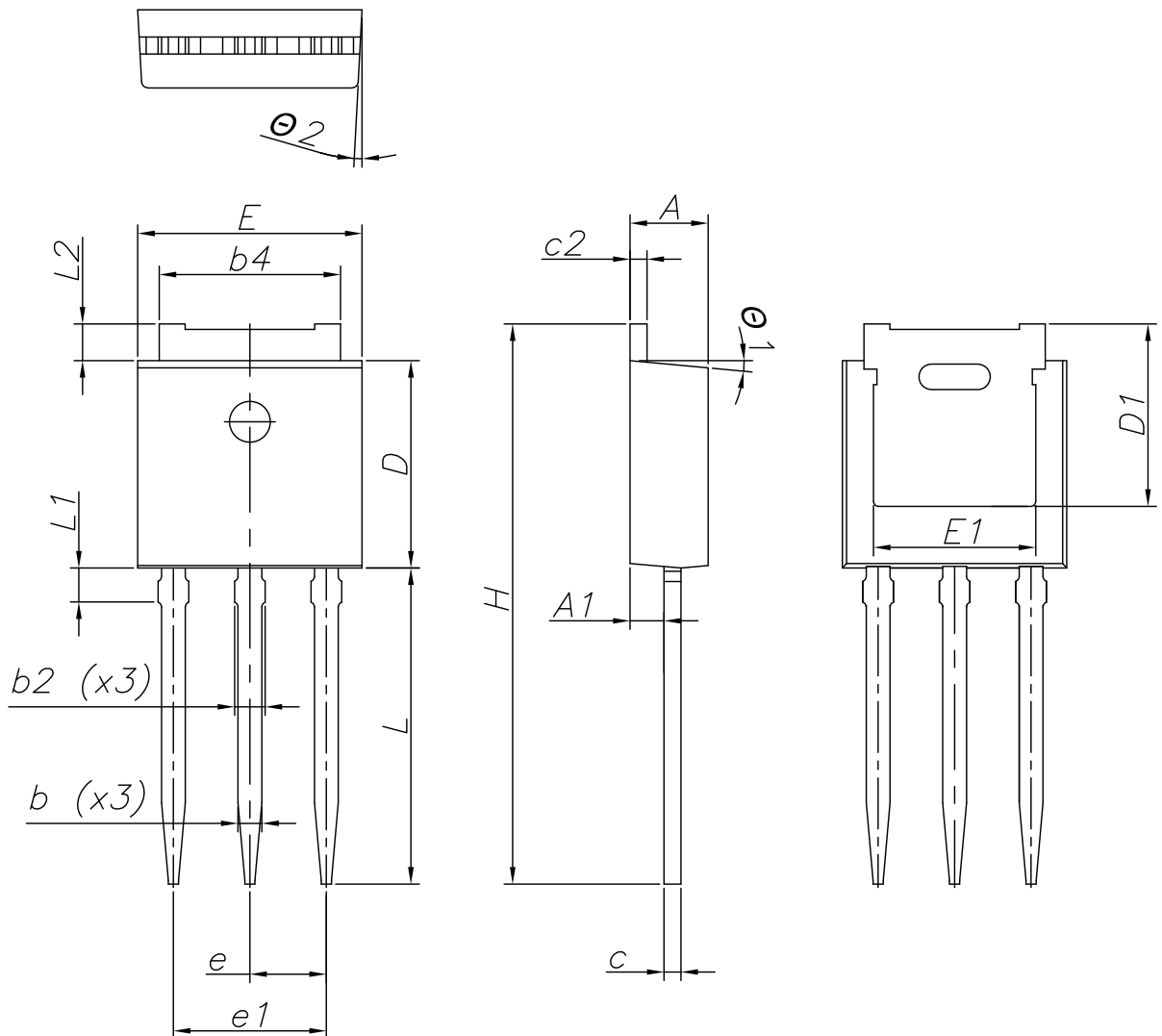

0068771\_IK\_typeC\_rev16

**Table 8. IPAK (TO-251) type C package mechanical data**

Dim.	mm		
	Min.	Typ.	Max.
A	2.20	2.30	2.35
A1	0.90	1.00	1.10
b	0.66		0.79
b2			0.90
b4	5.23	5.33	5.43
c	0.46		0.59
c2	0.46		0.59
D	6.00	6.10	6.20
D1	5.20	5.37	5.55
E	6.50	6.60	6.70
E1	4.60	4.78	4.95
e	2.20	2.25	2.30
e1	4.40	4.50	4.60
H	16.18	16.48	16.78
L	9.00	9.30	9.60
L1	0.80	1.00	1.20
L2	0.90	1.08	1.25
θ1	3°	5°	7°
θ2	1°	3°	5°

## Revision history

**Table 9. Document revision history**

Date	Revision	Changes
19-Sep-2023	1	First release. Part number STU7N80K5 previously included in datasheet DS9173.

---

## Contents

<b>1</b>	<b>Electrical ratings</b> .....	<b>2</b>
<b>2</b>	<b>Electrical characteristics</b> .....	<b>3</b>
<b>2.1</b>	<b>Electrical characteristics (curves)</b> .....	<b>5</b>
<b>3</b>	<b>Test circuits</b> .....	<b>8</b>
<b>4</b>	<b>Package information</b> .....	<b>9</b>
<b>4.1</b>	<b>IPAK (TO-251) type C package information</b> .....	<b>9</b>
	<b>Revision history</b> .....	<b>11</b>

**IMPORTANT NOTICE – READ CAREFULLY**

STMicroelectronics NV and its subsidiaries (“ST”) reserve the right to make changes, corrections, enhancements, modifications, and improvements to ST products and/or to this document at any time without notice. Purchasers should obtain the latest relevant information on ST products before placing orders. ST products are sold pursuant to ST’s terms and conditions of sale in place at the time of order acknowledgment.

Purchasers are solely responsible for the choice, selection, and use of ST products and ST assumes no liability for application assistance or the design of purchasers’ products.

No license, express or implied, to any intellectual property right is granted by ST herein.

Resale of ST products with provisions different from the information set forth herein shall void any warranty granted by ST for such product.

ST and the ST logo are trademarks of ST. For additional information about ST trademarks, refer to [www.st.com/trademarks](http://www.st.com/trademarks). All other product or service names are the property of their respective owners.

Information in this document supersedes and replaces information previously supplied in any prior versions of this document.

© 2023 STMicroelectronics – All rights reserved