

## 12 A logic level (sensitive) Triac

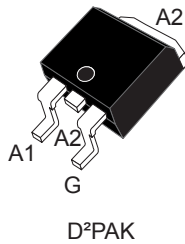

A2: Anode2  
A1: Anode1  
G: Gate

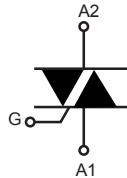

## Features

- High static  $dV/dt$
- High dynamic turn-off commutation  $(dI/dt)_c$
- 150 °C maximum junction temperature
- Three quadrants
- Surge capability  $V_{DSM}, V_{RSM} = 900\text{ V}$
- Benefits:
  - High immunity to false turn-on thanks to high static  $dV/dt$
  - Better turn-off in high temperature environments thanks to  $(dI/dt)_c$
  - Increase of thermal margin due to extended working  $T_j$  up to 150 °C
  - Good thermal resistance due to non-insulated tab.

## Applications

- General purpose AC line load switching
- Motor control circuits
- Small home appliances
- Lighting
- Inrush current limiting circuits
- Overvoltage crowbar protection

## Product status link

[T1210T-8G](#)

## Product summary

$I_{T(RMS)}$	12 A
$V_{DRM}/V_{RRM}$	800 V
$V_{DSM}/V_{RSM}$	900 V
$I_{GT}$	10 mA

## Description

Available in SMD, the T1210T-8G Triac can be used for the on/off or phase angle control function in general purpose AC switching where high commutation capability is required. This device can be used without a snubber RC circuit when the limits defined are respected.

D<sup>2</sup>PAK Package is UL-94,V0 flammability resin compliance.

Package environmentally friendly [Ecopack2](#) graded (RoHS and Halogen Free compliance).

# 1 Characteristics

**Table 1. Absolute maximum ratings (limiting values),  $T_j = 25\text{ °C}$  unless otherwise specified**

Symbol	Parameter		Value	Unit
$V_{DRM}/V_{RRM}$	Repetitive peak off-state voltage (50-60 Hz)	$T_j = 125\text{ °C}$	800	V
		$T_j = 150\text{ °C}$	600	V
$V_{DSM}/V_{RSM}$	Non Repetitive peak off-state voltage	$t_p = 10\text{ ms}$ , $T_j = 25\text{ °C}$	900	V
$I_{T(RMS)}$	RMS on-state current (full sine wave)	$T_c = 131\text{ °C}$	12	A
$I_{TSM}$	Non repetitive surge peak on-state current (full cycle, $T_j$ initial = $25\text{ °C}$ )	$t = 16.7\text{ ms}$	105	A
		$t = 20\text{ ms}$	100	
$I^2t$	$I^2t$ value for fusing	$t_p = 10\text{ ms}$	66	$A^2s$
$di/dt$	Critical rate of rise of on-state current, $I_G = 2 \times I_{GT}$ , $tr \leq 100\text{ ns}$	$f = 100\text{ Hz}$	100	$A/\mu s$
$I_{GM}$	Peak gate current	$t_p = 20\text{ }\mu s$ , $T_j = 150\text{ °C}$	4	A
$V_{GM}$	Peak Gate Voltage		5	V
$P_{G(AV)}$	Average gate power dissipation	$T_j = 150\text{ °C}$	1	W
$T_{stg}$	Storage junction temperature range		-40 to +150	$^{\circ}C$
$T_j$	Operating junction temperature range		-40 to +150	$^{\circ}C$

**Table 2. Electrical characteristics ( $T_j = 25\text{ °C}$ , unless otherwise specified)**

Symbol	Test conditions	Quadrants; $T_j$		Value	Unit
$I_{GT}^{(1)}$	$V_D = 12\text{ V}$ , $R_L = 30\text{ }\Omega$	I - II - III	Max.	10	mA
$V_{GT}$	$V_D = 12\text{ V}$ , $R_L = 30\text{ }\Omega$	I - II - III	Max.	1	V
$V_{GD}$	$V_D = 800\text{ V}$ , $R_L = 3.3\text{ k}\Omega$ $T_j = 125\text{ °C}$	I - II - III	Min.	0.15	V
$I_L$	$I_G = 1.2 \times I_{GT}$	I - III	Max.	30	mA
	$I_G = 1.2 \times I_{GT}$	II	Max.	35	mA
$I_H^{(2)}$	$I_T = 500\text{ mA}$ , gate open		Max.	25	mA
$dV/dt^{(2)}$	$V_D = 536\text{ V}$ , gate open	$T_j = 125\text{ °C}$	Min.	200	$V/\mu s$
	$V_D = 402\text{ V}$ , gate open	$T_j = 150\text{ °C}$	Min.	150	$V/\mu s$
$(di/dt)_c^{(2)}$	$(dV/dt)_c = 0.1\text{ V}/\mu s$	$T_j = 125\text{ °C}$	Min.	20	A/ms
		$T_j = 150\text{ °C}$		14.4	
	$(dV/dt)_c = 10\text{ V}/\mu s$	$T_j = 125\text{ °C}$	Min.	6	A/ms
		$T_j = 150\text{ °C}$		3.8	

1. Minimum  $I_{GT}$  is guaranteed at 5% of  $I_{GT\text{ max}}$
2. For both polarities of A2 referenced to A1.

**Table 3. Static characteristics**

Symbol	Test conditions	$T_j$		Value	Unit
$V_{TM}^{(1)}$	$I_T = 16.9\text{ A}$ , $t_p = 380\ \mu\text{s}$	25 °C	Max.	1.55	V
$V_{TO}^{(1)}$	Threshold on-state voltage	150 °C	Max.	0.81	V
$R_D^{(1)}$	Dynamic resistance	150 °C	Max.	40	m $\Omega$
$I_{DRM}/I_{RRM}$	$V_{DRM} = V_{RRM} = 800\text{ V}$	25 °C	Max.	7.5	$\mu\text{A}$
		125 °C		1.0	mA
	$V_{DRM} = V_{RRM} = 600\text{ V}$	150 °C	Max.	3.3	mA

1. For both polarities of A2 referenced to A1.

**Table 4. Thermal resistance**

Symbol	Parameter			Value	Unit
$R_{th(j-c)}$	Junction to case (AC)	D <sup>2</sup> PAK	Max.	1.3	°C/W

## 1.1 Characteristics (curves)

**Figure 1. Maximum power dissipation versus on-state RMS current**

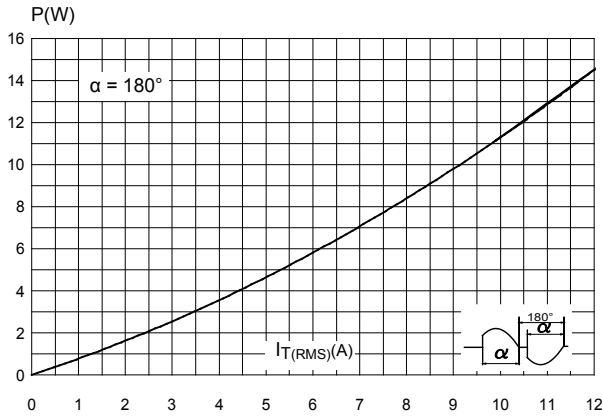

**Figure 2. On-state RMS current versus case temperature**

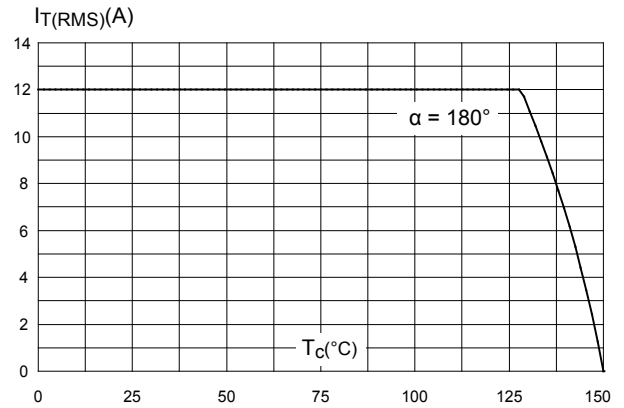

**Figure 3. On-state RMS current versus ambient temperature (free air convection)**

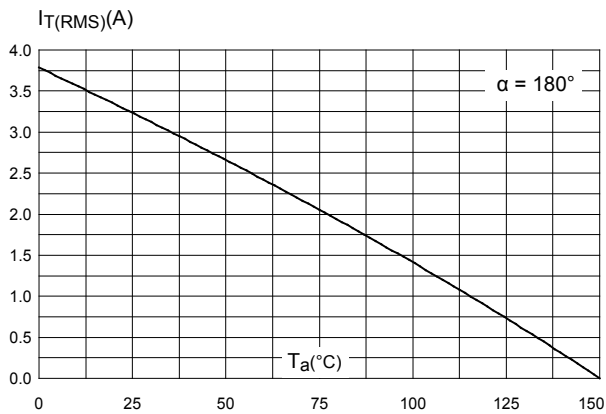

**Figure 4. Relative variation of thermal impedance versus pulse duration**

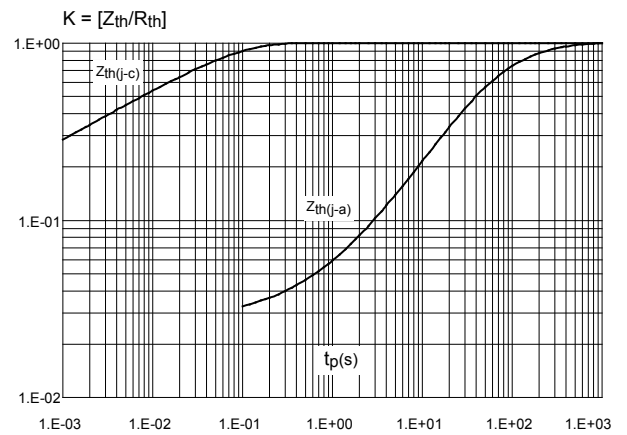

**Figure 5. Relative variation of gate trigger voltage and current versus junction temperature (typical values)**

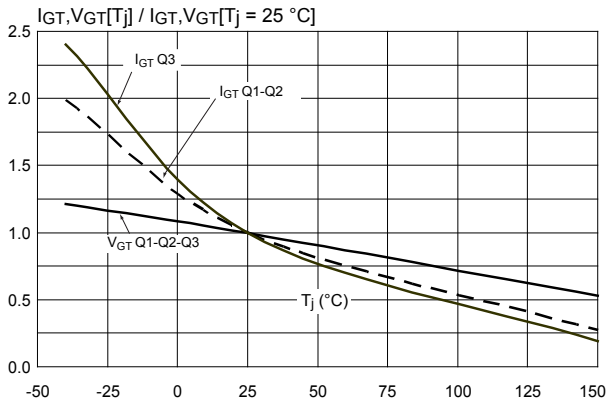

**Figure 6. Relative variation of holding current and latching current versus junction temperature (typical values)**

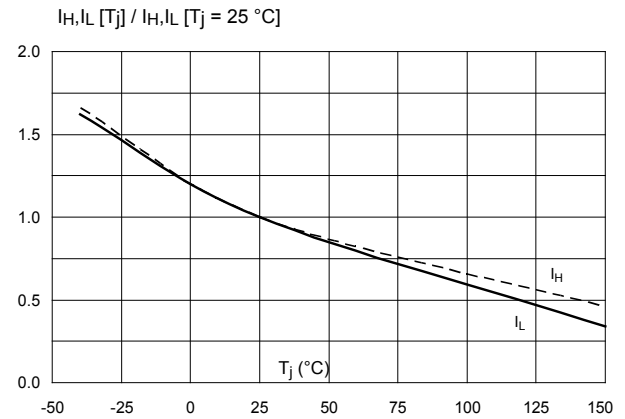

**Figure 7. Surge peak on-state current versus number of cycles**

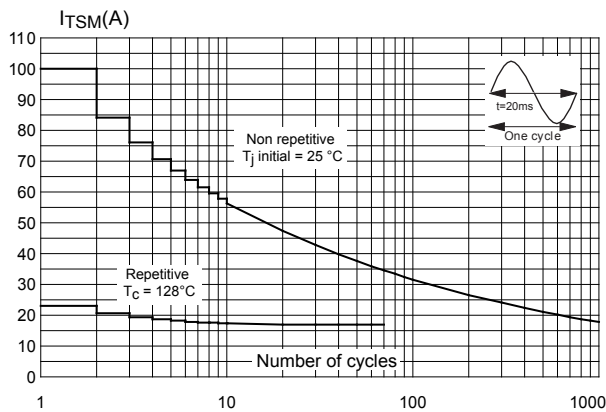

**Figure 8. Non repetitive surge peak on-state current for a sinusoidal pulse with width  $t_p < 10$  ms**

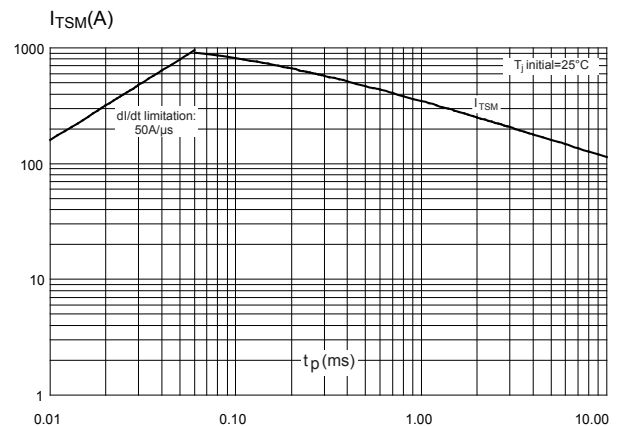

**Figure 9. On-state characteristics (maximum values)**

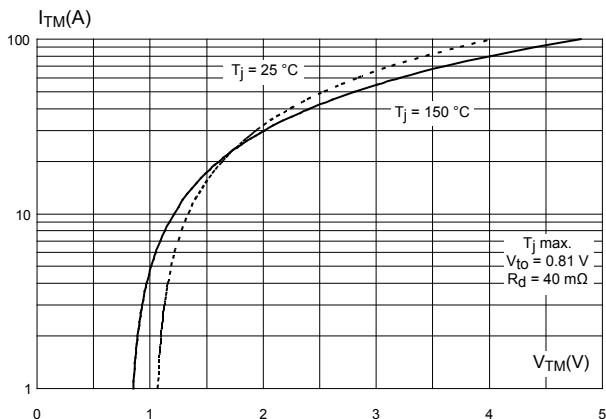

**Figure 10. Relative variation of critical rate of decrease of main voltage versus junction temperature**

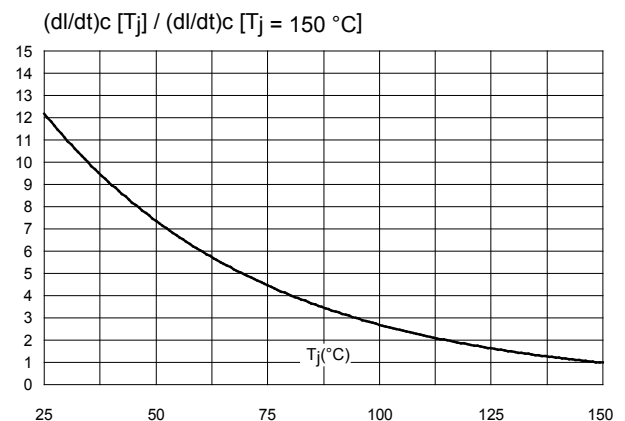

**Figure 11. Relative variation of static dV/dt immunity versus junction temperature**

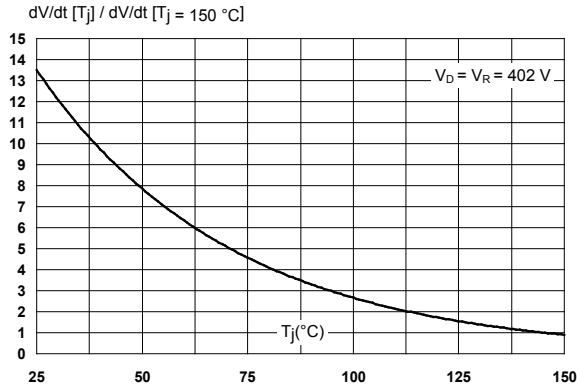

**Figure 12. Relative variation of critical rate of decrease of main current versus reapplied dV/dt (typical values)**

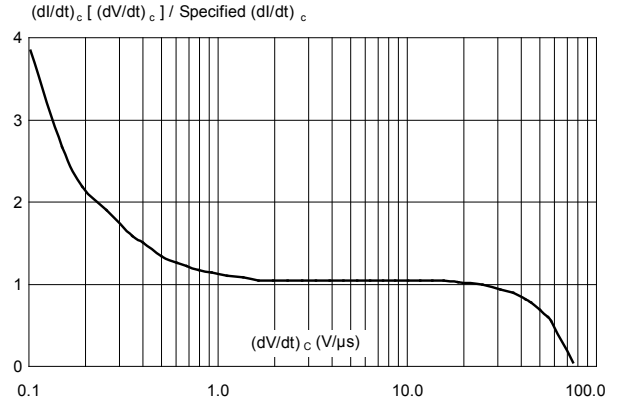

**Figure 13. Relative variation of leakage current versus junction temperature for different values of blocking voltage**

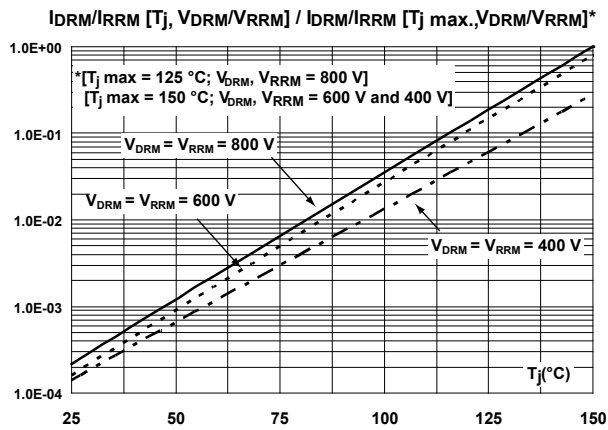

## 2 Ordering information

Figure 14. Ordering information scheme

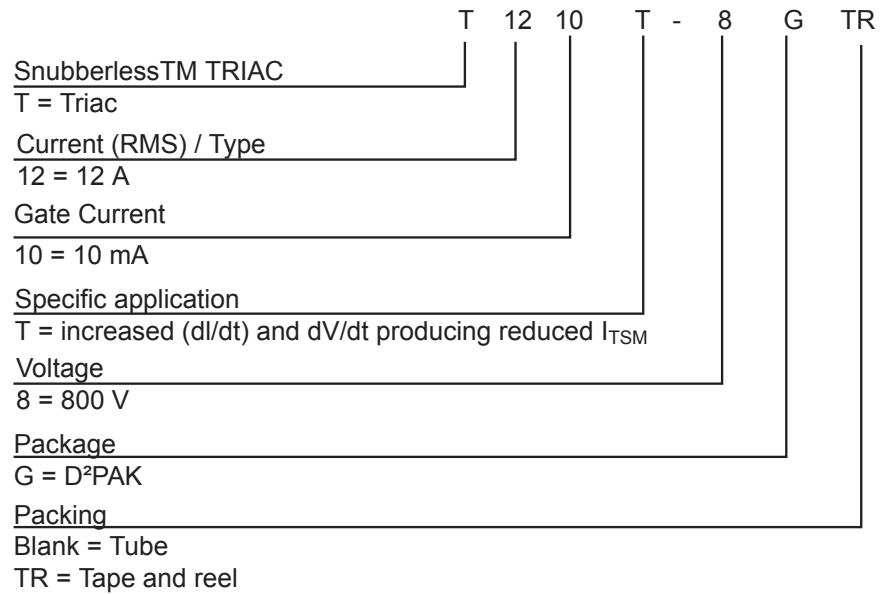

Table 5. Ordering information

Order code	Marking	Package	Weight	Base qty.	Delivery mode
T1210T-8G-TR	T1210T-8G	D <sup>2</sup> PAK	1.38 g	1000	Tape and reel
T1210T-8G				50	Tube

### 3 Package information

In order to meet environmental requirements, ST offers these devices in different grades of **ECOPACK** packages, depending on their level of environmental compliance. ECOPACK specifications, grade definitions and product status are available at: [www.st.com](http://www.st.com). ECOPACK is an ST trademark.

#### 3.1 D<sup>2</sup>PAK package information

- **ECOPACK2** compliant
- Lead-free package leads finishing
- Molding compound resin is halogen-free and meets UL standard level V0

Figure 15. D<sup>2</sup>PAK package outline

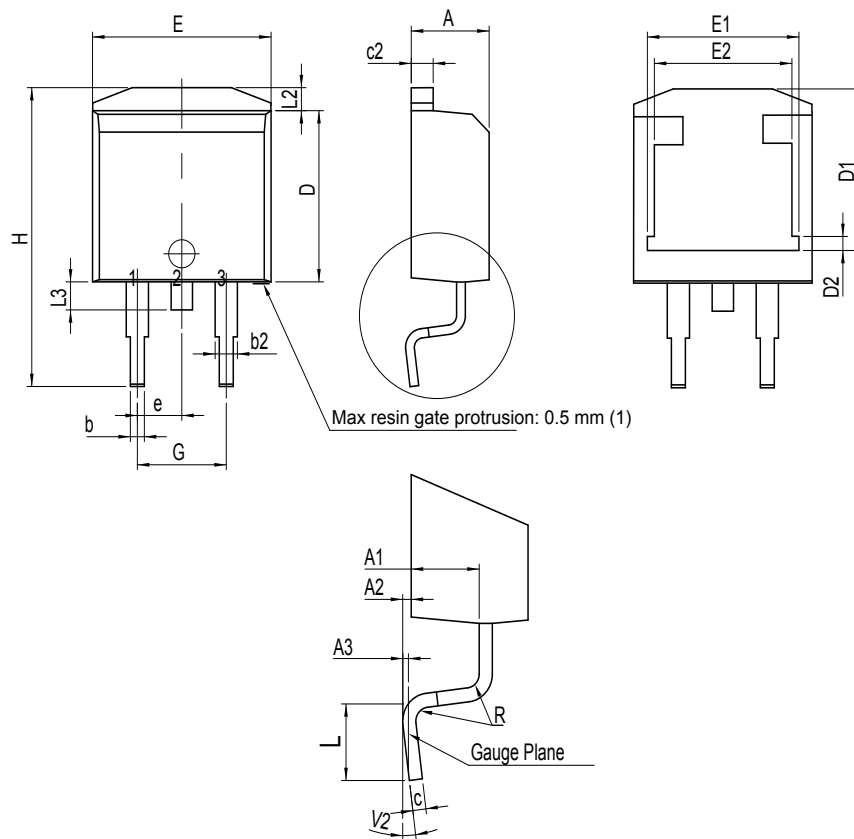

(1) Resin gate is accepted in each of position shown on the drawing, or their symmetrical.



Table 6. D<sup>2</sup>PAK package mechanical data

Ref.	Dimensions					
	Millimeters			Inches <sup>1</sup>		
	Min.	Typ.	Max.	Min.	Typ.	Max.
A	4.30		4.60	0.1693		0.1811
A1	2.49		2.69	0.0980		0.1059
A2	0.03		0.23	0.0012		0.0091
A3		0.25			0.0098	
b	0.70		0.93	0.0276		0.0366
b2	1.25		1.7	0.0492		0.0669
c	0.45		0.60	0.0177		0.0236
c2	1.21		1.36	0.0476		0.0535
D	8.95		9.35	0.3524		0.3681
D1	7.50		8.00	0.2953		0.3150
D2	1.30		1.70	0.0512		0.0669
e		2.54			0.1	
E	10.00		10.28	0.3937		0.4047
E1	8.30		8.70	0.3268		0.3425
E2	6.85		7.25	0.2697		0.2854
G	4.88		5.28	0.1921		0.2079
H	15		15.85	0.5906		0.6240
L	1.78		2.28	0.0701		0.0898
L2	1.27		1.40	0.0500		0.0551
L3	1.40		1.75	0.0551		0.0689
R		0.40			0.0157	
V22	0°		8°	0°		8°

1. Dimensions in inches are given for reference only
2. Degrees

Figure 16. D<sup>2</sup>PAK recommended footprint (dimensions are in mm)

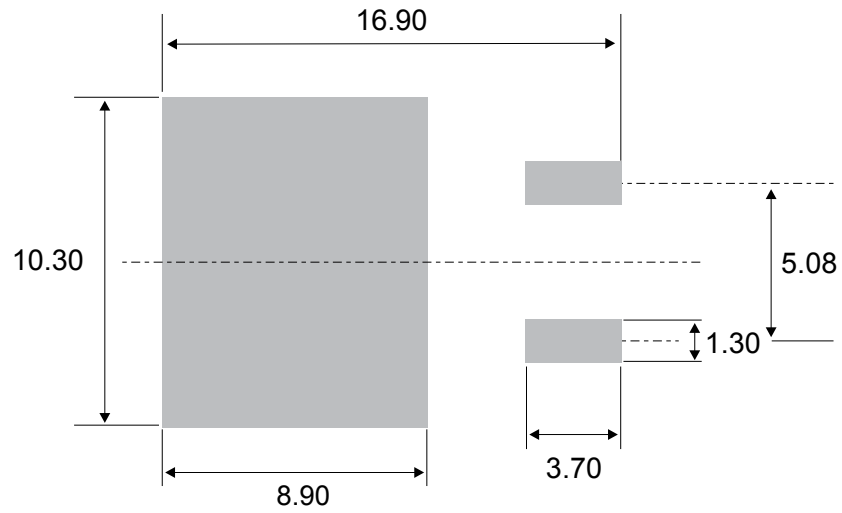
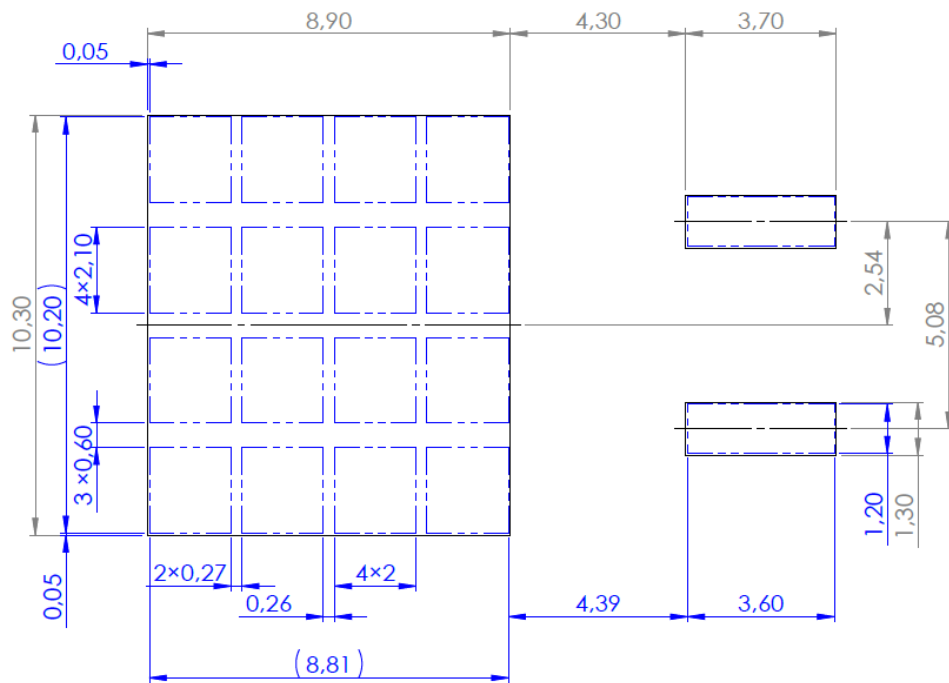

Figure 17. D<sup>2</sup>PAK stencil definitions (dimensions are in mm)



## Revision history

**Table 7. Document revision history**

Date	Version	Changes
05-Aug-2019	1	Initial release.
01-Oct-2019	2	Updated Table 1. Absolute maximum ratings (limiting values), $T_j = 25\text{ }^\circ\text{C}$ unless otherwise specified and Table 4. Thermal resistance.

**IMPORTANT NOTICE – PLEASE READ CAREFULLY**

STMicroelectronics NV and its subsidiaries (“ST”) reserve the right to make changes, corrections, enhancements, modifications, and improvements to ST products and/or to this document at any time without notice. Purchasers should obtain the latest relevant information on ST products before placing orders. ST products are sold pursuant to ST’s terms and conditions of sale in place at the time of order acknowledgement.

Purchasers are solely responsible for the choice, selection, and use of ST products and ST assumes no liability for application assistance or the design of Purchasers’ products.

No license, express or implied, to any intellectual property right is granted by ST herein.

Resale of ST products with provisions different from the information set forth herein shall void any warranty granted by ST for such product.

ST and the ST logo are trademarks of ST. For additional information about ST trademarks, please refer to [www.st.com/trademarks](http://www.st.com/trademarks). All other product or service names are the property of their respective owners.

Information in this document supersedes and replaces information previously supplied in any prior versions of this document.

© 2019 STMicroelectronics – All rights reserved