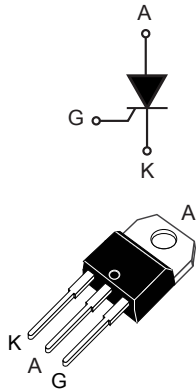

## 30 A 800 V high temperature SCR thyristors in TO-220AB package

**TO-220AB**

### Features

- High junction temperature:  $T_j = 150\text{ °C}$
- $800\text{ V } V_{DRM} / V_{RRM}$
- $900\text{ V } V_{DSM} / V_{RSM}$
- Low  $I_{GT}$ : 15 mA
- High static immunity  $dV/dt = 1000\text{ V}/\mu\text{s}$  at  $150\text{ °C}$
- High turn-on rise  $dI/dt$  at  $200\text{ A}/\mu\text{s}$
- Halogen-free molding, lead-free plating
- ECOPACK2 compliant

### Application

- Inrush current limiting circuits in AC/DC converters
- General purpose AC line load switching
- Heating resistor control, solid state relays

### Description

Thanks to its junction temperature  $T_j$  up to  $150\text{ °C}$ , the **TN3015H-8T** offers high thermal performance operation up to 30 A RMS in a TO-220AB package.

Its trade-off noise immunity ( $dV/dt = 1000\text{ V}/\mu\text{s}$ ) versus its gate triggering current ( $I_{GT} = 15\text{ mA}$ ) and its turn-on current rise ( $dI/dt = 200\text{ A}/\mu\text{s}$ ) allow to design robust and compact control circuit in AC/DC converters for inrush current limiting circuits and industrial drives, such as overvoltage crowbar protection, motor control circuits and power tools.

#### Product status

TN3015H-8T

#### Product summary

Order code	TN3015H-8T
Package	TO-220AB
$I_{T(RMS)}$	30 A
$V_{DRM}/V_{RRM}$	800 V
$T_j$ (max.)	$150\text{ °C}$

# 1 Characteristics

**Table 1. Absolute maximum ratings (limiting values),  $T_j = 25\text{ °C}$  unless otherwise specified**

Symbol	Parameter		Value	Unit
$I_{T(RMS)}$	RMS on-state current (180 ° conduction angle)	$T_c = 129\text{ °C}$	30	A
$I_{T(AV)}$	Average on-state current (180 ° conduction angle)	$T_c = 129\text{ °C}$	19	A
		$T_c = 135\text{ °C}$	15	
		$T_c = 140\text{ °C}$	11	
$I_{TSM}$	Non repetitive surge peak on-state current ( $T_j$ initial = 25 °C)	$t_p = 8.3\text{ ms}$	329	A
		$t_p = 10\text{ ms}$	300	
$I^2t$	$I^2t$ value for fusing	$t_p = 10\text{ ms}$	450	$A^2s$
$di/dt$	$I_G = 2 \times I_{GT}$ , $tr \leq 100\text{ ns}$ Critical rate of rise of on-state current	$f = 50\text{ Hz}$	200	$A/\mu s$
$V_{DRM}/V_{RRM}$	Repetitive peak off-state voltage	$T_j = 150\text{ °C}$	800	V
$V_{DSM}/V_{RSM}$	Non repetitive surge peak off-state voltage	$t_p = 10\text{ ms}$	900	V
$I_{GM}$	Peak gate current	$t_p = 20\text{ }\mu s$ , $T_j = 150\text{ °C}$	4	A
$P_{G(AV)}$	Average gate power dissipation	$T_j = 150\text{ °C}$	1	W
$V_{RGM}$	Maximum peak reverse gate voltage		5	V
$T_{stg}$	Storage junction temperature range		-40 to +150	°C
$T_j$	Maximum operating junction temperature		-40 to +150	°C
$T_l$	Maximum lead temperature soldering during 10 s		260	°C

**Table 2. Electrical characteristics ( $T_j = 25\text{ °C}$  unless otherwise specified)**

Symbol	Test conditions		Value	Unit	
$I_{GT}$	$V_D = 12\text{ V}$ , $R_L = 33\text{ }\Omega$	Min.	5	mA	
		Max.	15		
$V_{GT}$		Max.	1.3	V	
$V_{GD}$	$V_D = V_{DRM}$ , $R_L = 3.3\text{ k}\Omega$	$T_j = 150\text{ °C}$	Min.	0.2	V
$I_H$	$I_T = 500\text{ mA}$ , gate open		Max.	50	mA
$I_L$	$I_G = 1.2 \times I_{GT}$		Max.	70	mA
$dV/dt$	$V_D = 536\text{ V}$ , gate open	$T_j = 150\text{ °C}$	Min.	1000	$V/\mu s$
$t_{gt}$	$I_{TM} = 60\text{ A}$ , $V_D = 536\text{ V}$ , $I_G = 30\text{ mA}$ , $(di_G/dt) = 0.2\text{ A}/\mu s$		Typ.	1.9	$\mu s$
$t_q$	$I_T = 60\text{ A}$ , $t_p = 100\text{ }\mu s$ , $(di/dt)_{OFF} = 10\text{ A}/\mu s$ , $V_D = 536\text{ V}$ , $V_R = 25\text{ V}$ , $dV_D/dt = 40\text{ V}/\mu s$	$T_j = 125\text{ °C}$	Typ.	70	$\mu s$
		$T_j = 150\text{ °C}$	Typ.	85	$\mu s$

**Table 3. Static characteristics**

Symbol	Test conditions			Value	Unit
$V_{TM}$	$I_{TM} = 60 \text{ A}$ , $t_p = 380 \mu\text{s}$	$T_j = 25 \text{ }^\circ\text{C}$	Max.	1.55	V
$V_{TO}$	Threshold voltage	$T_j = 150 \text{ }^\circ\text{C}$	Max.	0.85	
$R_D$	Dynamic resistance	$T_j = 150 \text{ }^\circ\text{C}$	Max.	12	m $\Omega$
$I_{DRM}$ , $I_{RRM}$	$V_D = V_{DRM}$ , $V_R = V_{RRM}$	$T_j = 25 \text{ }^\circ\text{C}$	Max.	1.8	$\mu\text{A}$
		$T_j = 150 \text{ }^\circ\text{C}$		7	mA

**Table 4. Thermal parameters**

Symbol	Parameter	Value	Unit
$R_{th(j-c)}$	Junction to case (DC)	Max.	0.8
$R_{th(j-a)}$	Junction to ambient	Typ.	60

## 1.1 Characteristics (curves)

**Figure 1. Maximum average power dissipation versus average on-state current**

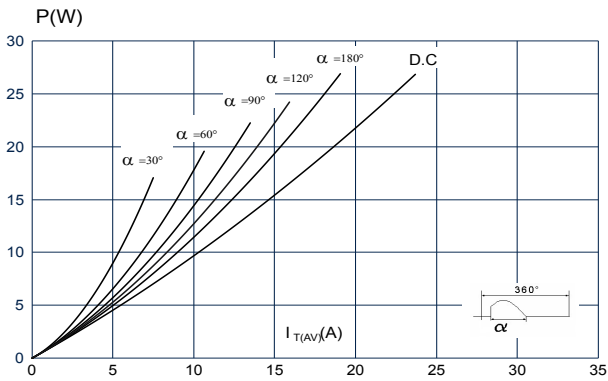

**Figure 2. Average and DC on-state current versus case temperature**

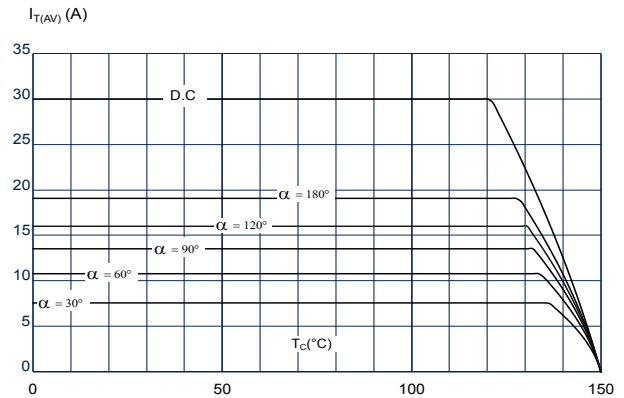

**Figure 3. Average and D.C. on state current versus ambient temperature**

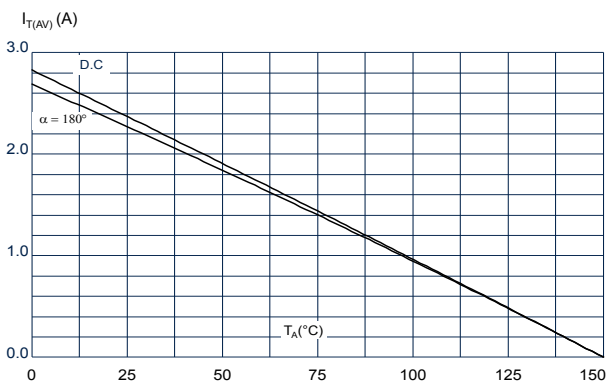

**Figure 4. Relative variation of thermal impedance junction to case and junction to ambient versus pulse duration**

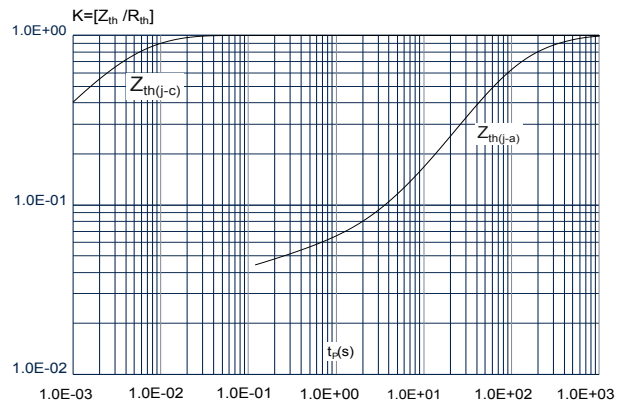

**Figure 5. Relative variation of gate trigger current and gate voltage versus junction temperature**

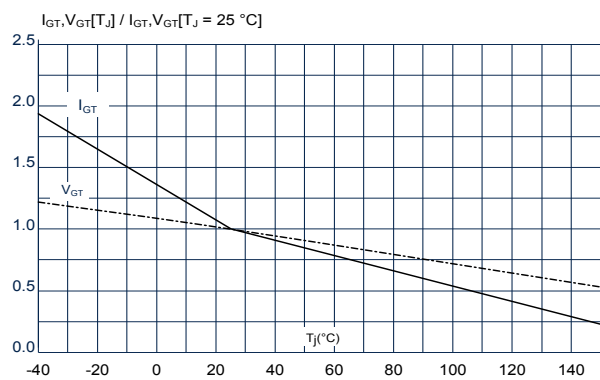

**Figure 6. Relative variation of holding and latching current versus junction temperature**

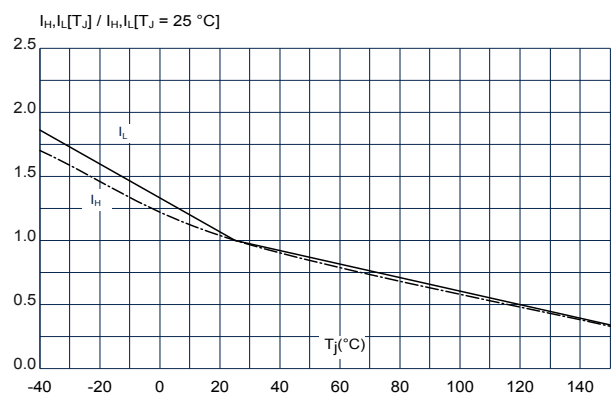

**Figure 7. Relative variation of static dV/dt immunity versus junction temperature**

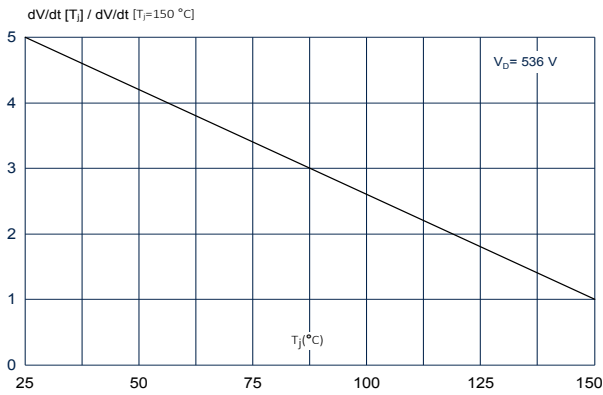

**Figure 8. Surge peak on-state current versus number of cycles**

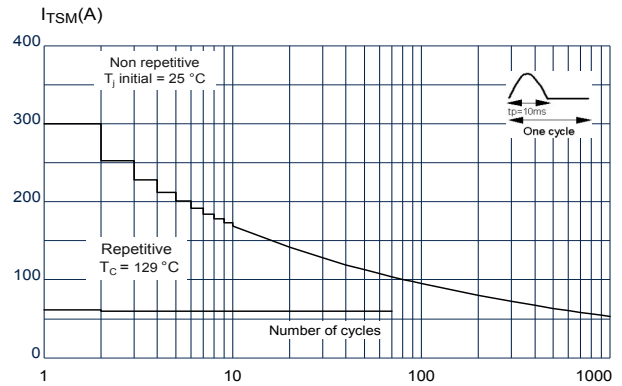

**Figure 9. Non repetitive surge peak on-state current for a sinusoidal pulse with width  $t_p < 10$  ms**

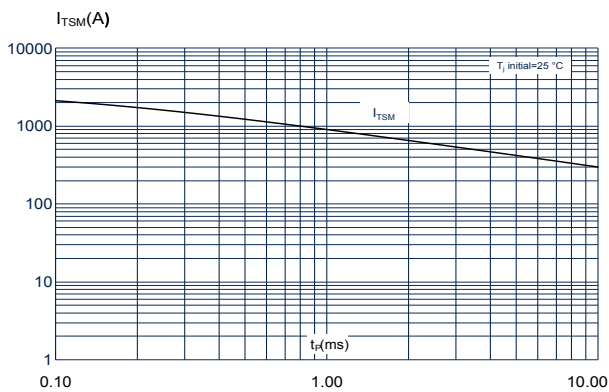

**Figure 10. On-state characteristics (maximum values)**

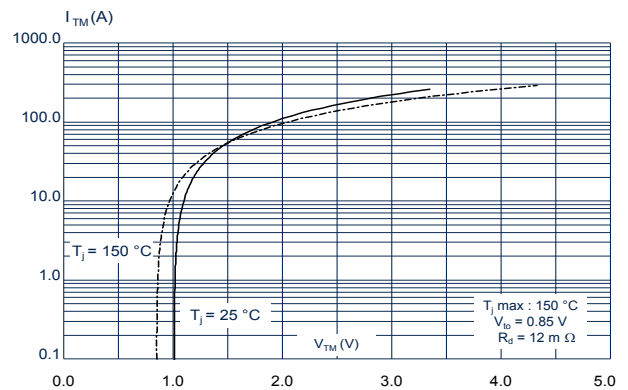

**Figure 11. Relative variation of leakage current versus junction temperature**

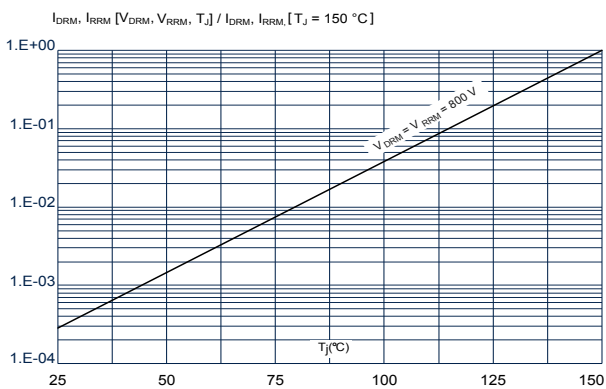

**Figure 12. Recommended maximum case-to-ambient thermal resistance versus ambient temperature for different peak off-state voltages**

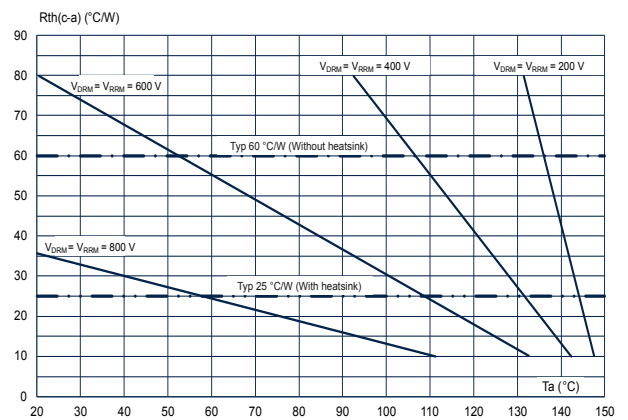

## 2 Package information

To meet environmental requirements, ST offers these devices in different grades of **ECOPACK** packages, depending on their level of environmental compliance. ECOPACK specifications, grade definitions, and product status are available at: [www.st.com](http://www.st.com). ECOPACK is an ST trademark.

### 2.1 TO-220AB package information

- Molding compound resin is halogen-free and meets flammability standard UL94 level 0
- Lead-free package leads finishing
- **ECOPACK2** compliant
- Recommended torque value: 0.55 N·m
- Maximum torque value: 0.70 N·m

**Figure 13. TO-220AB package outline**

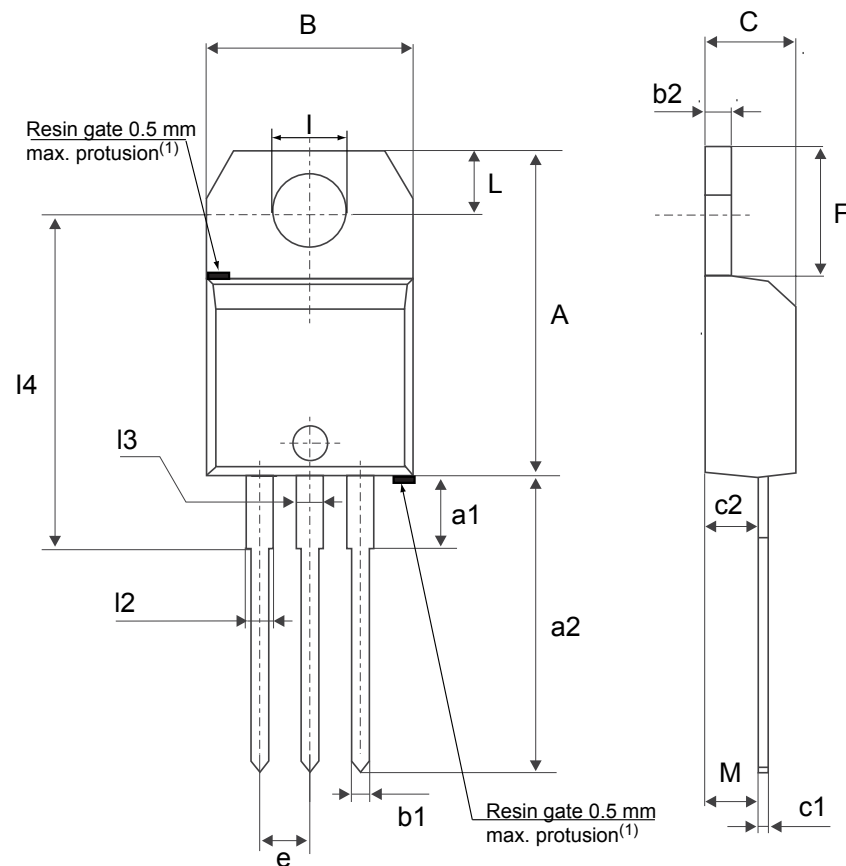

(1) Resin gate position accepted in one of the two positions or in the symmetrical opposites.

**Table 5. TO-220AB package mechanical data**

Ref.	Dimensions					
	Millimeters			Inches <sup>(1)</sup>		
	Min.	Typ.	Max.	Min.	Typ.	Max.
A	15.20		15.90	0.5984		0.6260
a1		3.75			0.1476	
a2	13.00		14.00	0.5118		0.5512
B	10.00		10.40	0.3937		0.4094
b1	0.61		0.88	0.0240		0.0346
b2	1.23		1.32	0.0484		0.0520
C	4.40		4.60	0.1732		0.1811
c1	0.49		0.70	0.0193		0.0276
c2	2.40		2.72	0.0945		0.1071
e	2.40		2.70	0.0945		0.1063
F	6.20		6.60	0.2441		0.2598
I	3.73		3.88	0.1469		0.1528
L	2.65		2.95	0.1043		0.1161
I2	1.14		1.70	0.0449		0.0669
I3	1.14		1.70	0.0449		0.0669
I4	15.80	16.40	16.80	0.6220	0.6457	0.6614
M		2.6			0.1024	

1. Inch dimensions are for reference only.

### 3 Ordering information

Figure 14. Ordering information scheme

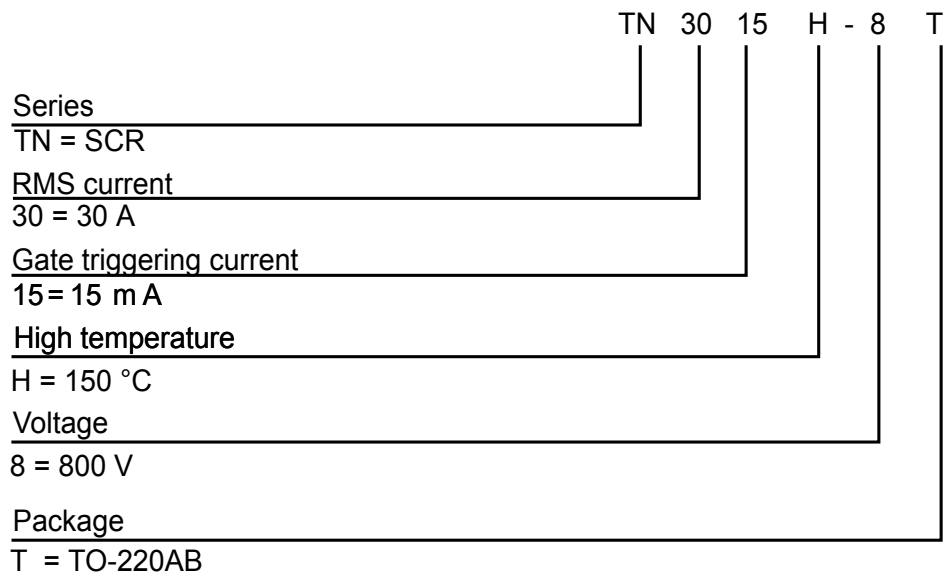

Table 6. Ordering information

Order code	Marking	Package	Weight	Base qty.	Delivery mode
TN3015H-8T	TN3015H8T	TO-220AB	1.9 g	50	Tube

## Revision history

**Table 7. Document revision history**

Date	Revision	Changes
03-Feb-2025	1	Initial release.

**IMPORTANT NOTICE – READ CAREFULLY**

STMicroelectronics NV and its subsidiaries (“ST”) reserve the right to make changes, corrections, enhancements, modifications, and improvements to ST products and/or to this document at any time without notice. Purchasers should obtain the latest relevant information on ST products before placing orders. ST products are sold pursuant to ST’s terms and conditions of sale in place at the time of order acknowledgment.

Purchasers are solely responsible for the choice, selection, and use of ST products and ST assumes no liability for application assistance or the design of purchasers’ products.

No license, express or implied, to any intellectual property right is granted by ST herein.

Resale of ST products with provisions different from the information set forth herein shall void any warranty granted by ST for such product.

ST and the ST logo are trademarks of ST. For additional information about ST trademarks, refer to [www.st.com/trademarks](http://www.st.com/trademarks). All other product or service names are the property of their respective owners.

Information in this document supersedes and replaces information previously supplied in any prior versions of this document.

© 2025 STMicroelectronics – All rights reserved